

PHILIPS TECHNICAL LIBRARY

Series of books  
on  
**ELECTRONIC VALVES**

**BOOK III**

In this series of books on electronic valves there will appear:

- Book I Ir. J. Deketh: *Fundamentals of radio valve technique* (570 pages)
- Book II *Data and circuits of radio valves*, containing the valves brought out in the years 1933/39 (400 pages)
- Book III *Data and circuits of receiver and amplifier valves* (1st supplement), containing the valves of the years 1940/41
- Book III<sup>A</sup> *Data and circuits of modern receiver and amplifier valves* (2nd supplement), containing the valves of the post-war years 1945/1948
- Book IV Dr. B. G. Dammers, J. Haantjes, J. Otte, Ir. H. van Suchtelen: *Applications of electronic valves in radio sets and amplifiers* (Chapters I-V) (460 pages)
- Book V *Applications of electronic valves in radio sets and amplifiers* (Chapters VI-IX)
- Book VI *Applications of electronic valves in radio sets and amplifiers* (Chapters X-XIV)
- Book VII Ir. P. J. Heyboer: *Transmitting valves* (350 pages)

# DATA AND CIRCUITS

OF

## RECEIVER AND AMPLIFIER VALVES

(1st SUPPLEMENT)

This publication furnishes a review, with full descriptions and data, of receiver, amplifier and rectifier valves developed in the years 1940 and 1941, together with their applications and circuits. A large variety of receiver circuits incorporating the valves under review are also provided and this book further contains a description of measuring and auxiliary instruments for use both in the laboratory and on the plant as at 1st January 1942.

**1949**

PUBLISHED BY  
N.V. PHILIPS' GLOEILAMPENFABRIEKEN (PHILIPS INDUSTRIES)  
EINDHOVEN, NETHERLANDS  
Technical & Scientific Literature Department

- Sole distributors for the U.S.A. and Canada:* ELSEVIER BOOK COMP. INC.  
215 Fourth Avenue  
NEW YORK
- for the United Kingdom and Eire:* CLEAVER HUME PRESS LTD.  
422 South Audley Street  
LONDON W. 1.
- for Holland — Norway and Sweden:* MEULENHOF & Co., N.V.  
Beulingstraat 2-4  
AMSTERDAM
- for Denmark:* JUL. GJELLERUP'S BOGHANDEL  
Solvgade 87  
KOBENHAVN K.
- for India:* PHILIPS ELECTRICAL CO (INDIA) LTD.  
Philips House — Heysham Road.  
CALCUTTA 20
- for South Africa:* SOUTH AFRICAN PHILIPS (PTY) LTD.  
Upper Railway Road  
Corner Herb Street  
Doornfontein  
JOHANNESBURG
- for Australia:* PHILIPS ELECTRICAL INDUSTRIES  
OF AUSTRALIA (PTY) LTD.  
Philips House  
69-73 Clarence Street  
SYDNEY.
- for New Zealand:* PHILIPS ELECTRICAL INDUSTRIES  
OF NEW ZEALAND LIMITED  
Nimmo's Building  
Corner Willis — Bond Streets  
WELLINGTON. C. 1
- for other countries:* N.V. PHILIPS' GLOELAMPENFABRIE-  
KEN, EINDHOVEN.  
Holland.  
Technical and Scientific Lit. Dept.

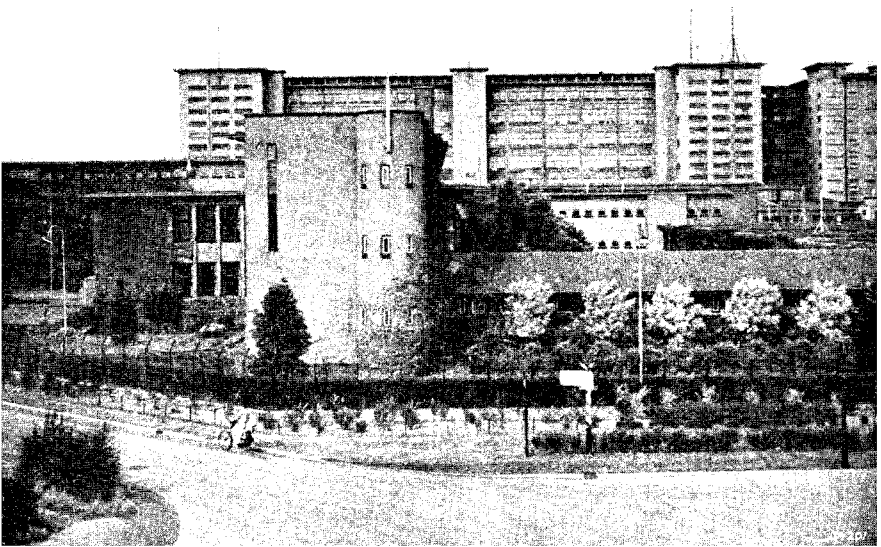

View of the Philips Laboratories for Scientific Research at Eindhoven

Translated by:  
G. DUCLOUX — SUTTON (ENGLAND)

All data included in this book are given without prejudice in respect  
of the patent rights of  
N.V. PHILIPS GLOEILAMPENFABRIEKEN  
Printed in Holland.

## PREFACE TO ENGLISH EDITION

As a result of the war the English version of this book is being published six years later than the original Dutch edition. In this book the reader will therefore find some types of valves described which in the meantime have become obsolete, such as the DM 21, DHH 50 and the UY 21. These types could not be omitted however because Parts II, III and IIIa are intended to give a historical review of the development of European radio valves. Meanwhile the milestone referred to in the first preface has been passed and with the Rimlock series of valves yet another milestone has been reached. This Rimlock series, with smaller dimensions than the key valves, will be described in more detail in the second supplement (Book IIIa),

January, 1949.

## FOREWORD TO THE DUTCH EDITION

In consequence of the great interest with which Books I and II of the Philips' Series on Electronic Valves have been received, it has not been possible to take into account new types of valves which have made their appearance in the interim, owing to the urgent demand for further editions. The object of this work is to bridge the gap.

This supplement, Book III, deals in the first place with the new "all-glass" type, which has established a milestone in the history of the radio valve and which by reason of its practical construction and the very limited number of types in which it occurs — capable nevertheless of fulfilling every requirement — has greatly simplified the work of the radio manufacturer.

The second series of valves described in Book III is the so-called D-series, a range of valves designed to work on 1.4 V heater voltage. These valves have solved the problem of the economical battery set.

The 100 mA AC/DC series (U-series) and two 6.3 V types, namely the ECH 4 and EL 50 in a category of their own, are also described.

The following pages naturally include once more a number of receiver circuits, as this is the most practical method of illustrating the best means of employing the valves.

In contrast with Book II, in which such circuits formed part of a separate section, the circuit diagrams are now included in the respective chapters on each particular series of valves.

Lastly, this work introduces in brief the latest measuring instruments of interest both to the manufacturer of receivers and to the research worker.

January 1943.



# INDEX

## FOREWORD

## INDEX

### PHILIPS "MINIWATT" KEY VALVES

The new E and U series . . . . .	Page	3
The EBL 21 Double-diode output pentode . . . . .	"	10
The ECH 21 Triode-heptode . . . . .	"	15
The EF 22 R.F. variable-mu pentode . . . . .	"	27
The new key valves for AC/DC (U series) . . . . .	"	32
The UBL 21 Double-diode output pentode . . . . .	"	33
The UCH 21 Triode-heptode . . . . .	"	39
The UF 21 Variable-mu R.F. pentode . . . . .	"	49
The UY 21 Half-wave rectifier valve . . . . .	"	54

### CIRCUITS OF AC AND AC/DC RECEIVERS BASED ON THE USE OF THE NEW "MINIWATT" KEY VALVES

I. Superheterodyne A.C. receiver with three receiving valves . . . . .	Page	58
II. A.C. superheterodyne 4-valve receiver . . . . .	"	63
III. Three-valve superheterodyne receiver for 220 V AC/DC operation . . . . .	"	67
IV. 4-valve superheterodyne receiver for 110 V and 220 V AC/DC mains operation . . . . .	"	70

### 1.4 VOLT BATTERY VALVES FOR OPERATION ON DRY BATTERIES

The 1.4 V series of Battery Valves for operation on Dry Batteries. . . . .	Page	74
The DAC 21 Diode-triode . . . . .	"	79
The DBC 21 Double-diode-triode . . . . .	"	83
The DF 21 R.F. pentode . . . . .	"	86
The DF 22 variable-mu R.F. pentode . . . . .	"	91
The DK 21 Battery octode . . . . .	"	95
The DL 21 Output pentode . . . . .	"	102
The DLL 21 Double output pentode . . . . .	"	107
The DM 21 Electronic indicator . . . . .	"	117
The DAH 50 Diode heptode with space-charge grid . . . . .	"	119
Applications of the 1.4 V battery valves in universal receivers for AC/DC-battery operation . . . . .	"	124

### CIRCUITS OF BATTERY RECEIVERS

V. Four-valve battery receiver . . . . .	Page	132
VI. Five-valve battery receiver . . . . .	"	135
VII. Four-valve superheterodyne receiver for 110/220 V AC/DC mains and battery operation . . . . .	"	137
VIII. Two-valve battery receiver for use with headphones . . . . .	"	142

### 100 mA VALVES FOR AC/DC RECEIVERS

100 mA valves for AC/DC receivers . . . . .	Page	146
The UBL 1 Double diode-output pentode . . . . .	"	147
The UCH4 Triode-heptode . . . . .	"	152
The UF 9 R.F., I.F. and A.F. pentode . . . . .	"	161

The UM 4 Dual-sensitivity electronic indicator . . . . .	„	166
The UY 1 (N) Half-wave rectifier valve . . . . .	„	170
IX. Four-valve superheterodyne receiver for 220 V AC/DC mains . . . . .	„	172

**TWO VALVES FOR A.C. OPERATION ECH 4 AND EL 50**

The ECH 4 Triode-heptode . . . . .	Page	178
The EL 50 Amplifier for push-pull output stages . . . . .	„	182
X. Universal 26 W amplifier. . . . .	„	191

**LATEST PHILIPS MEASURING AND ANCILLARY EQUIPMENT  
FOR LABORATORIES, TEST-ROOMS AND WORKSHOPS**

Philips signal generator GM 2307. . . . .	Page	200
Philips service oscillator GM 2882 . . . . .	„	203
Philips thermionic voltmeter GM 4132 . . . . .	„	205
Philips stabilised voltage D.C. supply unit type GM 4560 . . . . .	„	207
Philips 5000 V supply unit GM 4198 and projection adapter GM 4199 . . . . .	„	210
Philps "Vibraphil" vibratory converter type GM 4226 . . . . .	„	212

**PHILIPS “Miniwatt”  
key valves**



# Philips "Miniwatt" key valves

The new E and U series

## INTRODUCTION

Thermal electronic or thermionic emission, upon which the evolution of the radio valve is based, was originally discovered in the incandescent electric lamp and it is the reason for the fact that early radio valves were constructed along the same lines as the electric lamp, this principle being characterised primarily by the "pinch" method of construction.

Although the pinch is a logical element in the design of the lamp, it is however by no means the ideal arrangement for radio valves from the aspect of radio frequency work. In recent years, therefore, numerous manufacturers of radio valves have directed much effort to finding an alternative to the pinch mode of assembly that would better serve the requirements imposed upon it by radio frequencies. The Philips factories have provided the solution in the shape of the so-called key valve. In this, the pinch is replaced by a flat glass base upon which the complete electrode assembly is mounted, the bulb proper being fitted over the assembly and sealed to the rim of this base. In this way, all the electrodes are brought out at one end of the valve, that is, through the base only, and connections between the electrodes and their respective contact pins are kept as short as possible.

### *Description of the construction.*

Fig. 3 shows a drawing of the all-glass type of triode-heptode ECH 21. The electrode system is mounted on a circular glass base (see also Fig. 2), into elevations of which eight leading-in pins are sealed in such a way as to be quite vacuum-tight; these pins are disposed in a circle 17.5 mm in diameter and are sufficiently robust (1.27 mm dia)<sup>1)</sup> to serve for purposes of contact in the valve-holder. The electrode system, mounted vertically on the base, is welded directly to these eight pins; the exhaust stem is located in the centre of the circle of pins.

With the exception of the rectifier valve, the electrode system in these all-glass valves is supported at three points by U-shaped supports, and is very rigid.

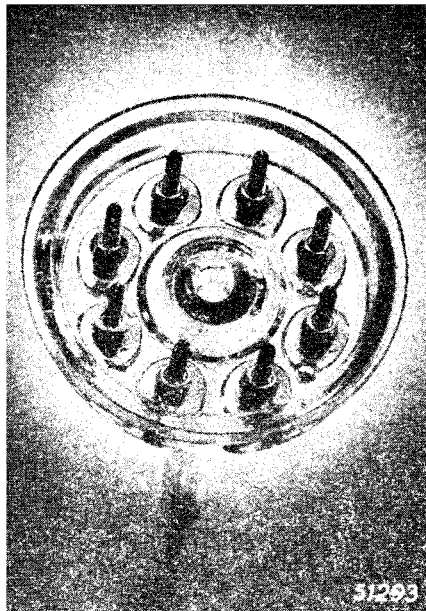

Fig. 2  
Pressed glass base with 8 leading-in pins sealed vacuum-tight in the glass on a circle 17.5 mm in diameter.

<sup>1)</sup> Provisionally, pins 1.1 mm in diameter have been used, but these fit equally well in the existing valve-holders.

1. Bulb.
2. Metal tray to which the getter is attached.
3. Connection of first grid of the heptode section.
4. Screen cage.
5. Top support, of insulating material.
6. First grid of the heptode section.
7. Second grid (screen) of the heptode section.
8. Anode of the heptode section.
9. Third grid of the heptode section.
10. 4th grid (screen) of the heptode section.
11. 5th grid (suppressor) of the heptode section.
12. Centre support, of insulating material.
13. Cathode.
14. Control grid of the triode section.
15. Anode of the triode section.
16. U-shaped screening for the grid lead of the heptode section.
17. Mounting strip for the anode of the triode.
18. One of the U-shaped supports of the electrode system.
19. Closed winding of the triode control grid.
20. Connection of triode anode to contact pin.
21. U-shaped support of electrode system.
22. Bottom support, of insulating material.
23. Ends of the filament.
24. Connecting strip between one end of the filament and the contact pin.
25. Cathode connection
26. Pressed glass base.
27. Spun edge of bottom screen for base and contact pins.
28. Contact pins.
29. Pilot pin.
30. Lug or key on pilot pin.

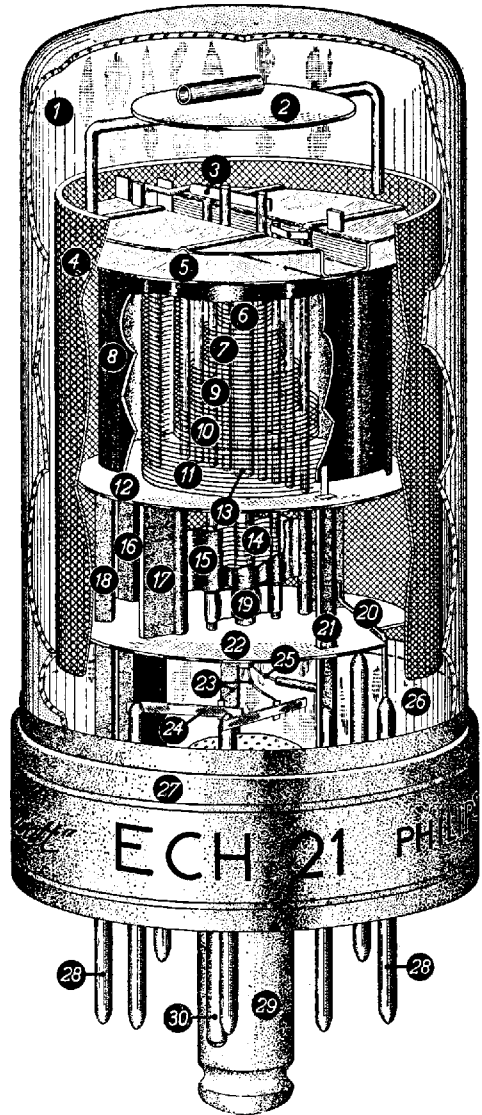

Fig. 3  
Construction of the Miniwatt all-glass Triode-Heptode ECH 21

When the bulb has been sealed to the base, the valve is exhausted and the material absorbing residual gases — the getter — is flashed off.

The getter is located on a plate above the electrode system, so that the mirroring it produces occurs only at the head of the bulb. When the exhaust stem has been sealed off, a screen plate with pilot pin mounted in its centre is attached to the glass base. The pilot pin can also serve as contact pin, if necessary. The metallised layer applied to the glass bulbs of earlier types of valves is now no longer necessary, since screening is effected by a cage (a cylinder of perforated metal foil), placed around the electrode system of the R.F. valves and fixed to this system.

### Advantages of the new design, with connections at one end only.

#### Mechanical advantages.

##### 1) *Smallest possible dimensions of the valve.*

Owing to absence of the pinch, it has been found possible to reduce the length of the valve by an amount equal to the height of the pinch: the height of the EBL 1 is 130 mm, that of the EBL 21 only 80 mm, while the systematic reductions that have been made in dimensions of the electrode systems have helped to reduce the diameter also. The small diameter of the new valves (at most 32mm for all types) has in turn made it possible to design extremely small receivers of high quality and utilising a minimum of material.

The chassis of the receiver, for instance, can be made much smaller than in the past, whilst a further advantage arises from the small diameter of the valve in that the valve-holders need be no larger than the overall dimensions of the valve. With sets of so very much smaller proportions, the total weight is also much less, which provides a considerable saving in material.

##### 2) *Robustness*

Again thanks to disappearance of the pinch, the electrode system can now be mounted very rigidly on the glass base. The system, as usual, is supported between two insulating plates which are in turn held together by three U-shaped brackets arranged in a triangle; these supports are securely welded to three of the contact pins in the glass base, the whole making for a type of construction which will with-

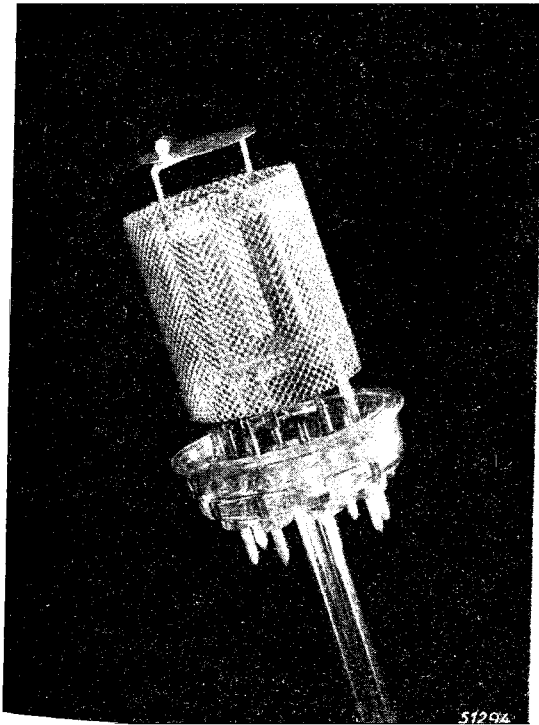

Fig. 4

The electrode system of a key valve with enveloping cage for screening the system; at the top is the getter plate.

stand jarring and vibration in all directions.

An essential feature of the new valve is that the glass base itself takes the place of the base cemented to the bulb in the case of its predecessors and, as the leading-in wires no longer have to be soldered to the pins and to the top-cap formerly employed for the grid connection, the leading-in pins themselves now serving for purposes of contact, interference such as crackle etc, due to faulty soldering is eliminated. The screen plate, with its pilot pin, is spun over the base of the valve and therefore cannot work loose.

### 3) Single-ended connection for all electrodes

Since all the connections to the electrodes are taken through the glass base of the new type of valve, the old form of grid connection at the top of the bulb is no longer required; the anode-to-grid capacitance, however, is no higher than in the older types of valve, since adequate screening is provided within the envelope, thus ensuring that the internal grid lead is sufficiently isolated from the other internal connections and anode mounting at the base of the system. Then again, the metal screen with pilot pin takes care of the bottom screening: the electrode connections of the R.F. pentode EF 22 are so arranged that the pilot pin lies between the anode and grid pins and screens them from each other. The fact that all the connections are at one end of the valve only, places the receiver designer in a position to develop new types of chassis: one direct advantage of the grid connection being at the bottom rather than at the top is that the wiring need no longer be carried through the upper part of the chassis, the resultant arrangement being so much the neater. The absence of screening on grid leads, such as were for-

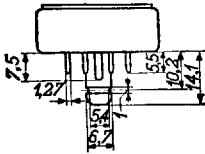
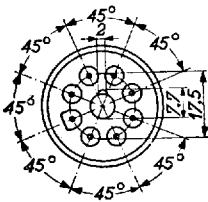

Fig 6  
Main dimensions of the  
new valve base.

51295



Fig. 5  
The base of a key valve, showing the cut-outs for the elevations of the glass base, thereby giving a sufficiently long leakage path between the pins and the screen plate.

merly carried up to the top of the valve, permits a direct saving on cost prices. The layout of the chassis becomes much more logical and screen plates inside the chassis are now much more efficient than in the past. Connections in the chassis can be made by means of very short, rigid wiring which need not be shielded with metal braiding, and parallel capacitances, apart from being constant, are thus reduced to a minimum. It is accordingly possible to utilise the slope of the valve to the fullest extent if so desired.

### 4) The new method of arranging connections

The valve is not equipped with the usual base; the actual glass base serves the same purpose. The arrangement of the eight pins is already indicated on page 3 (cf. Fig. 6). The glass projects through the holes in the metal screen in the form of small protuberances, thus increasing the creepages between pins and screen plate in order to conform to the various official safety regulations.



The pin in the centre of the bottom plate is provided with a lug, or key, to register the valve when it is inserted in the receiver, engaging with a slotted hole in the centre of the valveholder and rendering fitting of the valves an extremely simple matter. It is only necessary to insert the end of the pilot pin in the centre hole of the holder and rotate the valve until the key on the pin slides into the slot. At the lower end of the pin there is a circular groove in which a spring engages when the valve is pressed home, thus locking it firmly in place. By this means it is possible to transport the receiver with the valves in position.

The electrodes are connected to the 8 pins in the circle and, if necessary the pilot pin may also be used as a contact. By no means all valves require 9 pins, but in the triode-heptode it is thus possible to provide separate contacts for the grid of the triode and the 3rd grid of the heptode, making this valve suitable for various purposes other than merely frequency changing. By virtue of this arrangement it has been found possible to limit the number of types in each of the two series, namely AC and AC/DC, to a total of 3.

#### **Electrical advantages.**

The new method of construction also brings with it a number of electrical advantages, namely:

##### *5) Very slight dependence of valve capacitances upon temperature*

The absence of the conventional type of base, of which the dielectric constant is highly dependent on the temperature, means that the capacitive variations, especially during the warming-up period are considerably lower than in the past. Another contributory factor in this direction is the circumstance that the temperature of the glass at the leading-in points does not increase so sharply as in the pinch type of valve, and that the spacing of the leading-in pins is greater.

##### *6) Narrower tolerances in the valve capacitances*

Since all the electrode connections are taken through the base of the valve, the getter-mirror can be placed at the extreme top of the bulb, that is, at a greater distance than normally from the electrodes; the effect of this mirror on the capacitances is therefore very much less marked than formerly and the tolerances in input and output capacitances can be maintained within much finer limits. In valves of the old pinch type of construction the tolerance was  $\pm 0.8$  pF; in the new valves it is only  $\pm 0.4$  pF and these closer tolerances make possible the design of extremely simple and low-priced receivers, since in certain circuits, for instance, trimming condensers may be dispensed with — a great step towards simplicity and economy.

##### *7) Good short wave properties*

The use of sealed-in contact pins has resulted in a great improvement in the short wave qualities of the valves, again by reason of the shorter length of the leading-in wires, or pins and their wider spacing. In earlier types of valve the connections within the pinch run parallel to each other for a distance of 35 mm and not more than 0.5—1 mm apart, with consequent adverse effects upon the short wave reception: in the new valve there is no pinch, each electrode being connected through the shortest possible path to its appropriate contact pin. Capacitive and inductive couplings between the different electrodes are thus reduced to a minimum. In turn, the less marked degree of coupling means that in a mixer valve, for instance, frequency drift due to the gain control is much less than in a corresponding valve with pinch.

## THE NEW SERIES OF VALVES

*Logical choice of types in the E and U series*

The number of different types of valve in use has increased very considerably in recent years, as will be seen from the diagram (Fig. 7).

It will be observed that in 1926 there were only 14 different types, whereas latterly, upwards of 280 varieties have been marketed. In all fairness it should however be added that about one half of these are used in new receivers, whilst the remainder are for the replacement of older types: nevertheless, it is desirable to restrict as far as possible any further increase in the number of current models.

In laying down the number of types to be manufactured it has to be taken into account that all known types of receiver, from the simplest to the most elaborate designs are being manufactured, this being in the interest of both the radio industry and the dealer. To meet these requirements, two series of valves have been designed, namely one for A.C. (the E series) which in accordance with present day standards has a heater voltage of 6.3 V and another for AC/DC (the U series), having a low heater current consumption (100 mA).

Each of these series comprises not more than three types, viz:

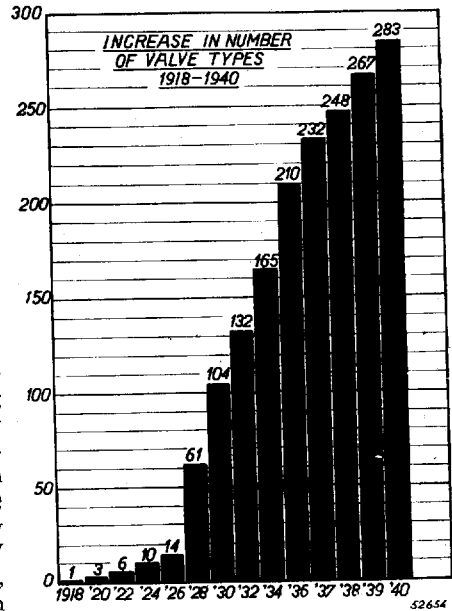

Fig. 7  
Increase in the number of valve types in use.  
Diagram showing the increase in valve types  
between 1918 and 1940.

### 1) *EBL 21 and UBL 21: double-diode output pentodes.*

These are high-slope valves with a maximum anode dissipation of 11 W. The combination of two diodes with output pentode is so arranged that adequate A. F. gain can be obtained between the diodes and the pentode. It is thus possible, in conjunction with other valve types in the same series, to design every conceivable type of circuit, including automatic gain control and feedback.

The design of the pentode section of the UBL 21 gives rise to simple change-over arrangement, the valve being suitable for a working voltage of 100 V as well as of 200 V.

### 2) *ECH 21 and UCH 21: Triode-heptodes.*

The triode and heptode grids have each their own separate connection, and the two sections can therefore be employed for different purposes; the separate connections of all the electrodes have been made possible by the fact that there are in all nine connecting points. Apart from acting as frequency changer, with the triode grid connected to the third grid of the heptode, this valve may also be employed for separate amplification purposes, e.g.:

- the heptode for the I.F. stage and the triode for A.F. amplification;
- the heptode as A.F. amplifier and the triode as phase inverter for a push-pull output stage.

3) *EF 22 and UF 21. Variable-mu pentodes.*

These valves, having sliding screen voltage, can be used as R.F., I.F. and A.F. amplifiers.

In the U series there is also a new indirectly heated half-wave rectifier valve, giving a maximum D.C. output of 140 mA, namely the UY 21.

The above mentioned three types meet all possible requirements on the part of the radio manufacturer and the following examples will give some idea of the types of receiver in which they can be employed.

a) *Small 2-valve superhets.*

To be used: ECH 21—EBL 21,

or: UCH 21—UBL 21 (reflex circuit with diode detection and automatic gain control).

b) *Simple 3 valve superhets.*

To be used: ECH 21—EF 22—EBL 21,

or: UCH 21—UF 21—UBL 21.

c) *High sensitivity superhets.*

To be used: ECH 21—ECH 21—EBL 21,

or: UCH 21—UCH 21—UBL 21.

This arrangement is in no way inferior to earlier 4-valve superheterodyne receivers.

d) *High quality superhets.*

To be used: ECH 21—EF 22—EF 22—EBL 21,

or: UCH 21—UF 21—UF 21—UBL 21.

A receiver designed on this basis meets the same requirements as earlier types of 5-valve receiver.

e) *High grade push-pull output receivers.*

To be used: EF 22—ECH 21—EF 22—ECH 21—2 × EBL 21.

The second ECH 21 serves for A.F. amplification and phase inversion. Three of the four diodes can if desired be employed to make up a 3-diode circuit.

The number of possibilities is not limited to the above, which are only a few examples of the great variety of receiver circuits that can be designed with these few valves.

It is interesting to note that in the U types it is a very simple matter to change over from a 220 V mains system to lower voltages (110—127 V). The valves in this series are so matched that it is not usually necessary to readjust the values of bias, screen and anode resistances, or the output matching; it is quite sufficient to alter the heater current circuit only, and this can be done with very little trouble.

Electronic indicators have not yet been included in this series of valves, but the existing type EM 4 may be used without any objection for A.C. work, or the UM 4 for AC/DC. The following pages contain a description of the various valve types in alphabetical and numerical order.

# EBL 21 Double-diode output pentode

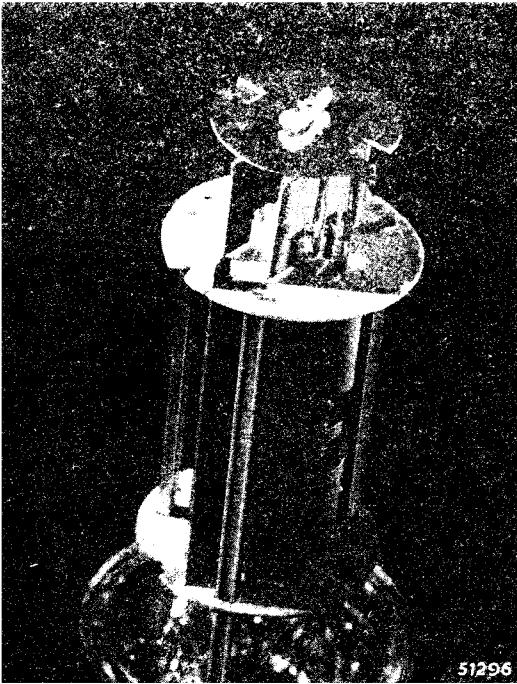

Fig. 1  
Internal assembly of the double diode pentode EBL 21.

a valve of this class when the diode-anode employed for the detection is sufficiently free from ripple to allow of adequate A.F. gain. In the design of the EBL 21 it was made a condition that an A.F. gain factor of 60 between the detector diode and the grid of the output pentode should be obtainable on normal feed by means of a mains-operated heater transformer<sup>1)</sup>. In this way the triode section of the ECH 21, coupled as A.F. amplifier, or the pentode EF 22, may be interposed between the diode and pentode sections of this valve, in the second instance with more or less intensive feedback. A great deal of care has accordingly been paid to the design of the diode section of the valve. Efficient screening and a careful choice of sequence in the electrode connections have resulted in a minimum of ripple voltages at the diode anode  $d_2$  used for detection.

The EBL 21 is also very suitable for Class AB push-pull output

<sup>1)</sup> This figure should be used for guidance only, since a higher gain is possible if greater ripple be permitted. When power is obtained from a vibrator, a gain factor of 15 should be regarded as the limit, since in this case a greater amount of ripple must be expected.

The EBL 21 is a double-diode output pentode. The sensitivity of the pentode system is extremely high; the mutual conductance is 9.5 mA/V. The maximum anode dissipation is 11 W.

Since the dimensions of the electrode system are considerably smaller than those of the earlier EBL 1, the heater current consumed is accordingly lower: at 6.3 V the heater current of the EBL 21 is only 0.8 A, as against 1.18 A in the case of the EBL 1. In many cases it will be possible, in order to increase the A.F. sensitivity of the receiver, to couple an A.F. amplifier between the diode and the pentode of the EBL 21; this is only possible for

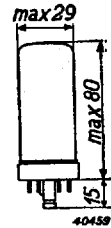

Fig. 2  
Dimensions in mm.

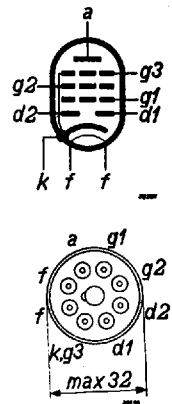

Fig. 3  
Arrangement and connections of the electrodes.

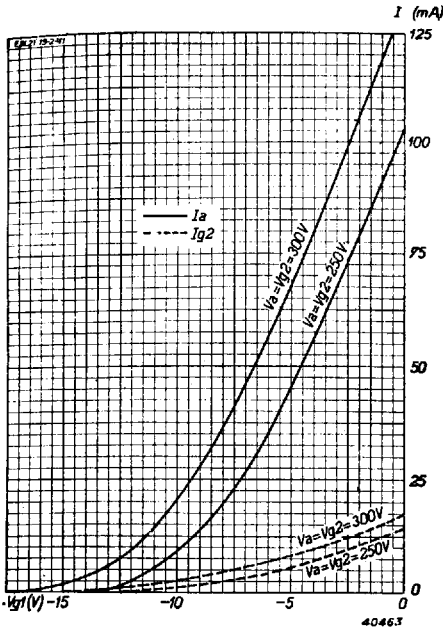

Fig. 4  
Anode and screen current as a function of grid bias at  $V_a = V_{g2} = 250$  V and  $= 300$  V.

stages. Two of these valves in conjunction with a triode heptode ECH 21 coupled as A.F. amplifier and phase inverter give a very high quality output stage having an output of about 13 W. This is an ideal final stage for very high grade receivers. Moreover, 4 diodes of the EBL 21 are then available for employment, for instance, in a 3 diode circuit. To prevent interaction between the diode and pentode sections, the capacitances between the diode anodes and the anode and grid of the pentode have been suppressed as much as possible (see capacitance values included in the operating data). Technical data of this valve are given below:

**HEATER RATINGS**

Heating: indirect; alternating current; parallel supply.

Heater voltage. . . . .  $V_f = 6.3$  V

Heater current. . . . .  $I_f = 0.8$  A

**CAPACITANCES**

a) Pentode section

$C_{ag1} < 1.4$  pF

b) Diode sections

$C_{d1k} = 1.8$  pF

$C_{d2k} = 2.0$  pF

$C_{d1d2} < 0.15$  pF

c) Between diode and pentode

$C_{d1g1} < 0.1$  pF       $C_{d1a} < 0.06$  pF

$C_{d2g1} < 0.05$  pF       $C_{d2a} < 0.02$  pF

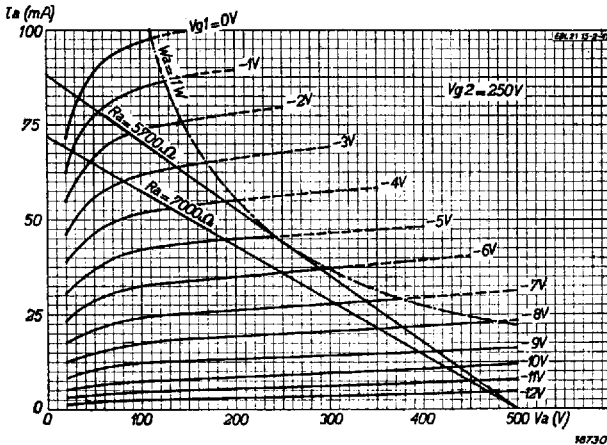

Fig. 5  
Anode current as a function of anode voltage at  $V_{g2} = 250$  V, with grid bias as parameter. In the figure the load lines in respect of  $R_a = 5700$  Ohms (11 W operation) and  $R_a = 7000$  Ohms (9 W operation) are also shown.

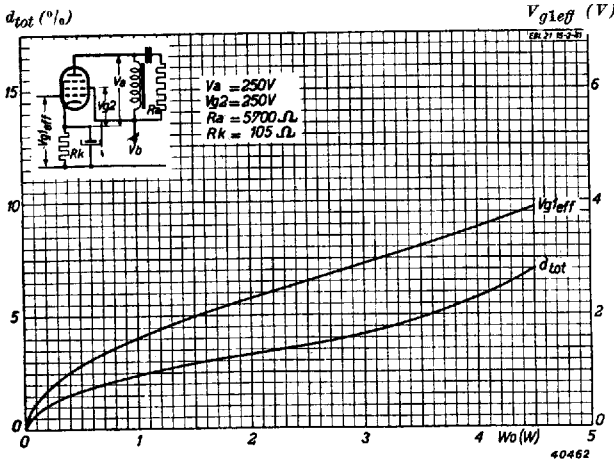

Fig. 6  
Total distortion and required alternating grid voltage as a function of output power at  $V_a = V_{g2} = 250$  V and  $R_a = 5700$  Ohms (11 W operation).

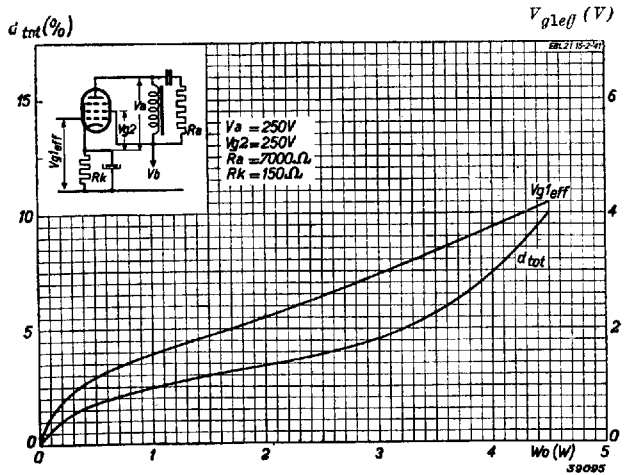

Fig. 7  
Total distortion and required alternating grid voltage as a function of output power at  $V_a = V_{g2} = 250$  V and  $R_a = 7000$  Ohms (9 W operation).

**OPERATING DATA FOR THE PENTODE SECTION employed as single output valve.**

Anode voltage . . . . .	$V_a = 250$ V	250 V
Screen grid voltage . . . . .	$V_{g2} = 275$ V	250 V
Cathode resistance . . . . .	$R_k = 125$ Ohms	150 Ohms
Grid bias . . . . .	$V_{g1} = -6.2$ V	-6 V
Anode current . . . . .	$I_a = 44$ mA	36 mA
Screen grid current . . . . .	$I_{g2} = 5.8$ mA	4.5 mA
Mutual conductance . . . . .	$S = 9.5$ mA/V	9.0 mA/V
Internal resistance . . . . .	$R_i = 50,000$ Ohms	50,000 Ohms
Optimum load . . . . .	$R_a = 5700$ Ohms	7000 Ohms
Output power at max. modulation . . . . .	$W_o = 5.5$ W	4.5 W
Total distortion . . . . .	$d_{tot} = 10$ %	10 %
Required alternating grid voltage for max. modulation . . . . .	$V_{g1eff} = 4.5$ V	4.2 V
Sensitivity ( $W_o = 50$ mW) . . . . .	$V_{g1eff} = 0.30$ V	0.35 V
Gain factor: screen grid — grid 1 . . . . .	$\mu_{g2g1} = 23$	23

**OPERATING DATA for Class AB push-pull output (2 valves)**

Anode voltage . . . . .	$V_a = 300$ V
Screen grid voltage . . . . .	$V_{g2} = 300$ V
Cathode resistance . . . . .	$R_k = 130$ Ohms
Optimum load . . . . .	$R_{aa'} = 9000$ Ohms
Standing anode current . . . . .	$I_{a0} = 2 \times 30$ mA
Anode current at max. modulation . . . . .	$I_{amax} = 2 \times 36$ mA
Standing screen grid current . . . . .	$I_{g20} = 2 \times 3.8$ mA
Screen grid current at max. modulation . . . . .	$I_{g2max} = 2 \times 6.5$ mA
Max. output power . . . . .	$W_{omax} = 13.2$ W
Total distortion at max. output power . . . . .	$d_{tot} = 1.8$ %
Required alternating grid voltage, per grid . . . . .	$V_{g1eff} = 7.0$ V
Sensitivity ( $W_o = 50$ mA) . . . . .	$V_{g1eff} = 0.3$ V

**MAXIMUM RATINGS for the pentode section**

Anode voltage, in cold condition . . . . .	$V_{a0} = \text{max. } 550$ V
Anode voltage . . . . .	$V_a = \text{max. } 300$ V
Anode dissipation . . . . .	$W_a = \text{max. } 11$ W
Screen grid voltage, in cold condition . . . . .	$V_{g20} = \text{max. } 550$ V
Screen grid voltage . . . . .	$V_{g2} = \text{max. } 300$ V
Screen grid dissipation, unmodulated valve ( $V_{g1eff} = 0$ V) . . . . .	$W_{g2} = \text{max. } 1.7$ W
Screen grid dissipation at max. modulation ( $W_o = \text{max.}$ ) . . . . .	$W_{g2} = \text{max. } 3.5$ W
Cathode current . . . . .	$I_k = \text{max. } 60$ mA
Grid current commences at ( $I_{g1} = +0.3 \mu\text{A}$ ) . . . . .	$V_{g1} = \text{max. } -1.3$ V
Max. external resistance between control grid and cathode . . . . .	$R_{g1k} = \text{max. } 1$ M Ohm
Max. external resistance between heater and cathode . . . . .	$R_{fk} = \text{max. } 5000$ Ohms
Max. potential between heater and cathode . . . . .	$V_{fk} = \text{max. } 50$ V

**MAXIMUM ratings for the diode section**

Peak voltage on diode 1 . . . . .	$V_{d1} = \text{max. } 200$ V
Peak voltage on diode 2 . . . . .	$V_{d2} = \text{max. } 200$ V
Max. direct current through resistor of diode 1 . . . . .	$I_{d1} = \text{max. } 0.8$ mA
Max. direct current through resistor of diode 2 . . . . .	$I_{d2} = \text{max. } 0.8$ mA
Diode current commences ( $I_{d1} = +0.3 \mu\text{A}$ ) . . . . .	$V_{d1} = \text{max. } -1.3$ V
Diode current commences ( $I_{d2} = +0.3 \mu\text{A}$ ) . . . . .	$V_{d2} = \text{max. } -1.3$ V

APPLICATIONS

The following points should be borne in mind in the applications of this valve.

(I) Grid bias should be obtained exclusively by use of a cathode resistance. If required, so-called semi-automatic bias may be applied, but only when the cathode current of this valve exceeds 50 % of the total current flowing through the resistance used to provide the bias: the grid leak should then be correspondingly lower in value than the indicated maximum value. (II) Leads to the electrodes should be kept as short as possible. (III) To avoid parasitic oscillation, which, due to the high mutual conductance, very quickly sets in, a damping resistance of, say, 1000 Ohms may be included in the control grid lead; this resistance is to be mounted as closely as possible to the electrode concerned and must not be bypassed by a condenser.

For use of the EBL 21 with feedback, in conjunction with the ECH 21, see also p. 17, in connection with the ECH 21.

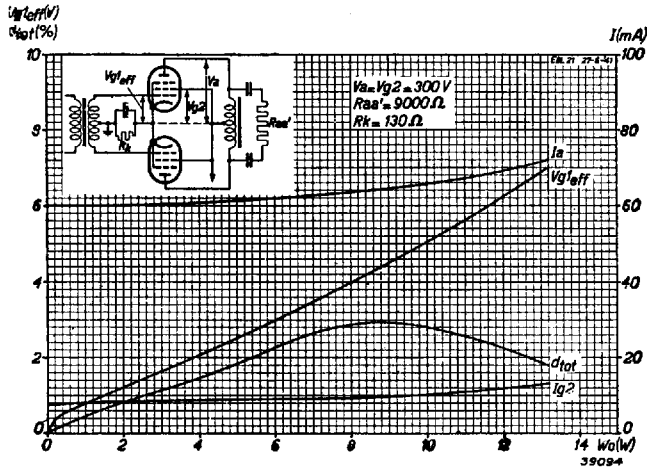

Fig. 8  
Total anode and screen current, total distortion and required alternating grid voltage (per grid) as a function of output power of two valves EBL 21 in a class AB push-pull circuit, at  $V_a = V_{g2} = 300 V$ .



# ECH 21 triode heptode

The ECH 21 is a variable- $\mu$  triode-heptode intended for A.C. supply. The two electrode systems employ a common cathode, consuming approximately 2.1 W.

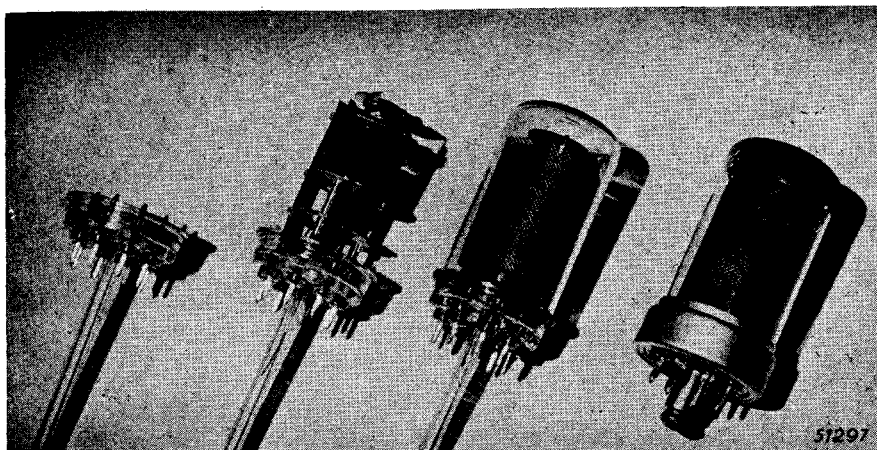

Fig. 1  
Four stages in assembly of the triode-heptode all-glass valve ECH 21.

The ECH 21 is recommended primarily as a frequency changer and as such has the following advantages:

a) *Mixer section constructed as heptode*

The fifth grid of the heptode section is a suppressor grid, to neutralize any adverse effects of secondary emission from the screen and anode. It is therefore possible to apply sliding screen grid voltage, without affecting the internal resistance of the valve; in other words, the screens may be fed from the source of anode voltage through a series-resistance. This not only saves the use of another resistance, but also saves current, in that no potentiometer network is required. The suppressor also ensures a low noise level, since the 4th grid emits no secondary electrons.

b) *High mutual conductance.*

750  $\mu\text{A}/\text{V}$  at low anode current (3 mA).

This relation between the slope and the anode current is again an advantage from the aspect of noise.

c) *Low cross modulation.*

This is ensured by feeding the screen through a series-resistance.

d) *Low frequency drift on short waves.*

Due to the very small amount of frequency drift, it is possible to control very effectively the mutual conductance in the short wave range. At a wavelength of 15 m and employing a tuning capacitance of 50 pF in the oscillator circuit, the drift at maximum control is less than 1.5 kc/s, provided the inductance effect is suppressed as much as possible, e.g. by means of a compensating condenser.

e) *The slope of the triode is very high at the point where oscillation starts (3.2 mA/V).*

Oscillation is accordingly reliable, even under the most unfavourable conditions.

f) *Very steep grid current characteristic of the triode section.*

“Squegging-oscillation” is easily avoided and more latitude is thus provided in the choice of grid condenser and leak.

In the ECH 21 the grid of the triode is not shorted to the 3rd grid of the heptode as

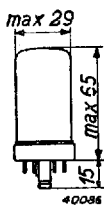

Fig. 2  
Dimensions in mm.

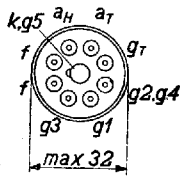
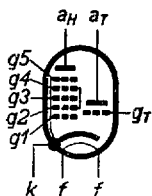

Fig. 3  
Order of connection  
of the electrodes.

in the ECH 3; each grid has its own separate terminal and the range of application of the valve is accordingly very much greater. Its uses as mixing valve have already been mentioned; in this case the grids concerned are interconnected. When the grids are not joined the heptode section can be employed as a variable-mu I.F. amplifier and the triode part as resistance-capacitance (R—C) coupled A.F. amplifier. It is then of course essential to avoid any capacitive and / or inductive coupling between the two systems, and the design of the ECH 21 ensures this to a very high degree. The possibility of employing this valve as I.F. and A.F. amplifier is an outstanding feature, since in the same series of valves a double diode output pentode (EBL 21) can be used with it. In this way a superheterodyne receiver employing only three valves can be made to have the same characteristics as a normal 4-valve set; for instance, the receiver may be equipped with two ECH 21 valves and one EBL 21, giving a very high degree of sensitivity; or, if desired, normal sensitivity, with the surplus A.F. gain diverted to provide good A. F. feedback; or alternatively, to permit of a slight reduction in the gain, as in low-priced receivers where coils without trimmers are employed.

Then again, the ECH 21 provides a good solution in the matter of gramophone amplification in simple receivers, since the output valve is then preceded by an A.F. stage, guaranteeing ample sensitivity towards the pickup signal.

In this circuit one point must however be watched: the heptode and triode sections of the valve share a common cathode, so that if the I.F. amplification is controlled (heptode side) the cathode current drops. At the same time this current determines the grid bias of the A.F. side and this potential is accordingly reduced when the control voltage increases. This is, of course, not desirable and

can be avoided in various ways, a very economical method being the one illustrated in Fig. 4. The cathodes of all valves are connected to chassis and the cathode-resistances with their appropriate decoupling condensers are therefore not required. The grid bias for the A.F. amplifier and output valve is then obtained by means of resistances ( $R_1$  and  $R_2$ ) in the negative feed line. This leaves bias to be found for the mixer and I.F. valves, as well as the delay voltage for the automatic gain control, and for this purpose a negative potential is applied to the anode of the A.G.C. diode. This potential is also carried across the A.G.C. system to the grids of the valves to be controlled. Since in this case the grid bias of the I.F. valve and that of the frequency changer are of the same value as the delay voltage, a compromise has to be found between the most suitable A.G.C. delay voltage and the initial voltage of the controlled valves. The circuit III on page 68 illustrates this principle, employing the UCH 21 and UBL 21 valves.

If the requirements of the receiver are on a higher level, this arrangement will naturally not be used, and steps will be taken to ensure the best possible value for the A.G.C. voltage. For example, the voltage drop across the cathode resistance of the output valve may be employed, this potential being applied to the grids of the controlled

valves which in this instance will require a cathode resistance. In order to prevent the anode current of the triode section of the second ECH 21 from being affected by the control, the potentiometer  $R_7$  and  $R_8$  (see Fig. 5) is so arranged that the current flowing through it passes also through the cathode resistance  $R_2$ . The latter resistance then carries the constant current in question, as well as the anode current from the triode section, which is also fairly constant, and the control then affects only the relatively small anode current in the heptode section. This means that the anode current on the triode side is practically independent of the control exercised on the heptode. In this circuit the grid voltage of the triode fluctuates under maximum control of the heptode between  $-2.2$  V and  $-2.9$  V, which is quite permissible. The fact that the third grid of the heptode and the control grid of the triode have each their own separate connections further makes it possible to use the ECH 21 as pre-amplifier and phase inverter, preceding a push-pull output stage. In this case the two sections of the valve are employed as resistance-capacitance coupled A.F. amplifier. This arrangement is not suitable for driving push-pull amplifiers running into grid current, but the range of application of the normal type of push-pull amplifier without grid current is so extensive that this feature of the ECH 21 is sufficiently important. One or other of the two available valve systems must in any case be employed for A.F. amplification and for this purpose we select the heptode, seeing that this provides the greater amount of gain. The triode need then serve only for inversion of the phase of the voltage thus obtained, for which purpose a single time of amplification is sufficient. Feedback is obtained by returning a portion of the anode voltage to the grid of the same valve.

The theoretical circuit is shown in Fig. 6. The voltage  $V_i$  derived from either a diode or a gramophone pickup is applied across the points A and B. A coupling resistance of 200,000 Ohms is included in the anode circuit of the heptode. The screen grids are fed from the 250 V line through a resistance of 0.25 M Ohms. The A.F. gain factor on the heptode side is then about 100 without control, so that the alternating voltage ( $V_{o1}$ ) applied to the grid of the first output valve is 100 times as great as the input voltage  $V_i$ . Furthermore, the alternating voltage across the resistance  $R_1$  is applied to the grid of the triode section across a resistance  $R_4$  of 1 M Ohm. Due to the resistances  $R_5$  and  $R_4$ , the voltage on the grid in question is about one third of the value of the original alternating voltage.

A portion of the resultant potential across  $R_2$  is used for feedback purposes, this being taken through  $R_5$  to

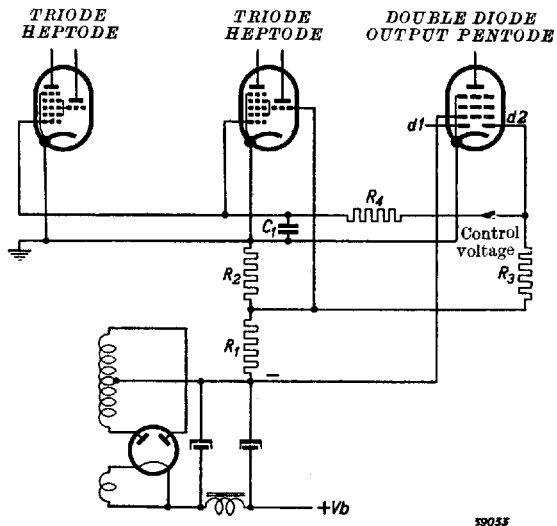

Fig. 4  
Circuit details showing method of obtaining grid bias and automatic gain control, employing the ECH 21 as I.F. and A.F. amplifier with R-C coupling (economical compromise). The voltage drop across the resistances  $R_1$  and  $R_2$  in the negative lead is employed as grid bias for the output valve and I.F. amplifier triode. Part of this voltage is taken by way of the A.G.C. system to the grids of the controlled valves. In this circuit arrangement the voltage obtained is a compromise between the optimum A.G.C. delay voltage and the initial voltage of the controlled valves.

the grid of the triode section and thus superimposed on the existing alternating voltage. In this way the voltage across  $R_2$  as applied to the grid of the second output valve is practically the same as that across  $R_1$ , but  $180^\circ$  out of phase. In absence of control on the valve, this arrangement produces a potential of 10 V for each output valve, with 0.8 % distortion, which is quite sufficient for modulation of two high-conductance EL 6 valves in a push-pull circuit. This type of output circuit can be used to advantage in high-class receivers, and the more so since the diodes of the EBL 21 can then be employed in a three-diode circuit, which is also well-known for the very slight degree of distortion it introduces.

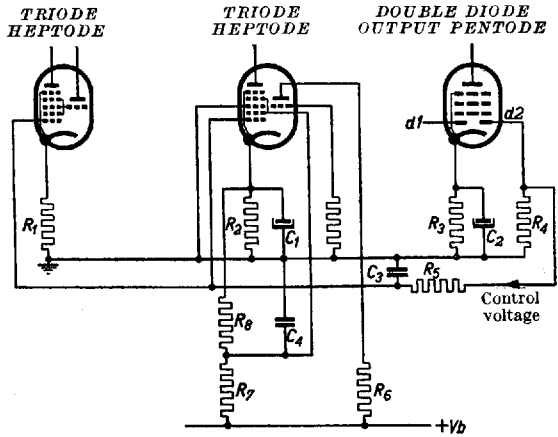

Fig. 5  
Circuit diagram showing method of obtaining grid bias and automatic gain control when using the ECH 21 and EBL 21: the delay voltage for the AGC is now adjusted to the correct value, employing the voltage drop across the cathode resistance  $R_3$  of the output valve. The current flowing through the potentiometer for the screen feed also passes through the cathode resistance of the second ECH 21 and the drop across the latter resistance ( $R_2$ ) is therefore practically independent of the control on the heptode.

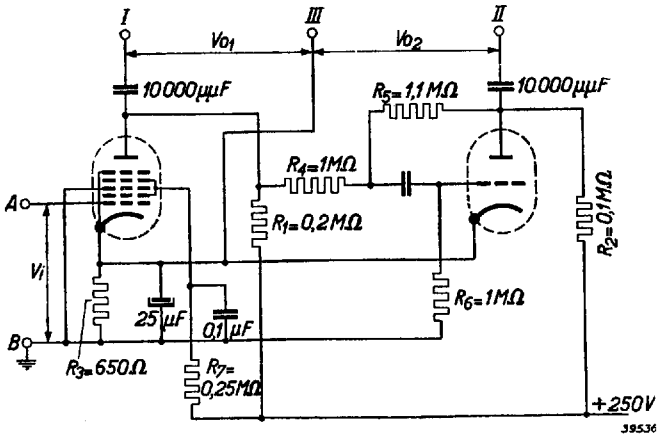

Fig. 6  
Circuit diagram of the ECH 21 employed as A.F. amplifier and phase inverter preceding a push-pull output stage; the output voltages  $V_{o1}$  and  $V_{o2}$  are exactly in counter-phase and are applied to the grids of two output valves. For clarity, the triode and heptode sections are depicted as separate valves.

**HEATER RATINGS**

Feed: indirect, parallel on A.C.

Heater voltage . . . . .  $V_f = 6.3 \text{ A}$   
 Heater current . . . . .  $I_f = 0.33 \text{ A}$

**CAPACITANCES**

a) Heptode section:

$C_{g1} = 6.5 \text{ pF}$                        $C_{g1g3} < 0.3 \text{ pF}$   
 $C_a = 8.0 \text{ pF}$                          $C_{g3} = 8 \text{ pF}$   
 $C_{ag1} < 0.002 \text{ pF}$                  $C_{g1f} < 0.007 \text{ pF}$

b) Triode section:

$C_g = 3.8 \text{ pF}$                          $C_{ak} = 1.6 \text{ pF}$   
 $C_a = 3.1 \text{ pF}$                          $C_{ag} = 1.1 \text{ pF}$   
 $C_{gk} = 2.7 \text{ pF}$                        $C_{gf} < 0.1 \text{ pF}$

c) Between heptode and triode, and both combined:

$C_{gTg1H} < 0.1 \text{ pF}$                  $C_{(gT+g3)g1H} < 0.35 \text{ pF}$   
 $C_{(gT+g3)} = 12.3 \text{ pF}$              $C_{(gT+g3)aH} < 0.1 \text{ pF}$

**OPERATING DATA, HEPTODE SECTION USED as frequency changer (third grid connected to control grid of triode)**

Anode and supply voltage . . . . .  $V_a = V_b = 250 \text{ V}$   
 Screen grid resistance . . . . .  $R_{(g2+g4)} = 24,000 \text{ Ohms}$   
 Cathode resistance . . . . .  $R_k = 150 \text{ Ohms}$   
 Grid leak, third grid and triode grid . . . .  $R_{(g3+gT)} = 50,000 \text{ Ohms}$   
 Current of 3rd grid and triode grid . . . .  $I_{(g3+gT)} = 190 \mu\text{A}$   
 Grid bias . . . . .  $V_{g1} = -2^1) - 24.5^2) \text{ V}$   
 Screen voltage . . . . .  $V_{(g2+g4)} = 100 \text{ 250 V}$   
 Anode current . . . . .  $I_a = 3 \text{ mA}$   
 Screen current . . . . .  $I_{(g2+g4)} = 6.2 \text{ mA}$   
 Internal resistance . . . . .  $R_i = 1.4 > 3 \text{ M Ohm}$   
 Conversion conductance . . . . .  $S_c = 750 \text{ 7.5 } \mu\text{A/V}$   
 Equivalent noise resistance . . . . .  $R_{aeq} = 55,000 \text{ Ohms}$

<sup>1)</sup> Valve not controlled.  
<sup>2)</sup> Conversion conductance controlled to 1/100.

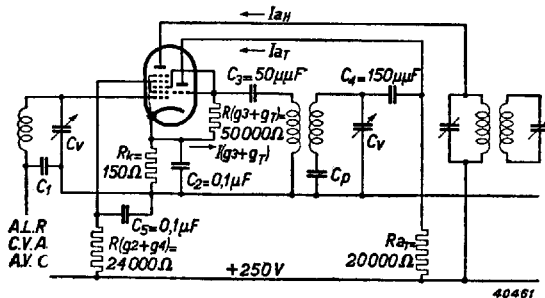

Fig. 7  
 Circuit diagram of the ECH 21 employed as frequency changer.

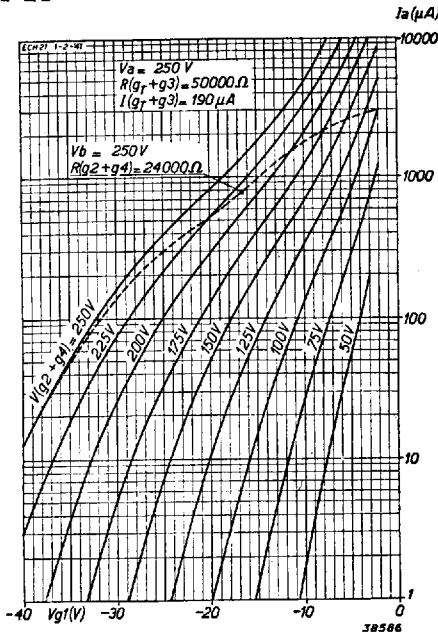

Fig. 8

Anode current of the heptode section as a function of grid bias, at an anode potential of 250 V, with screen voltage as parameter (valve used as frequency changer). The broken line refers to the conditions when the screen is fed across a resistance of 24,000 Ohms.

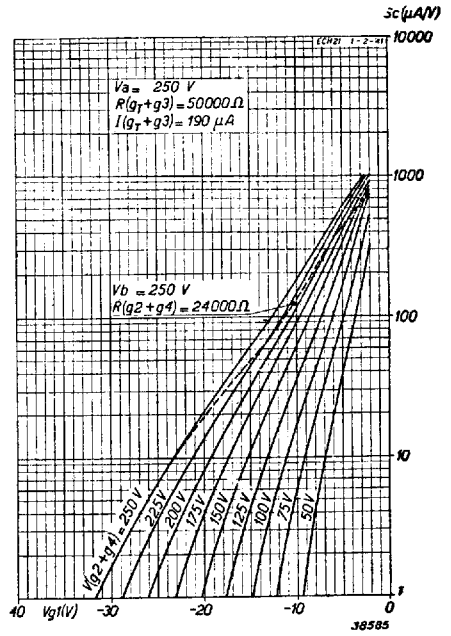

Fig. 9

Conversion conductance  $S_c$  as a function of grid bias  $V_{g1}$ , at an anode potential of 250 V, with screen voltage as parameter. The broken line refers to conditions for screen fed through a resistance of 24,000 Ohms.

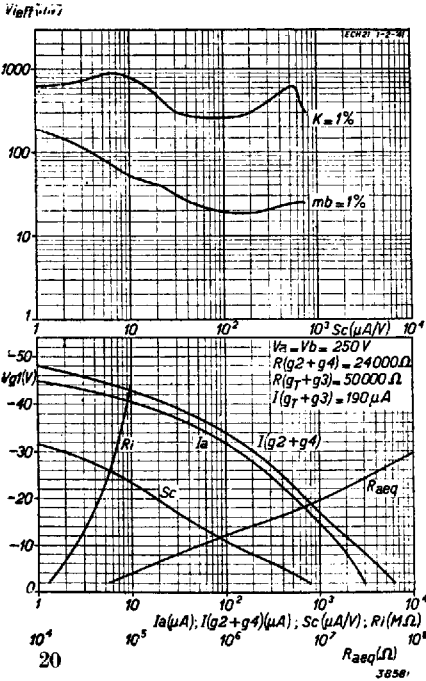

Fig. 10

At  $V_a = V_b = 250$  V and  $R(g_2 + g_4) = 24,000$  Ohms:

Upper diagram; Highest permissible effective value of R.F. alternating voltage for cross modulation of 1 % ( $K = 1\%$ ) and for 1 % modulation hum ( $mb = 1\%$ ), both in respect of the intertering signal at the grid, as a function of the conversion conductance.

Lower diagram; Anode current  $I_a$ , screen current  $I(g_2 + g_4)$ , conversion conductance  $S_c$ , internal resistance  $R_i$  and equivalent noise resistance  $R_{aeq}$ , as a function of the grid bias  $V_{g1}$ .

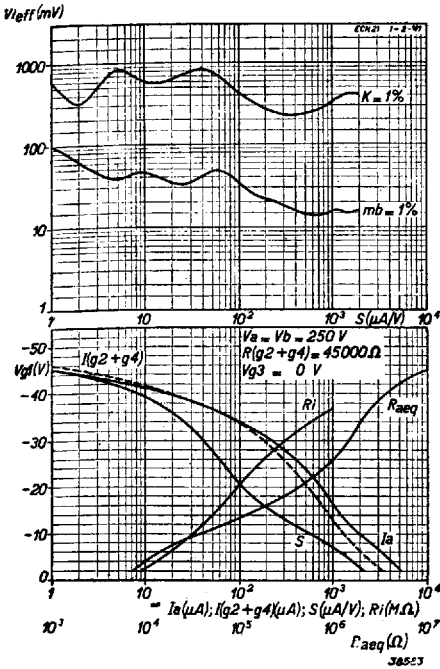

Fig 14  
 The heptode section used as I.F. amplifier at  $V_a = V_b = 250 V$ , with the screen fed across a resistance of 45,000 Ohms.  
 Upper diagram. Highest permissible effective value of R.F. voltage at 1 % cross modulation ( $K = 1\%$ ) and with 1 % modulation hum ( $mb = 1\%$ ), both in respect of the interfering signal on the grid, as a function of the mutual conductance.  
 Lower diagram. Anode current  $I_a$ , screen grid current  $I(g_2 + g_4)$ , mutual conductance  $S$ , internal resistance  $R_i$  and equivalent noise resistance  $R_{aeq}$ , as a function of grid bias.

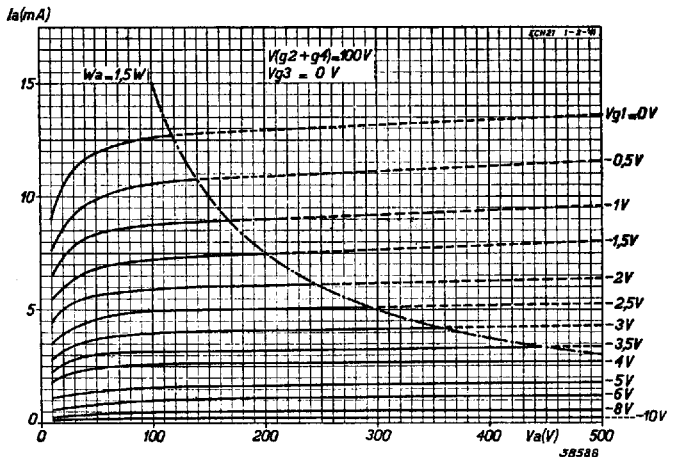

Fig. 15  
 Anode current as a function of anode voltage, with grid bias as parameter, at  $V_{g_2 + g_4} = 100 V$  and  $V_{g_3} = 0 V$ .

**STATIC RATINGS: TRIODE SECTION**

Anode voltage . . . . .	$V_a = 100$ V
Grid bias . . . . .	$V_g = 0$ V
Anode current . . . . .	$I_a = 12$ mA
Mutual conductance . . . . .	$S = 3.2$ mA/V
Gain factor . . . . .	$\mu = 22$

**OPERATING DATA: TRIODE SECTION** used as oscillator valve (triode grid connected to 3rd grid of the heptode section)

Supply voltage . . . . .	$V_b = 250$ V
External anode resistance . . . . .	$R_a = 20,000$ Ohms
Grid leak . . . . .	$R_{(gT+g3)} = 50,000$ Ohms
Current through grid leak to be adjusted to . . . . .	$I_{(gT+g3)} = 190$ $\mu$ A
Anode current . . . . .	$I_a = 4.5$ mA
Effective mutual conductance . . . . .	$S_{eff} = 0.55$ mA/V

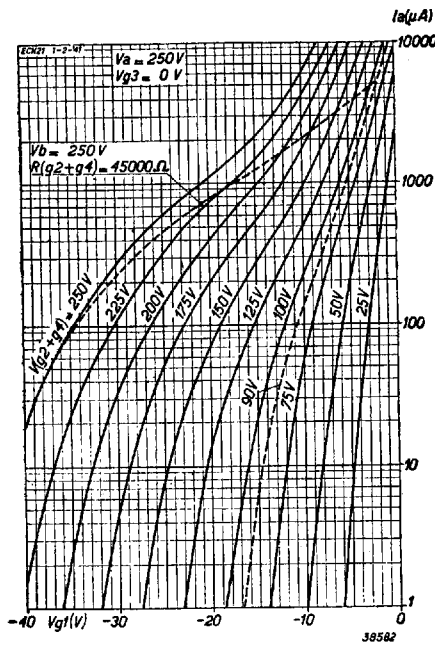

Fig. 12  
The heptode section employed as I.F. amplifier. Anode current as a function of grid bias at  $V_a = 250$  V and  $V_{g_3} = 0$  V with screen voltage as parameter.

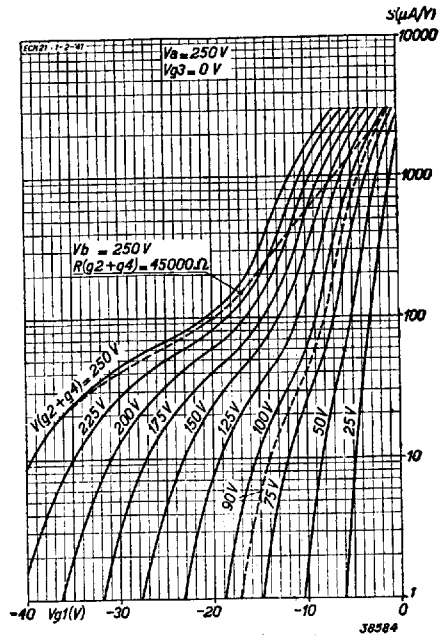

Fig. 13  
Mutual conductance as a function of grid bias of the heptode section at  $V_a = 250$  V and  $V_{g_3} = 0$  V, with screen voltage as parameter.



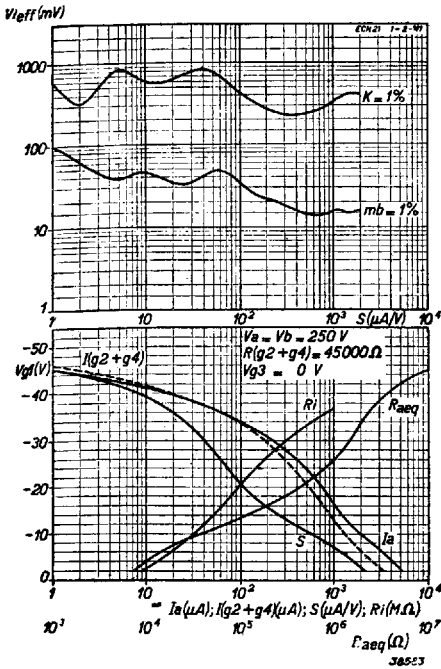

Fig 14  
The heptode section used as I.F. amplifier at  $V_a = V_b = 250 V$ , with the screen fed across a resistance of 45,000 Ohms.

Upper diagram. Highest permissible effective value of R.F. voltage at 1 % cross modulation ( $K = 1\%$ ) and with 1 % modulation hum ( $mb = 1\%$ ), both in respect of the interfering signal on the grid, as a function of the mutual conductance.

Lower diagram. Anode current  $I_a$ , screen grid current  $I(g_2 + g_4)$ , mutual conductance  $S$ , internal resistance  $R_i$  and equivalent noise resistance  $R_{aeq}$ , as a function of grid bias.

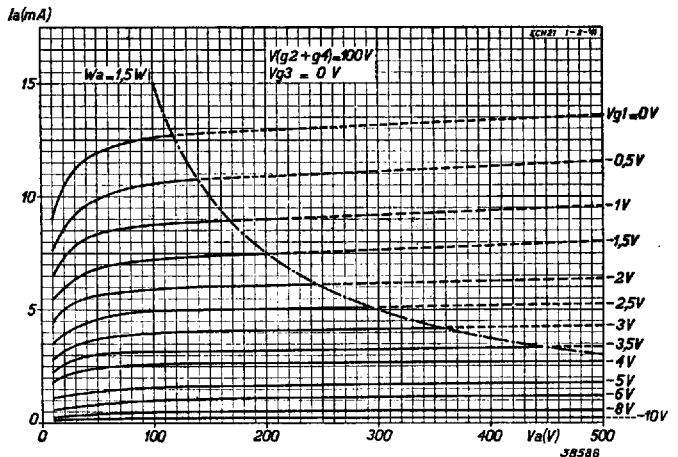

Fig. 15  
Anode current as a function of anode voltage, with grid bias as parameter, at  $V(g_2 + g_4) = 100 V$  and  $V_{g_3} = 0 V$ .

**OPERATING DATA: TRIODE SECTION used as A.F. amplifier with R-C coupling (triode grid not connected to third grid of heptode)**

Supply voltage . . .	$V_b$	=	250	250	250	V			
External anode res. .	$R_a$	=	0.2	0.1	0.05	MOhm			
Grid bias . . . . .	$V_g$	=	-2	-4	-2	-4	V		
Anode current. . . .	$I_a$	=	1.0	0.9	2	1.7	3.5	3	mA
A.C. output voltage .	$V_{oeff}$	=	7.5	7.5	7.5	7.5	7.5	7.5	V
Total distortion . . .	$d_{tot}$	=	2.5	2.0	2.1	1.6	2.1	1.5	%
Voltage gain . . . . .	$\frac{V_{oeff}}{ V_{g1eff} }$	=	13	12	14	13	14	13	

**OPERATING DATA FOR THE ECH 21 used as phase inverter for the modulation of a balanced output stage**

(Arrangement with feedback, see Fig. 16: triode grid not connected to 3rd grid of heptode.)

Supply voltage . . . . .	$V_b$	=	250	V				
External anode resistance: heptode section . . . . .	$R_{aH}$	=	0.2	MOhms				
External anode resistance: triode section . . . . .	$R_{aT}$	=	0.1	MOhms				
Screen grid feed resistance . . . . .	$R_{(g2+g4)}$	=	0.25	MOhms				
Cathode resistance . . . . .	$R_k$	=	650	Ohms				
Neg. control voltage on heptode control grid: . . .	$V_R$	=	0	-5	-10	-15	-20	V
Combined anode current:								
triode and heptode . . . . .	$I_{aH} + I_{aT}$	=	2.5	2.45	2.35	2.25	2.15	mA
Screen grid current . . . . .	$I_{g2+g4}$	=	0.75	0.58	0.43	0.32	0.24	mA
A.C. input voltage . . . . .	$V_{g1eff}$	=	0.10	0.33	0.66	1.0	1.6	V
Voltage gain: . . . . .	$\frac{V_{oeff}}{V_{g1eff}}$	=	100	30	15	10	6	
A.C. output voltage . . . . .	$V_{oeff}$	=	10	10	10	10	10	V
Total distortion . . . . .	$d_{tot}$	=	0.80	3.70	4.50	6.20	7.50	%

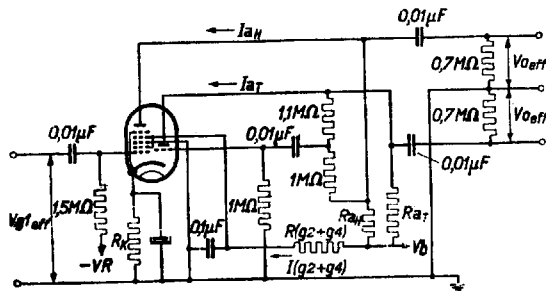

Fig. 16  
Circuit diagram of the ECH 21 employed as phase inverter with feedback, to illustrate the above remarks and symbols.

**MAXIMUM RATINGS FOR THE HEPTODE SECTION**

Anode voltage in cold condition . . . . .	$V_{ao}$	= max. 550 V
Anode voltage . . . . .	$V_a$	= max. 300 V
Anode dissipation . . . . .	$W_a$	= max. 1.5 W
Screen voltage in cold condition . . . . .	$V_{(g2+g4)}$	= max. 550 V
Screen voltage, valve not controlled ( $I_a = 3$ mA).	$V_{(g2+g4)}$	= max. 100 V
Screen voltage, valve controlled ( $I_a < 1$ mA) . .	$V_{(g2+g4)}$	= max. 300 V
Screen grid dissipation. . . . .	$W_{(g2+g4)}$	= max. 1 W
Cathode current. . . . .	$I_k$	= max. 15 mA
Grid current commences ( $I_{g1} = + 0.3 \mu\text{A}$ ) . . . .	$V_{g1}$	= max. $-1.3$ V
Grid current commences ( $I_{g3} = + 0.3 \mu\text{A}$ ) . . . .	$V_{g3}$	= max. $-1.3$ V
Max. external resistance between grid 1 and cathode	$R_{g1k}$	= max. 3 MOhms
Max. external resistance between grid 3 and cathode	$R_{g3k}$	= max. 3 MOhms
Max. external resistance between heater and cathode	$R_{fk}$	= max. 20,000 Ohms
Max. voltage between heater and cathode (D.C. voltage or effective value of the alternating voltage) . . . . .	$V_{fk}$	= max. 50 V

**MAXIMUM RATINGS FOR THE TRIODE SECTION**

Anode voltage in cold condition . . . . .	$V_{ao}$	= max. 550 V
Anode voltage . . . . .	$V_a$	= max. 175 V
Anode dissipation . . . . .	$W_a$	= max. 0.8 W
Grid current commences ( $I_g = + 0.3 \mu\text{A}$ ) . . . .	$V_g$	= max. $-1.3$ V
Max. external resistance in the grid circuit . . . .	$R_{gk}$	= max. 3 M Ohms

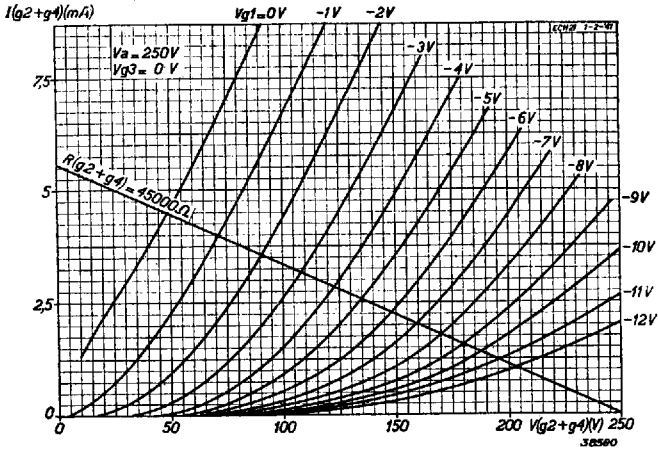

Fig. 17  
Screen current as a function of screen voltage at  $V_a = 250$  V,  $V_{g_3} = 0$  V, with grid bias as parameter.

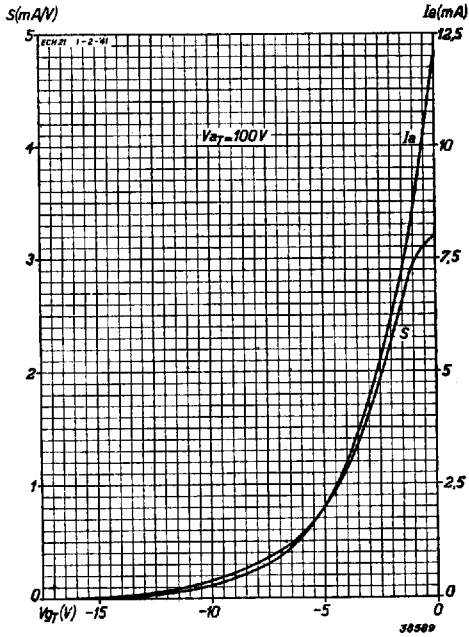

Fig. 18  
Anode current and mutual conductance of the triode section as a function of grid bias, at  $V_{aT} = 100$  V.

# EF 22 R.F. variable MU pentode

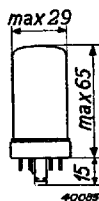

Fig. 1

Dimensions in mm.

The pentode EF 22 is a variable-mu R.F. or I.F. amplifier valve which can also be employed as resistance-capacitance coupled A.F. amplifier. Electrically, this valve is practically identical with the EF 9 in the "red" series: in the EF 22 the screen voltage is also sliding, thus retaining its useful properties with respect to cross modulation etc, even if control is applied. Although the EF 22, in contrast with the EF 8, does not include the extra grid, the equivalent noise resistance is as high as 6,200 Ohms; on this account the EF 22 is admirably suited for use in super-sensitive receivers with R.F. pre-amplification.

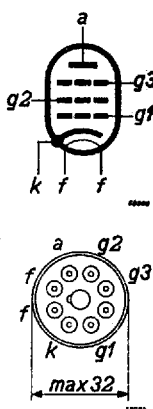

Fig. 2.

Arrangement and sequence of electrode connections.

## HEATER RATINGS

Heating: indirect, AC or DC, parallel.

Heater voltage. . . . .  $V_f = 6.3$  V

Heater current. . . . .  $I_f = 0.2$  A

## CAPACITANCES

$C_{ag1} < 0.002$  pF

$C_a = 6.1$  pF

$C_{g1} = 5.5$  pF

$C_{gf} < 0.004$  pF

## OPERATING DATA: valve used as R.F. or I.F. amplifier

Anode voltage . . . . .	$V_a =$	250 V
Suppressor grid voltage . . . . .	$V_{gs} =$	0 V
Screen grid resistance . . . . .	$R_{g2} =$	90,000 Ohms
Cathode resistance . . . . .	$R_k =$	325 Ohms
Grid bias . . . . .	$V_{g1} =$	-2.5 V <sup>1)</sup> -46 V <sup>2)</sup> -58 V <sup>3)</sup>
Screen voltage . . . . .	$V_{g2} =$	100 V — 250 V
Anode current . . . . .	$I_a =$	6 mA — —
Screen grid current . . . . .	$I_{g2} =$	1.7 mA — —
Mutual conductance . . . . .	$S =$	2200 $\mu$ A/V 22 $\mu$ A/V 4.5 $\mu$ A/V
Internal resistance . . . . .	$R_i =$	1.2 MOhm > 10 MOhm > 10 MOhm
Gain factor in respect of screen grid	$\mu_{gg1} =$	17 — —
Equivalent noise resistance. . . . .	$R_{aeq} =$	6200 Ohms — —

<sup>1)</sup> Valve not controlled.

<sup>2)</sup> Mutual conductance controlled to 1/100.

<sup>3)</sup> Extreme limit of control.

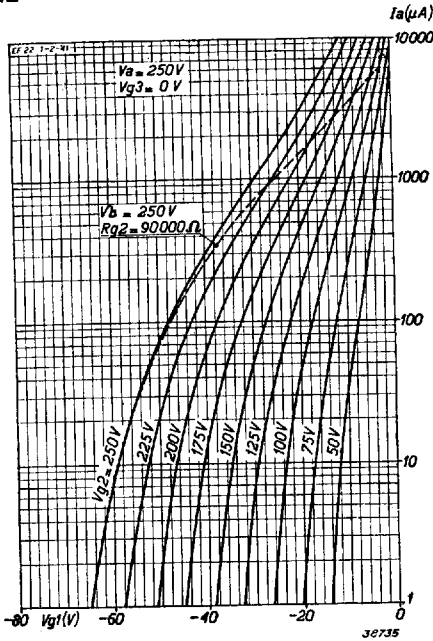

Fig. 3  
Anode current as a function of grid bias at  $V_a = 250$  V and  $V_{g_3} = 0$  V with screen voltage as parameter.

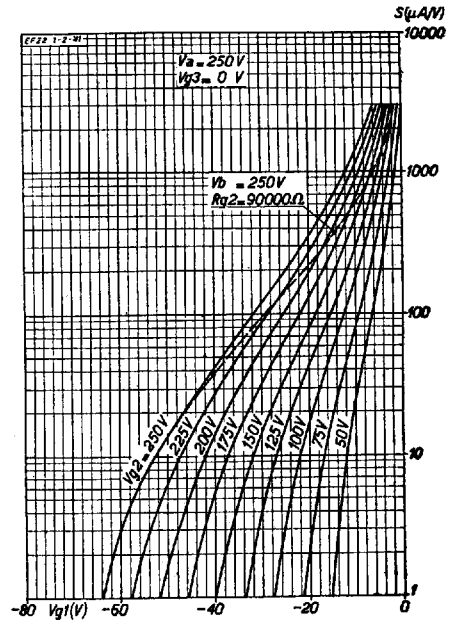

Fig. 4  
Mutual conductance as a function of grid bias at  $V_a = 250$  V and  $V_{g_3} = 0$  V, with screen grid voltage as parameter.

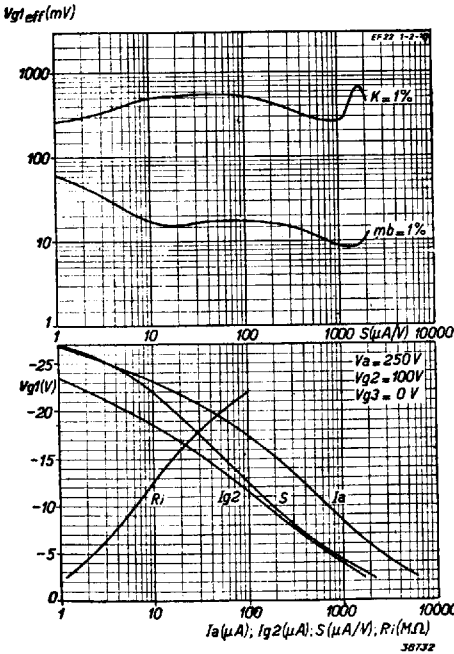

Fig. 5  
At  $V_a = 250$  V,  $V_{g_2} = 100$  V (fixed screen voltage) and  $V_{g_3} = 0$  V.  
Upper diagram; Highest permissible effective value of R.F. alternating voltage with 1 % cross modulation ( $K = 1$  %) and of alternating voltage with 1 % modulation hum ( $mb = 1$  %), in each case in respect to the interfering signal at the control grid, as a function of mutual conductance  
Lower diagram; Anode current  $I_a$ , screen current  $I_{g_2}$ , mutual conductance  $S$  and internal resistance  $R_i$  as a function of grid bias  $V_{g_1}$ .

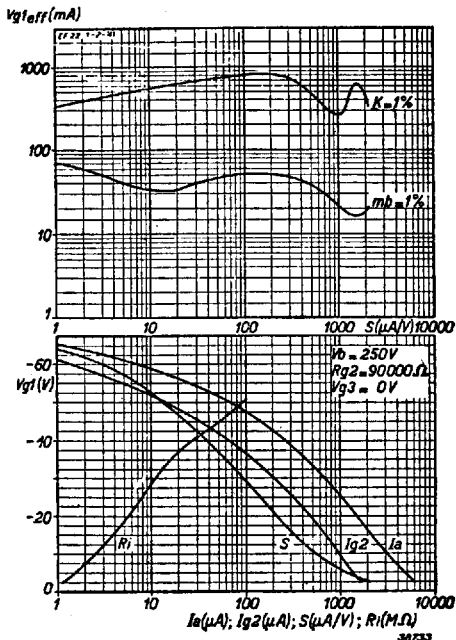

Fig. 6  
 At  $V_b = 250$  V,  $R_{g_2} = 90,000$  Ohms (screen fed across a resistance) and  $V_{g_3} = 0$  V.  
 Upper diagram; Highest permissible effective R.F. alternating voltage with 1% cross modulation ( $K = 1\%$ ) and of alternating voltage with 1% modulation hum ( $mb = 1\%$ ), in each case in respect to the interfering signal at the control grid, as a function of mutual conductance.  
 Lower diagram; Anode current  $I_a$ , screen grid current  $I_{g_2}$ , mutual conductance  $S$  and internal resistance  $R_i$  as a function of the grid bias  $V_{g_1}$ .

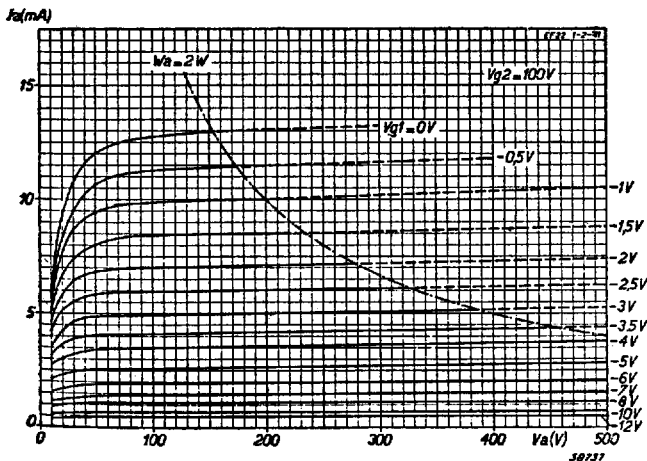

Fig. 7  
 Anode current as a function of anode voltage at  $V_{g_2} = 100$  V, with grid bias as parameter.

OPERATING DATA: valve used as resistance-capacitance coupled amplifier with gain control by means of the control grid.

Supply volts	Anode res. $R_a$ (Mohm)	Screen grid res. $R_{g2}$ (Mohm)	Anode current $I_a$ (mA)	Screen grid current $I_{g2}$ (mA)	Cath. res. $R_k$ (Ohms)	Control volts on grid 1 $-V_R$ (V)	Gain. $\frac{V_{oef}}{V_{g1ef}}$	Required alternating grid voltage and total distortion at an alternating output voltage of:					
								$V_{oef} = 3\text{ V}$		$V_{oef} = 5\text{ V}$		$V_{oef} = 10\text{ V}$	
								$V_{g1ef}$ (V)	$d_{tot}$ (%)	$V_{g1ef}$ (V)	$d_{tot}$ (%)	$V_{g1ef}$ (V)	$d_{tot}$ (%)
250	0.2	0.8	0.87	0.26	1750	0	106	0.028	0.8	0.047	2.4	0.094	2.7
250	0.2	0.8	0.69	0.21	1750	-5	40	0.075	0.8	0.125	2.4	0.25	2.7
250	0.2	0.8	0.55	0.17	1750	-10	23	0.13	1.1	0.22	1.9	0.43	3.7
250	0.2	0.8	0.37	0.11	1750	-18	11.6	0.27	1.5	0.42	2.4	0.86	4.8
250	0.2	0.8	0.17	0.05	1750	-25	6.7	0.45	2.7	0.75	4.4	1.46	8.8
250	0.1	0.4	1.6	0.45	1000	0	85	0.035	0.8	0.059	1.3	0.118	2.5
250	0.1	0.4	1.22	0.36	1000	-5	36	0.083	0.8	0.14	1.4	0.28	2.7
250	0.1	0.4	0.92	0.28	1000	-10	20	0.15	1.2	0.25	2.1	0.49	4.1
250	0.1	0.4	0.57	0.18	1000	-18	9.2	0.33	1.8	0.55	3.1	1.08	6.1
250	0.1	0.4	0.36	0.11	1000	-25	5.5	0.55	2.8	0.91	4.8	1.83	9.5



**MAXIMUM RATINGS**

Anode voltage in cold condition . . . . .	$V_{ao}$ = max. 550 V
Anode voltage . . . . .	$V_a$ = max. 300 V
Anode dissipation . . . . .	$W_a$ = max. 2 W
Screen grid voltage in cold condition . . . . .	$V_{g2o}$ = max. 550 V
Screen grid voltage at $I_a < 3$ mA . . . . .	$V_{g2}$ = max. 300 V
Screen grid voltage at $I_a = 6$ mA . . . . .	$V_{g2}$ = max. 125 V
Screen grid dissipation. . . . .	$W_{g2}$ = max. 0.3 W
Cathode current. . . . .	$I_k$ = max. 10 mA
Grid current commences at ( $I_{g1} = + 0.3 \mu A$ ) . . . . .	$V_{g1}$ = max. $-1.3$ V
Max. external resistance, grid-cathode. . . . .	$R_{g1k}$ = max. 3 MOhms
Max. external resistance, heater-cathode . . . . .	$R_{fk}$ = max. 20,000 Ohms
Max. voltage between heater and cathode. . . . .	$V_{fk}$ = max. 50 V

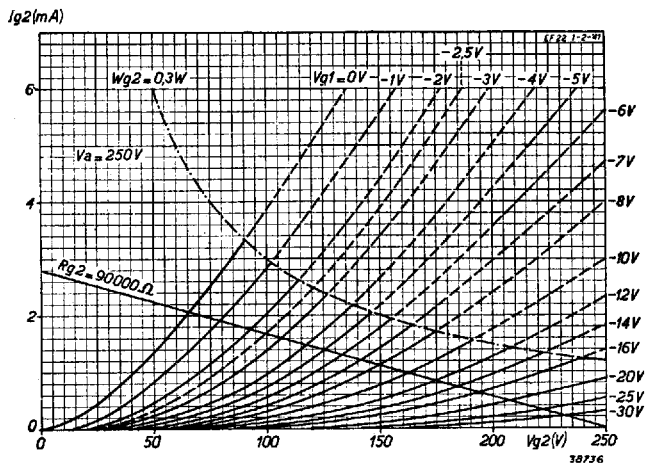

Fig. 8  
Screen current as a function of screen voltage at  $V_a = 250$  V, with grid bias as parameter. The diagram also includes the load line for a screen grid resistance  $R_{g2} = 90,000$  Ohms.

## The new key valves for AC/DC (U series)

In recent years AC/DC receivers have been fitted mainly with the E type valves, consuming a heater current of 200 mA, in conjunction with valves from the C series, also taking 200 mA, for the output stage and rectifier. The heater voltage of the E type valves is 6.3 V and it was formerly necessary always to include a voltage dropping resistance in series with the heaters. In place of a resistance, a regulator valve, or barretter, was frequently used, the advantage of this being that the heater current is kept constant, and modification of the circuit when changing over to another mains voltage is not necessary. Circuits employing E type valves have this disadvantage, however, that much power (about 30 W) is lost in the series resistance or barretter, especially in the case of small receivers having only three or four valves, where a surplus of 125 to 150 volts must be disposed of when the set is run on 220 V mains. For this reason a special range of AC/DC valves, known as the U series, has been developed. The heater current of these valves is 100 mA, which shows a considerable saving in current as compared with the former E or C types, but in order to ensure that the new valves will have the same characteristics as the E types, that is in effect to provide the same heater power, the heater voltage has been increased. In the new type U-valves this voltage has been so chosen as to make possible extremely economical circuits for use on existing mains (chiefly 110—220 V).

In the development of the new valves it has been the object of the designers to make them as similar as possible to their corresponding types in the E series, which means that the main features of the design of a receiver for AC/DC operation may be identical with those used on AC only. The electrical properties of the R.F. types are such that, apart from heater ratings, they are in fact almost identical. It has not however been found possible to achieve this in the case of the output amplifier valve UBL 21 as sufficient output must already be obtained at an anode voltage of only 100 V.

Another feature of these valves is that the resistances in the different feeds need not be changed when the receiver is to be used on a different mains voltage; in this case it is only necessary to adapt the heater circuit.

The full range of the U series comprises the following types:

- UBL 21 — Double diode pentode: heater voltage 55 V.
- UCH 21 — Triode heptode: heater voltage 20 V.
- UF 21 — Variable- $\mu$  pentode: heater voltage 12.6 V.
- UY 21 — Half wave rectifier: heater voltage 50 V.

In the introduction, the chapter entitled — Philips “Miniwatt” key valves — mention has already been made on p. 9 of a number of alternatives for the design of AC/DC receivers; in the following pages the electrical data will first be reviewed.

# UBL 21 Double diode output pentode

The UBL 21, designed for use in AC/DC receivers and taking a heater current of 100 mA, comprises a double diode and a very sensitive 11 Watt output pentode. The diode and pentode sections employ a common cathode and the two diode anodes are both situated at the same height, at the lower end and opposite to the flat sides of the cathode; the pentode part of the valve is located at the upper end of the cathode. As the control grid of the pentode is connected through the base of the valve, this connection has been screened from the leads of the diodes and from the diodes themselves. This combination of pentode and two diodes places the receiver designer in a position to develop a large variety of receiver types, using only a limited number of valve types. The A.F. signal coming from the detection diode is frequently taken first to the grid of an A.F. amplifier before it is passed to the grid of the output pentode, but in this case it is essential for the detector diode to be sufficiently free from ripple to permit of adequate A.F. gain. In the design of the UBL 21 special precautions have had to be taken to ensure that the heater voltage, at the relatively low current consumption of 100

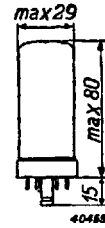

Fig. 1  
Dimensions in mm.

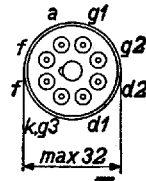
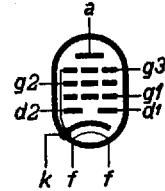

Fig. 2  
Arrangement and sequence of connections.

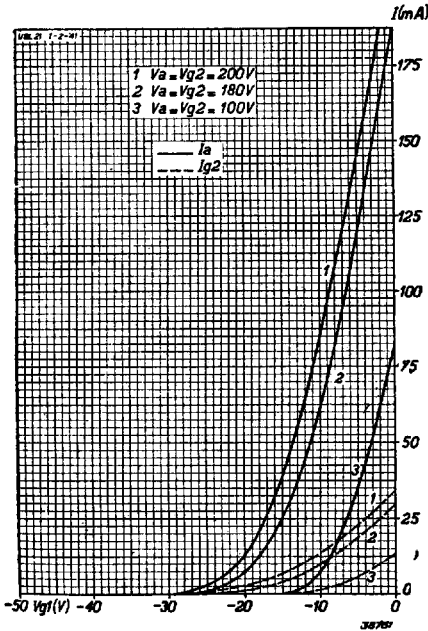

Fig. 3  
Anode and screen current as a function of grid bias at  $V_a = V_{g_2} = 200$  V, 180 V and 100 V.

mA, would not be too high, and the heater power has therefore been kept as low as possible, whilst careful adjustment of the valve system (see below) has made it possible to limit this power to 5.5 W, that is a heater voltage of 55V. For the pentode section the available choice lay between the principle of the output pentode

CL 4 in the AC/DC 200 mA series and that of the CL 6. In the first instance this would mean a screen voltage of 200 V, or the same for both anode and screen when operated on 200 V feed, i.e. screen grid fed direct from the source of anode voltage. Against this there is the fact that on low working voltages, for example 100 V, the output power is on the low side (about 0.8 W), whilst on the other hand, if the principle of the CL 6 were adopted, namely a valve with a low screen voltage (125 V), the output power on low working voltages would be considerably

higher (about 2 W at 100 V). In that case it is necessary to feed the screen from a resistance or potentiometer when operating on 200 V feed. The UBL 21, however, is based on a compromise, the output power being 1.35 W on a working voltage of 100 V.

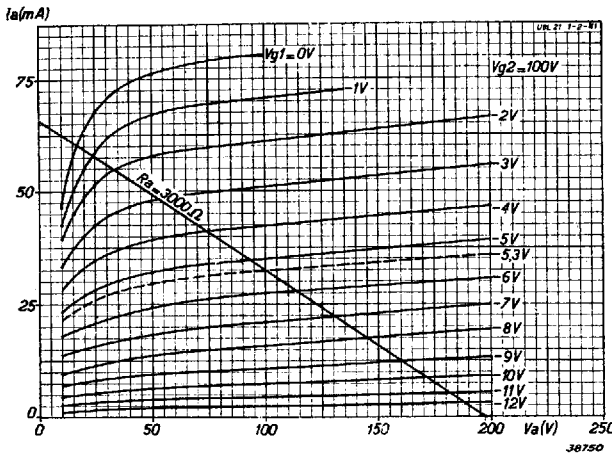

Fig. 4  
Anode current as a function of anode voltage at  $V_{g2} = 100$  V, with  $V_{g1}$  as parameter. The load line in respect of  $R_a = 3000$  Ohms is also included in the diagram.

Owing, moreover, to the greater grid space and robust construction of this valve, at a working voltage of 200 V and 11 W anode dissipation it will deliver a power of not less than 4.8 W with 10 % distortion.

With an output valve to be employed in AC/DC receivers it is of practical importance that any change-over from one working voltage to another should be carried out in the simplest possible manner. In the case of the CL 4 it is not necessary to change cathode and anode resistances when transferring from 200 to 100 V mains, and the switch-over is consequently a very simple operation. When the CL 6 is used, the screen feed resistance of 27,000 Ohms, suitable for 200 V mains, has however to be short-circuited when the set is operated on 100 V, and the anode loading resistance reduced from 6000 to 2000 Ohms. The cathode resistance need not be changed. The higher power supplied by the CL 6 on 100 V is obtainable at the cost of the power on 200 V (2.6 W), besides necessitating much more complicated modification when transferred from one mains voltage to another.

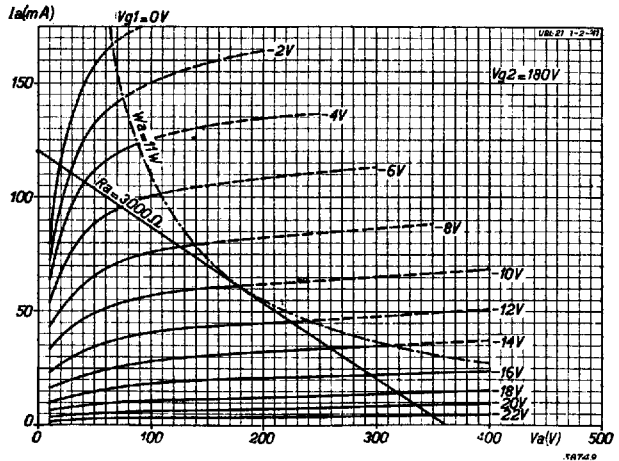

Fig. 5  
Anode current as a function of anode voltage at  $V_{g2} = 180$  V, with  $V_{g1}$  as parameter. The load line for  $R_a = 3000$  Ohms is also shown.

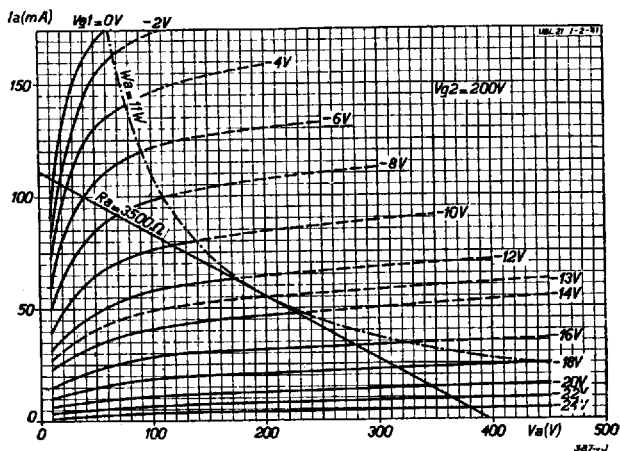

Fig. 6  
Anode current as function of anode voltage at  $V_{g2} = 200$  V, with  $V_{g1}$  as parameter. The load line for  $R_a = 3,500$  Ohms is also given.

Since the UBL 21 can handle an anode dissipation of 11 W, it enables the set to be changed from one voltage to another without modification of the circuit, the output power being quite sufficient on 100 V mains. Two sets of operating data are given for this valve, at a fixed cathode resistance of 140 Ohms; one of these refers to a working voltage of 100 V and the other to 180 V, with a view to operation on 127 and 220 V respectively. (At a mains voltage of 127 V a voltage of 105 V is usually available for the output valve. Deducting the grid bias of 5.3 V, about 100 V remains for the anode voltage. On 220 V mains the feed voltage will be 190 V which, allowing for a drop of 10 V across the cathode resistance for the bias, corresponds to an anode voltage of about 180 V.)

At 180 V a cathode resistance of 140 Ohms just produces the maximum anode dissipation of 11 W (at a voltage of 100 V the same cathode resistance may be retained). The external anode resistance may be the same in both cases and the UBL 21 is therefore suitable for either 110/127 or 220 V mains without modification of the circuit.

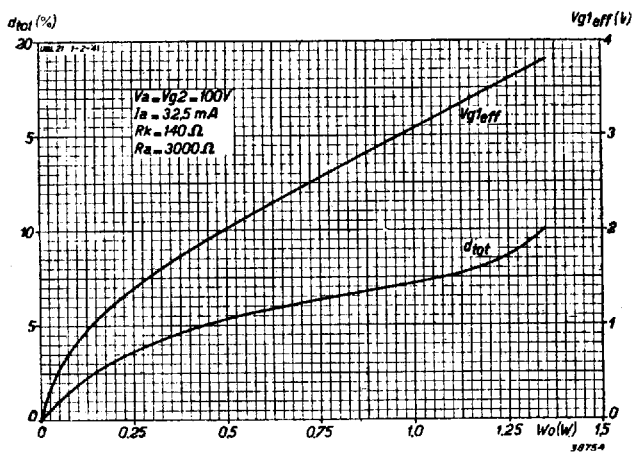

Fig. 7  
Total distortion and required alternating grid voltage as a function of output power at  $V_a = V_{g2} = 100$  V and  $R_a = 3,000$  Ohms.

# UBL 21

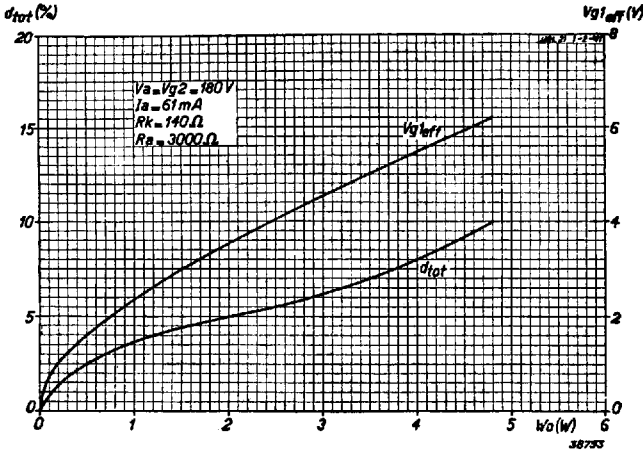

Fig. 8  
 Total distortion and required alternating grid voltage as a function of output power at  $V_a = V_{g2} = 180\text{ V}$  and  $R_a = 3,000\text{ Ohms}$ .

Every care has been bestowed on the diode portion of the valve to ensure that ripple voltages occurring at the diodes shall be as low as possible. The design of the UBL 21 was based on the condition that a gain factor of 60 between the detector diode and the grid of the output pentode<sup>1)</sup> should be obtainable. In order to guarantee this very low ripple level at the detector diode, the heater voltage, in the first place, has been kept as low as possible (see above), whilst, secondly, effective screening is provided. The arrangement of the valve contacts also contributes in this direction, being such that the pilot pin screens the diode  $d_a$ , intended for detection, from the heater pins. Summarising, the UBL 21 offers the following advantages:

<sup>1)</sup> This figure is intended for guidance only; a higher factor may be obtained if the conditions imposed on the ripple are not so stringent.

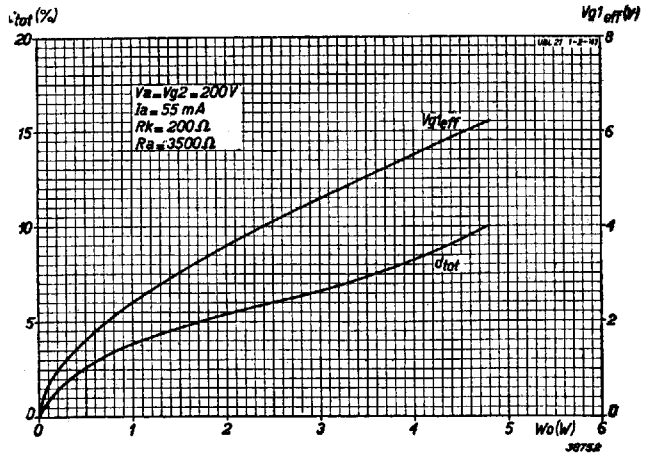

Fig. 9  
 Total distortion and required alternating grid voltage as a function of output power, at  $V_a = V_{g2} = 200\text{ V}$  and  $R_a = 3,500\text{ Ohms}$ .

## ADVANTAGES OF THE UBL 21

- 1) It provides adequate output power when the receiver is operated on a low mains voltage.
- 2) It is possible to run this valve at an anode dissipation of 11 W, thus giving very high output power on a higher mains voltage.
- 3) When changing from low voltage to high voltage mains, none of the resistances in the circuit, including the anode load resistance, need be altered.
- 4) Ripple voltage at the detector diode is very low, enabling a gain factor of 60 to be obtained between that electrode and the grid of the pentode.
- 5) The heater power and consequently the heater voltage also are relatively low.
- 6) The construction is very dependable and steps have been taken in the design to eliminate thermal emission from the grid.
- 7) The mutual conductance of the pentode section is high.
- 8) The combination of diodes with output pentode greatly reduces the number of valve types in the series, whilst still permitting of the design of any type of receiver.

## HEATER RATINGS

Heating: indirect, AC or DC, series connection.

Heater voltage . . . . .  $V_f = 55 \text{ V}$   
 Heater current . . . . .  $I_f = 0.100 \text{ A}$

## CAPACITANCES

a) Pentode section	$C_{ag1}$	< 1.2 pF
b) Diode section	$C_{d1k}$	= 1.8 pF
	$C_{d2k}$	= 2.0 pF
	$C_{d1d2}$	< 0.15 pF
c) Between diode and pentode	$C_{d1a}$	< 0.06 pF
	$C_{d2a}$	< 0.02 pF
	$C_{d1g1}$	< 0.1 pF
	$C_{d2g1}$	< 0.05 pF

## OPERATING DATA: pentode section employed as single output valve.

Anode voltage . . . . .	$V_a$	= 100 V	180 V	200 V
Screen grid voltage . . . . .	$V_{g2}$	= 100 V	180 V	200 V
Cathode resistance . . . . .	$R_k$	= 140 Ohms	140 Ohms	200 Ohms
Grid bias . . . . .	$V_{g1}$	= -5.3 V	-10 V	-13 V
Anode current . . . . .	$I_a$	= 32.5 mA	61 mA	55 mA
Screen grid current . . . . .	$I_{g2}$	= 5.5 mA	10 mA	9.5 mA
Mutual conductance . . . . .	$S$	= 7.5 mA/V	9 mA/V	8 mA/V
Internal resistance . . . . .	$R_i$	= 25,000 Ohms	22,000 Ohms	25,000 Ohms
Recommended anode load . . . . .	$R_a$	= 3000 Ohms	3000 Ohms	3500 Ohms
Output power . . . . .	$W_o$	= 1.35 W	4.8 W	4.8 W
Total distortion . . . . .	$d_{tot}$	= 10 %	10 %	10 %
Required alternating grid voltage at max. modulation . . . . .	$V_{g1eff}$	= 3.8 V	6.2 V	6.2 V
Sensitivity ( $W_o = 50 \text{ mW}$ ). . . . .	$V_{g1eff}$	= 0.55 V	0.5 V	0.5 V

**MAXIMUM RATINGS for the pentode section**

Anode voltage in cold condition . . . . .	$V_{a0}$	= max. 550 V
Anode voltage . . . . .	$V_a$	= max. 250 V
Anode dissipation . . . . .	$W_a$	= max. 11 W
Screen grid voltage in cold condition . . . . .	$V_{g20}$	= max. 550 V
Screen grid voltage . . . . .	$V_{g2}$	= max. 250 V
Screen grid dissipation, valve not modulated ( $V_{g1eff} = 0$ ) . . . . .	$W_{g2}$	= max. 1.9 W
Screen grid dissipation at max. modulation ( $W_o = \text{max.}$ ) . . . . .	$W_{g2}$	= max. 3.5 W
Cathode current. . . . .	$I_k$	= max. 75 mA
Grid current commences at ( $I_{g1} = + 0.3 \mu\text{A}$ ) . . . . .	$V_{g1}$	= max. -1.3 V
Max. external resistance between grid 1 and cathode. . . . .	$R_{g1k}$	= max. 1 M Ohm
Max. external resistance between heater and cathode. . . . .	$R_{fk}$	= max. 20,000 Ohms
Max. voltage between heater and cathode (D.C. voltage or effective value of the A.C. voltage) . . . . .	$V_{fk}$	= max. 150 V

**MAXIMUM RATINGS for the diode section**

Peak voltage, diode 1 . . . . .	$V_{d1}$	= max. 200 V
Peak voltage, diode 2 . . . . .	$V_{d2}$	= max. 200 V
Max. direct current through resistor of diode 1 . . . . .	$I_{d1}$	= max. 0.8 mA
Max. direct current through resistor of diode 2 . . . . .	$I_{d2}$	= max. 0.8 mA
Diode current commences at ( $I_{d1} = + 0.3 \mu\text{A}$ ) . . . . .	$V_{d1}$	= max. -1.3 V
Diode current commences at ( $I_{d2} = + 0.3 \mu\text{A}$ ) . . . . .	$V_{d2}$	= max. -1.3 V

**WORKING PRECAUTION**

The same precautions must be taken with this valve as with the EBL 21 discussed on p.14. The lower heater pin shown in the base in Fig. 2 should be earthed, if possible, or at any rate connected to the point of lowest potential relative to chassis.



# UCH 21 Triode-heptode

This is an AC/DC triode heptode consuming 100 mA heater current, which can be employed as variable- $\mu$  frequency changer. It is also suitable for use as a combined I.F. and A.F. amplifier and as A.F. amplifier and phase inverter for driving push-pull output stages without transformer. Except for the heater ratings, the UCH 21 is identical with the ECH 21 in the A.C. series of valves, to which reference may be made for further description.

In this connection it should be added that in comparison with other frequency changers this valve has very excellent properties on low working voltages. On a voltage of 100 V the conversion conductance is  $580 \mu\text{A/V}$ , whilst, due to the provision of a suppressor grid, the internal resistance is very high (1 MOhm).

It is moreover an extremely simple matter, when using this valve as frequency changer, to transfer the set from 100 V to 200 V operation. The screen feed and cathode resistances need not be changed and the anode resistance of the triode may also be retained. In other words, the circuit of the receiver section needs no modification whatsoever when a change-over is made. Owing to the high mutual conductance, oscillation of the triode is fully reliable, even on low working voltages, making this section of the valve very satisfactory for short-wave work.

The grid of the triode and third grid of the heptode sections are not inter-connected and the two systems can therefore be employed for different purposes; the heptode can for example function as I.F. amplifier with the triode as resistance-capacitance coupled A.F. amplifier, in which case, again, no modification of the circuit is necessary when changing from low voltage to high voltage mains, except that the grid bias of both triode and heptode should be  $-2 \text{ V}$  instead of  $-1 \text{ V}$ . This modification usually takes place automatically in the receiver, since the total current consumed by the output valve UBL 21, as well as that of the UCH 21 used as frequency changer, is doubled when operated on 200 V instead of 100 V, so that the voltage drop across the resistance in the negative feed line from which the grid bias is derived is also roughly doubled.

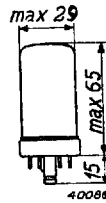

Fig. 1  
Dimensions in mm.

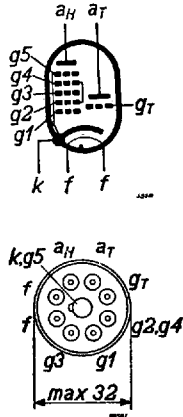

Fig. 2  
Arrangement and sequence of connections.

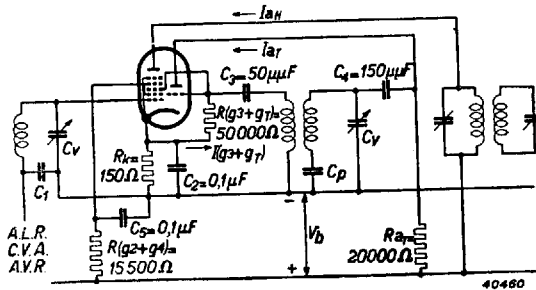

Fig. 3  
Circuit diagram showing the UCH 21 employed as frequency changer.

**HEATER RATINGS**

Heating: indirect, AC or DC, series supply.

Heater voltage . . . . .  $V_f = 20 \text{ V}$   
 Heater current . . . . .  $I_f = 0.100 \text{ A}$

**CAPACITANCES**

a) Heptode section:

$C_{g1} = 6.5 \text{ pF}$	$C_{g1g3} < 0.3 \text{ pF}$
$C_a = 8 \text{ pF}$	$C_{g3} = 8 \text{ pF}$
$C_{ag1} < 0.002 \text{ pF}$	$C_{g1f} < 0.007 \text{ pF}$

b) Triode section:

$C_g = 3.8 \text{ pF}$	$C_{ak} = 1.6 \text{ pF}$
$C_a = 3.1 \text{ pF}$	$C_{ag} = 1.1 \text{ pF}$
$C_{gk} = 2.7 \text{ pF}$	$C_{gf} < 0.1 \text{ pF}$

c) Between heptode and triode, and both combined:

$C_{gTg1H} < 0.1 \text{ pF}$	$C_{(gT+g3)g1H} < 0.35 \text{ pF}$
$C_{(gT+g3)} = 12.3 \text{ pF}$	$C_{(gT+g3)aH} < 0.1 \text{ pF}$

**OPERATING DATA: Heptode section employed as frequency changer (third grid connected to triode grid)**

*200 V and 100 V operation, with sliding screen voltage.*

Anode and supply voltage	$V_a = V_b =$	200 V	100 V
Screen grid resistance . .	$R_{(g2+g4)} =$	15,500 Ohms	15,500 Ohms
Cathode resistance . . .	$R_k =$	150 Ohms	150 Ohms
Grid leak, 3rd grid and triode grid . . . . .	$R_{(g3+gT)} =$	50,000 Ohms	50,000 Ohms
Third grid and triode grid current . . . . .	$I_{(g3+gT)} =$	190 $\mu\text{A}$	95 $\mu\text{A}$
Grid bias . . . . .	$V_{g1} =$	$-2 \text{ V}^1)$ $-28 \text{ V}^2)$	$-1 \text{ V}^1)$ $-14 \text{ V}^2)$
Screen grid voltage . . .	$V_{(g2+g4)} =$	100 V 200 V	53 V 100 V
Anode current . . . . .	$I_a =$	3.5 mA —	1.5 mA —
Screen grid current . . .	$I_{(g2+g4)} =$	6.5 mA —	3 mA —
Conversion conductance .	$S_c =$	750 $\mu\text{A/V}$ 7.5 $\mu\text{A/V}$	580 $\mu\text{A/V}$ 5.8 $\mu\text{A/V}$
Internal resistance . . .	$R_i =$	1 MOhm $>10$	1 MOhm $>10 \text{ MOhm}$
Equivalent noise resistance	$R_{aeq} =$	55,000 —	40,000 — Ohms

<sup>1)</sup> Valve not controlled.  
<sup>2)</sup> Conversion conductance controlled to 1/100.

**OPERATING DATA: Heptode section employed as I.F. amplifier (third grid not connected to triode grid)**

200 V and 100 V operation, with sliding screen voltage.

Anode and supply voltage						
$V_a = V_b =$		200 V		100 V		
Voltage, third grid						
$V_{g3} =$		0 V		0 V		
Screen grid resistance						
$R_{(g2+g4)} =$		30,000 Ohms		30,000 Ohms		
Grid bias						
$V_{g1} =$	$-2 V^1)$	$-28 V^2)$	$-36 V^3)$	$-1 V^1)$	$-15 V^2)$	$-20 V^3)$
Screen grid voltage						
$V_{(g2+g4)} =$	94 V	—	200 V	50 V	—	98 V
Anode current						
$I_a =$	5.2 mA	—	—	2.6 mA	—	—
Screen current						
$I_{(g2+g4)} =$	3.5 mA	—	—	1.9 mA	—	—
Mutual conductance						
$S =$	2200 $\mu A/V$	22 $\mu A/V$	2.2 $\mu A/V$	2000 $\mu A/V$	20 $\mu A/V$	2.0 $\mu A/V$
Internal resistance						
$R_i =$	0.7	>10	>10	0.7	>10	>10 M Ohms
Gain factor from screen						
$\mu_{g2g1} =$	19	—	—	19	—	—
Equivalent noise resistance						
$R_{aeq} =$	9000	—	—	4900	—	— Ohms

<sup>1)</sup> Valve not controlled.

<sup>2)</sup> Mutual conductance controlled to 1/100.

<sup>3)</sup> Mutual conductance controlled to 1/1000 (extreme limit of control).

**STATIC DATA: TRIODE SECTION**

Anode voltage . . . . .	$V_a =$	100 V
Grid bias . . . . .	$V_g =$	0 V
Anode current . . . . .	$I_a =$	12 mA
Mutual conductance . . . . .	$S =$	3.2 mA/V
Gain factor . . . . .	$\mu =$	19

**OPERATING DATA: TRIODE SECTION employed as oscillator valve (third grid of heptode connected to triode grid)**

Supply voltage . . . . .	$V_b =$	100 V	200 V
Anode series resistance . . . . .	$R_a =$	20,000 Ohms	20,000 Ohms
Grid leak . . . . .	$R_{(g3+gT)} =$	50,000 Ohms	50,000 Ohms
Current through grid leak to be adjusted to	$I_{(g3+gT)} =$	95 $\mu A$	190 $\mu A$
Anode current . . . . .	$I_a =$	1.9 mA	4.1 mA
Effective mutual conductance . . . . .	$S_{eff} =$	0.44 mA/V	0.45 mA/V

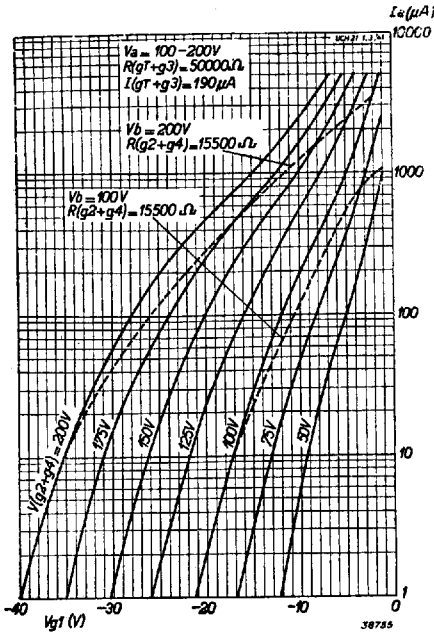

Fig 4

Anode current of the heptode section of the UCH 21 employed as frequency changer, as a function of grid bias, with screen grid voltage as parameter, at an anode voltage of 100—200 V. Broken lines: screen fed through a resistance of 15,500 Ohms.

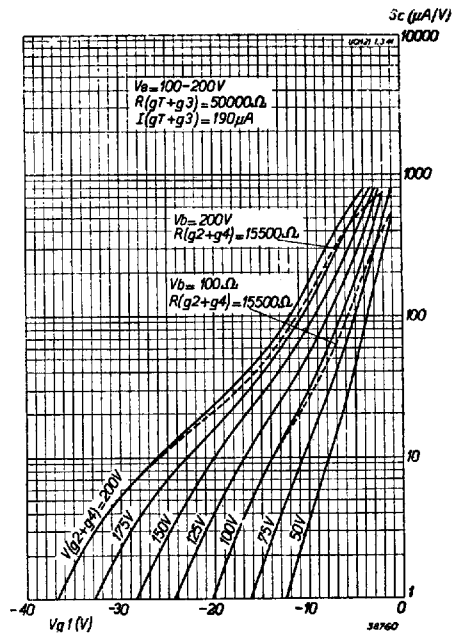

Fig 5

Conversion conductance  $S_c$  as a function of grid bias  $V_{g1}$ , at an anode voltage of 100—200 V, with screen grid voltage as parameter. Broken lines: screen fed through a resistance of 15,500 Ohms.

**OPERATING DATA: TRIODE SECTION employed as A.F. amplifier, resistance-capacitance coupled (third grid not connected to triode grid)**

Supply voltage	Anode resistance	Grid bias	Anode current	Alternating output voltage	Total distortion	Voltage gain
$V_b$ (V)	$R_a$ (Mohms)	$V_g$ (V)	$I_a$ (mA)	$V_{oeff}$ (V)	$d_{tot}$ (%).	$\frac{V_{oeff}}{V_{g1eff}}$
200	0.2	-2	0.8	7.5	2.8	10
100	0.2	-1	0.37	7.5	6	10
200	0.1	-2	1.5	7.5	2.8	10.5
100	0.1	-1	0.68	7.5	5.8	10.5
200	0.05	-2	2.8	7.5	2.2	11
100	0.05	-1	1.3	7.5	5.4	11

**OPERATING DATA FOR THE UCH 21 employed as phase inverter for the modulation of a push-pull output stage (third grid not connected to triode grid)**

(With feedback, see Fig. 6)

Supply voltage . . .	$V_b$	=	200 V	100 V
Anode resistance (heptode) . . . . .	$R_{aH}$	=	0.2 MOhm	0.1 MOhm
Anode resistance (triode) . . . . .	$R_{aT}$	=	0.2 MOhm	0.1 MOhm
Screen grid resistance	$R_{(g_2+g_4)}$	=	0.1 MOhm	0.1 MOhm
Cathode resistance . .	$R_k$	=	0.1 MOhm	0.18 MOhm
Combined anode current, triode and heptode . . . . .	$I_{(aH+aT)}$	=	700 Ohms	500 Ohms
Screen grid current . .	$I_{(g_2+g_4)}$	=	2.1 mA	2.7 mA
Alternating input voltage to give an output of 10 $V_{eff}$ . . .	$V_{g1eff}$	=	1.1 mA	1.3 mA
Voltage gain . . . . .	$V_{oeff}/V_{g1eff}$	=	0.4	0.65 mA
Totale distortion . . .	$d_{tot}$	=	0.13 V	0.14 V
		=	75	70
		=	2.5 %	2.3 %
		=	3.1 %	2.4 %

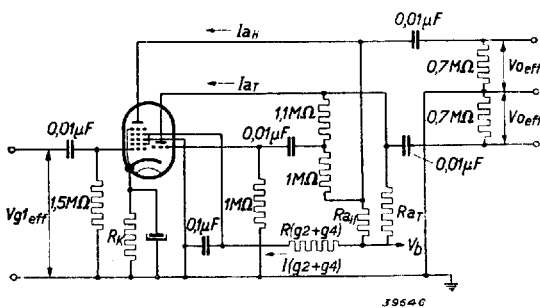

**Fig. 6**  
Circuit diagram showing the UCH 21 employed as A.F. amplifier and phase inverter with feedback, for a push-pull output stage.

**MAXIMUM RATINGS FOR THE HEPTODE SECTION**

Anode voltage, in cold condition . . . . .	$V_{ao}$	= max. 550 V
Anode voltage . . . . .	$V_a$	= max. 250 V
Anode dissipation . . . . .	$W_a$	= max. 1.5 W
Screen grid voltage, in cold condition . . . . .	$V_{(g2+g4)o}$	= max. 550 V
Screen grid voltage, valve not controlled ( $I_a = 3$ mA) . . . . .	$V_{(g2+g4)}$	= max. 100 V
Screen grid voltage, valve controlled ( $I_a < 1$ mA)	$V_{(g2+g4)}$	= max. 250 V
Screen grid dissipation . . . . .	$W_{(g2+g4)}$	= max. 1 W
Cathode current . . . . .	$I_k$	= max. 15 mA
Grid current commences at ( $I_{g1} = +0.3 \mu A$ ) . . . . .	$V_{g1}$	= max. -1.3 V
Grid current commences at ( $I_{g3} = +0.3 \mu A$ ) . . . . .	$V_{g3}$	= max. -1.3 V
Max. external resistance between grid 1 and cathode . . . . .	$R_{g1k}$	= max. 3 MOhms
Max. external resistance between grid 3 and cathode . . . . .	$R_{g3k}$	= max. 3 MOhms
Max. external resistance between heater and cathode . . . . .	$R_{fk}$	= max. 20,000 Ohms
Max. voltage between heater and cathode (D.C. voltage or eff. value of the alternating voltage)	$V_{fk}$	= max. 150 V

**MAXIMUM RATINGS FOR THE TRIODE SECTION**

Anode voltage, in cold condition . . . . .	$V_{ao}$	= max. 550 V
Anode voltage . . . . .	$V_a$	= max. 175 V
Anode dissipation . . . . .	$W_a$	= max. 0.5 W
Grid current commences at ( $I_g = +0.3 \mu A$ ) . . . . .	$V_g$	= max. -1.3 V
Max. external resistance in grid circuit . . . . .	$R_{gk}$	= max. 3 M Ohms

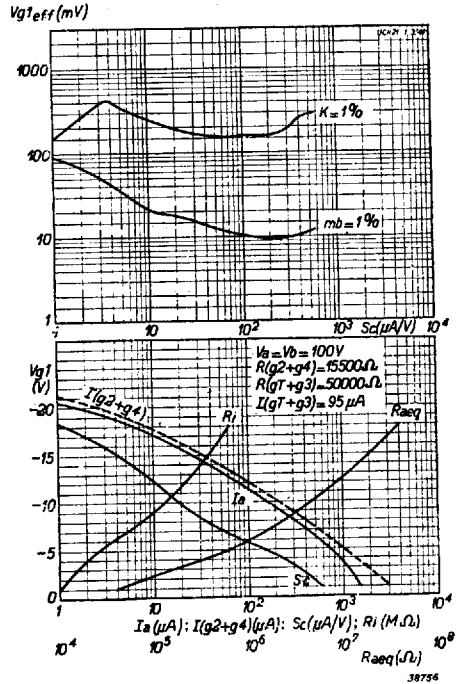

Fig. 7

At an anode or working voltage of 100 V, with screen fed through a resistance of 15,500 Ohms. *Upper diagram:* Highest permissible effective value of R.F. alternating voltage with 1% cross modulation ( $K = 1\%$ ) and with 1% modulation hum ( $mb = 1\%$ ), both in respect of the interfering signal at the grid, as a function of conversion conductance.

*Lower diagram:* Anode current  $I_a$ , screen current  $I_{(g_2 + g_4)}$ , conversion conductance  $S_c$ , internal resistance  $R_i$ , and equivalent noise resistance  $R_{aeq}$  as a function of grid bias  $V_{g1}$ .

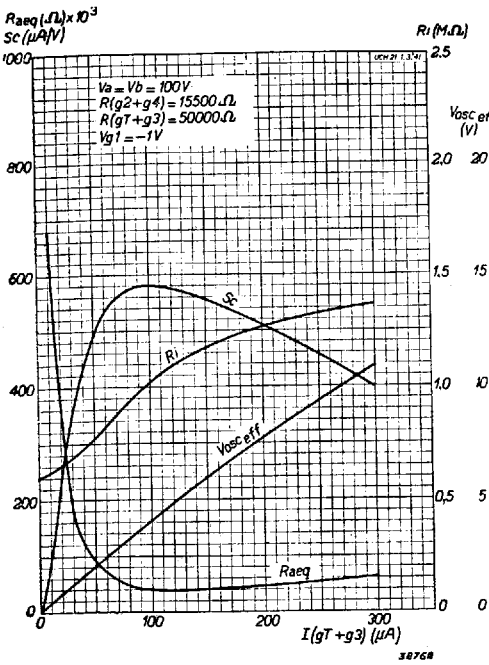

Fig. 8

Conversion conductance  $Sc$ , internal resistance  $Ri$ , effective A.C. oscillator voltage  $Vosc$  and equivalent noise resistance  $Raeq$  as a function of oscillator grid current  $I(gT + g_3)$ , at  $V_a = V_b = 100$  V and  $R(g_2 + g_4) = 15,500$  Ohms.

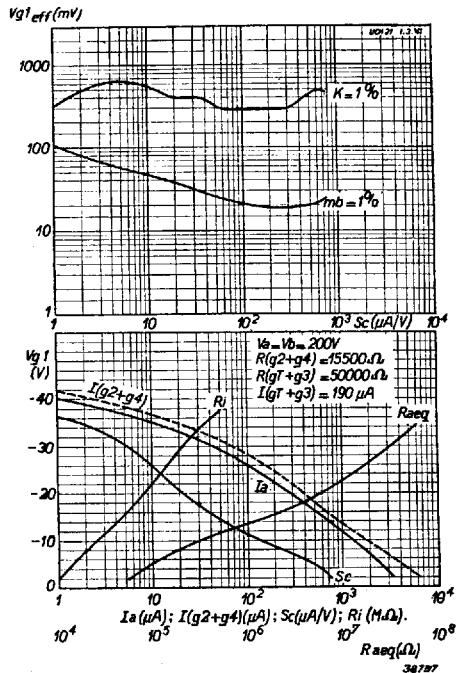

Fig. 9

At an anode and feed voltage of 200 V and with screen grid fed through a resistance of 15,500 Ohms: *Upper diagram*; Highest permissible effective value of R.F. alternating voltage with 1% cross modulation ( $K = 1\%$ ) and with 1% modulation hum ( $mb = 1\%$ ), both in respect of the interfering signal at the grid, as a function of conversion conductance. *Lower diagram*; Anode current  $I_a$ , screen grid current  $I(g_2 + g_4)$ , conversion conductance  $Sc$ , internal resistance  $Ri$  and equivalent noise resistance  $Raeq$  as a function of grid bias  $V_{g1}$ .

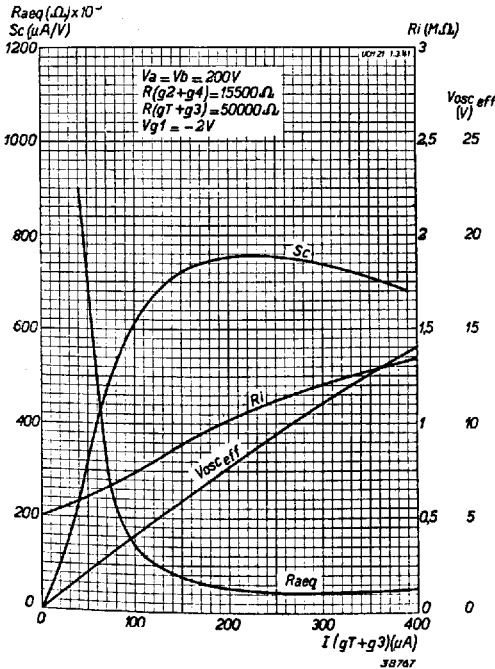

Fig. 10

Conversion conductance  $Sc$ , internal resistance  $Ri$ , effective A.C. oscillator voltage  $Vosc$  and equivalent noise resistance  $Raeq$  as a function of oscillator grid current  $I(gT + g_3)$ , with  $V_a = V_b = 200$  V and  $R(g_2 + g_4) = 15,500$  Ohms.

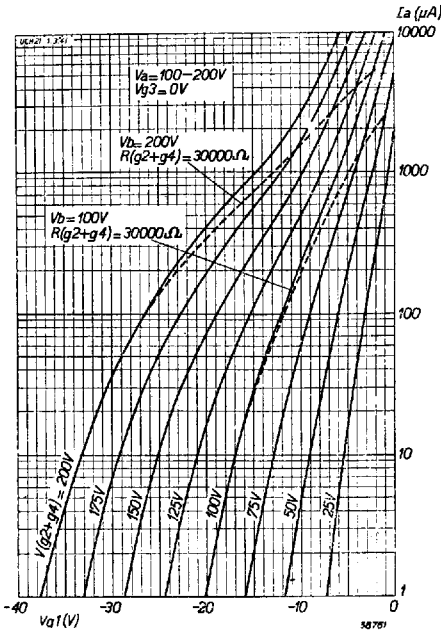

Fig. 11

Anode current as a function of grid bias at  $V_a = 100-200$  V and  $V_{g_3} = 0$  V, with screen grid voltage as parameter: valve employed as I.F. amplifier (heptode). Broken lines: screen fed through a resistance of 30,000 Ohms.

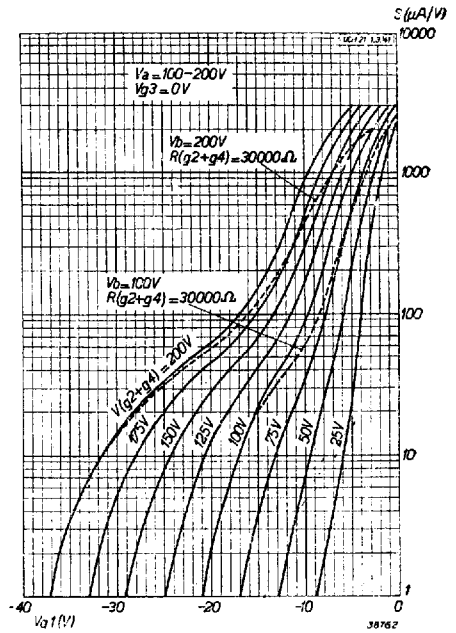

Fig. 12

Mutual conductance of the heptode section as a function of grid bias at  $V_a = 100-200$  V and  $V_{g_3} = 0$  V with screen voltage as parameter: (valve employed as I.F. amplifier). Broken lines: screen fed through a resistance of 30,000 Ohms.

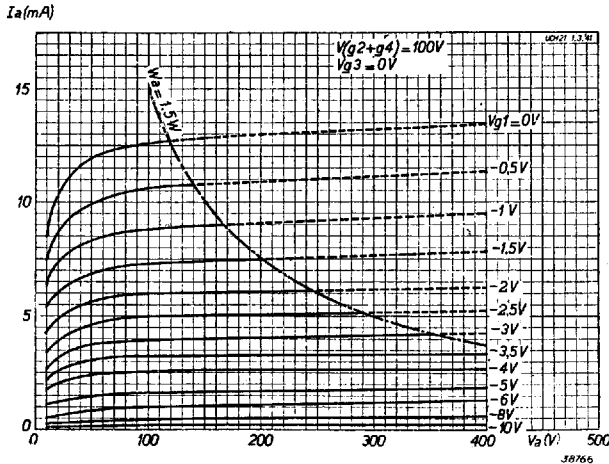

Fig. 13

Anode current as function of anode voltage at  $V_{(g_2+g_4)} = 100$  V and  $V_{g_3} = 0$  V, with grid voltage as parameter.



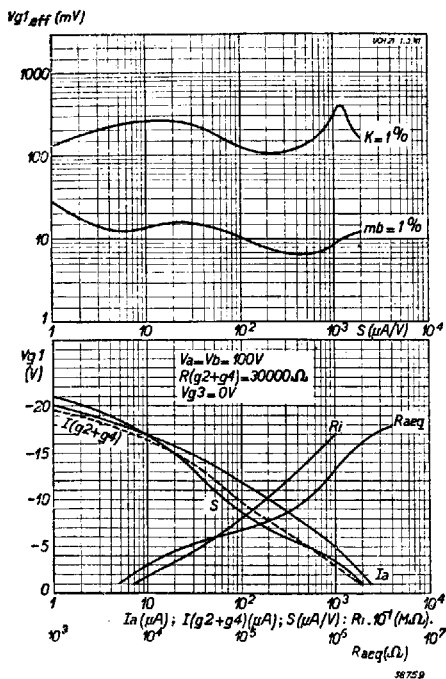

Fig. 14

At  $V_a = V_b = 100$  V and  $V_{g_3} = 0$  V, with screen grid fed through a resistance of 30,000 Ohms: valve employed as I.F. amplifier (heptode).

Upper diagram; maximum permissible effective value of R.F. alternating voltage with 1 % cross modulation ( $K = 1\%$ ), and with 1 % modulation hum ( $mb = 1\%$ ), in each case in respect of interfering signal at the control grid, as a function of mutual conductance.

Lower diagram; Anode current  $I_a$ , screen grid current  $I(g_2 + g_4)$ , mutual conductance  $S$ , internal resistance  $R_i$  and equivalent noise resistance  $R_{aeq}$ , as a function of grid bias  $V_{g_1}$ .

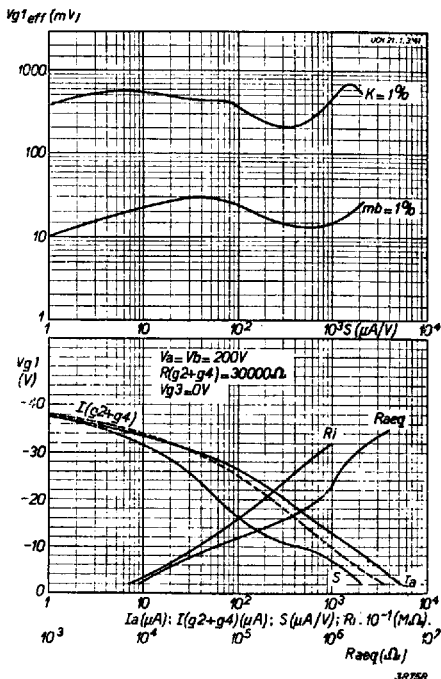

Fig. 15

At  $V_a = V_b = 200$  V,  $V_{g_3} = 0$  V and screen fed through a resistance of 30,000 Ohms; heptode employed as I.F. amplifier.

Upper diagram; Maximum permissible effective value of R.F. alternating voltage with 1 % cross modulation ( $K = 1\%$ ) and with 1 % modulation hum ( $mb = 1\%$ ), in each case in respect of interfering signal at the control grid, as a function of mutual conductance.

Lower diagram; Anode current  $I_a$ , screen grid current  $I(g_2 + g_4)$ , mutual conductance  $S$ , internal resistance  $R_i$  and equivalent noise resistance  $R_{aeq}$  as function of grid bias  $V_{g_1}$ .

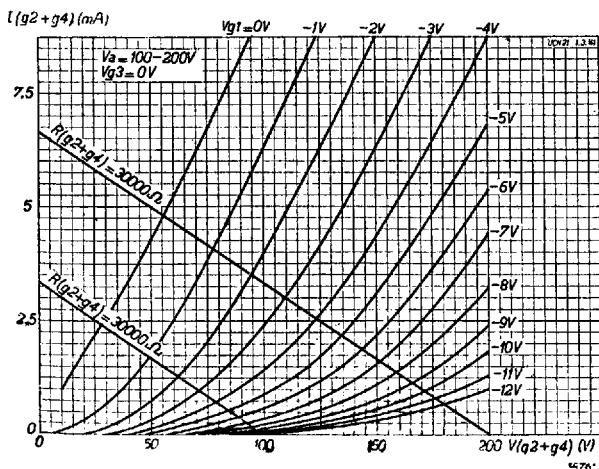

Fig. 16  
Screen grid current as a function of screen voltage at  $V_a = 100-200$  V and  $V_{g_3} = 0$  V, with grid bias as parameter.

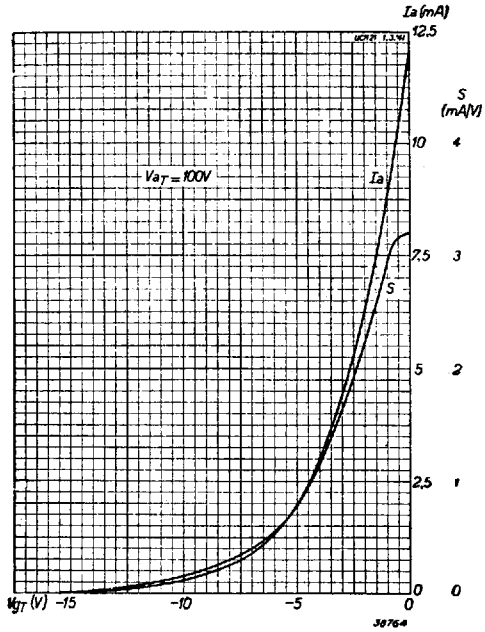

Fig. 17  
Anode current and mutual conductance of the triode as function of grid bias at  $V_{aT} = 100$  V.

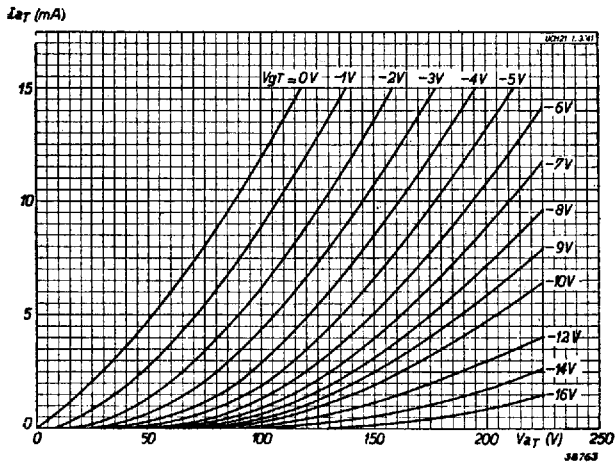

Fig. 18  
Anode current of the triode section as a function of anode voltage, with grid bias as parameter.

# UF 21 Variable MU R.F. pentode

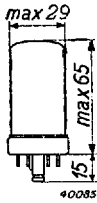

Fig. 1  
Dimensions in mm

The UF 21 is a variable-mu R.F. or I.F. amplifier pentode for AC/DC receivers, consuming a heater current of 100 mA. It can also be employed as an R-C coupled A.F. amplifier, in which case it is also possible to obtain very excellent automatic gain control; since in such cases it is very important to know the amount of distortion occurring at a given output voltage and grid bias, details have been included in the Operating Data.

Apart from the heater ratings, the UF 21 is identical with the EF 22, also as far as the sliding screen voltage is concerned.

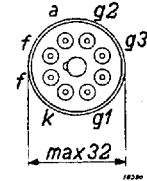
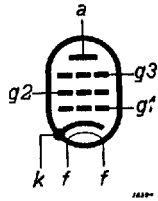

Fig. 2  
Arrangement and sequence of contacts.

## HEATER RATINGS

Heating: indirect, AC or DC, series supply.

Heater voltage . . . . .  $V_f = 12.6$  V

Heater current . . . . .  $I_f = 0.100$  A

## CAPACITANCES

$$C_a = 6.6 \text{ pF}$$

$$C_{g1} = 5.6 \text{ pF}$$

$$C_{ag1} < 0.002 \text{ pF}$$

$$C_{g1f} < 0.006 \text{ pF}$$

## OPERATING DATA: valve employed as R.F. or I.F. amplifier

a) With fixed screen voltage.

Anode voltage

$$V_a = \begin{matrix} 100 \text{ V} & & 200 \text{ V} \end{matrix}$$

Suppressor grid voltage

$$V_{g3} = \begin{matrix} 0 \text{ V} & & 0 \text{ V} \end{matrix}$$

Screen grid voltage

$$V_{g2} = \begin{matrix} 100 \text{ V} & & 100 \text{ V} \end{matrix}$$

Cathode resistance

$$R_k = \begin{matrix} 325 \text{ Ohms} & & 325 \text{ Ohms} \end{matrix}$$

Grid bias

$$V_{g1} = \begin{matrix} -2.5 \text{ V}^1) & -19 \text{ V}^2) & -22 \text{ V}^3) & -2.5 \text{ V}^1) & -19 \text{ V}^2) & -22 \text{ V}^3) \end{matrix}$$

Anode current

$$I_a = \begin{matrix} 6 \text{ mA} & - & - & 6 \text{ mA} & - & - \end{matrix}$$

Screen grid current

$$I_{g2} = \begin{matrix} 1.7 \text{ mA} & - & - & 1.7 \text{ mA} & - & - \end{matrix}$$

Mutual conductance

$$S = \begin{matrix} 2200 & 22 & 7 & 2200 & 22 & 7 \mu\text{A/V} \end{matrix}$$

Internal resistance

$$R_i = \begin{matrix} 0.4 \text{ M}\Omega & > 10 \text{ M}\Omega & > 10 \text{ M}\Omega & 1 \text{ M}\Omega & > 10 \text{ M}\Omega & > 10 \text{ M}\Omega \end{matrix}$$

Gain factor in respect of screen grid

$$\mu_{g2g1} = \begin{matrix} 17 & - & - & 17 & - & - \end{matrix}$$

Equivalent noise resistance

$$R_{aeq} = \begin{matrix} 6200 \text{ Ohms} & - & - & 6200 \text{ Ohms} & - & - \end{matrix}$$

b) With sliding screen voltage.

Anode voltage						
$V_a =$	100 V		200 V			
Suppressor grid voltage						
$V_{g3} =$	0 V		0 V			
Screen grid resistance						
$R_{g2} =$	60,000 Ohms		60,000 Ohms			
Cathode resistance						
$R_k =$	325 Ohms		325 Ohms			
Grid bias						
$V_{g1} =$	$-1.3 V^1)$	$-19 V^2)$	$-23 V^3)$	$-2.5 V^1)$	$-37 V^2)$	$-46 V^3)$
Screen grid voltage						
$V_{g2} =$	50 V	—	100 V	100 V	—	200 V
Anode current						
$I_a =$	3.2 mA	—	—	6 mA	—	—
Screen grid current						
$I_{g2} =$	0.85 mA	—	—	1.7 mA	—	—
Mutual conductance						
$S =$	2000	20	5	2200	22	$4.5 \mu A/V$
Internal resistance						
$R_i =$	$1 M \Omega$	$>10 M \Omega$	$>10 M \Omega$	$1 M \Omega$	$>10 M \Omega$	$>10 M \Omega$
Equivalent noise resistance						
$R_{aeq} =$	$4000 \Omega$	—	—	$6200 \text{ Ohms}$	—	—

- 1) Valve not controlled.
- 2) Mutual conductance controlled to  $1/100$ .
- 3) Extreme limit of control range.

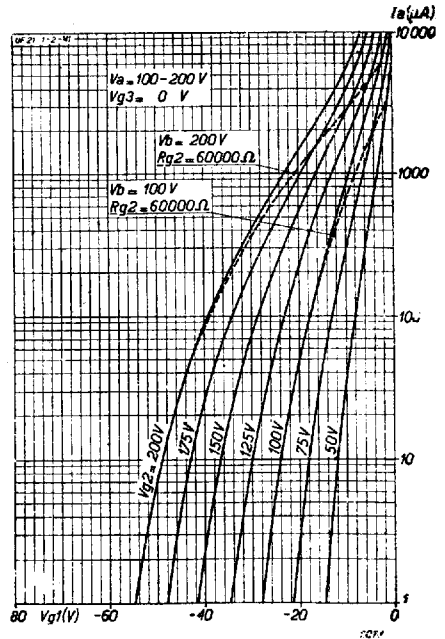

Fig 3  
Anode current as a function of grid bias at  $V_a = 100 - 200 \text{ V}$  and  $V_{g3} = 0 \text{ V}$ , with screen voltage as parameter. The broken lines show the anode current when the valve is controlled, with the screen grid fed through a resistance of 60,000 Ohms from the 200 V or 100 V source.

**OPERATING DATA:** valve employed as resistance-capacitance coupled A.F. amplifier, with gain control applied to the control grid

Anode coupling res. $R_a$ (M Ohm)	Screen grid res. $R_{g_2}$ (M Ohm)	Anode current $I_a$ (mA)	Screen grid current $I_{g_1}$ (mA)	Cathode res. $R_k$ (Ohms)	Control volts on grid 1. $-V_R$ (V)	Gain	Required alternating grid voltage and total distortion to give an alternating output voltage of:					
							$V_{o_{eff}} = 3\text{ V}$		$V_{o_{eff}} = 5\text{ V}$		$V_{o_{eff}} = 8\text{ V}$	
							$\frac{V_{o_{eff}}}{V_{g_1_{eff}}}$	$d_{tot}$ (%)	$\frac{V_{o_{eff}}}{V_{g_1_{eff}}}$	$d_{tot}$ (%)	$\frac{V_{o_{eff}}}{V_{g_1_{eff}}}$	$d_{tot}$ (%)
$V_b = 200\text{ V}$												
0.2	0.8	0.65	0.17	2500	0	88	0.034	0.75	0.057	1.25	0.091	2.0
0.2	0.8	0.54	0.14	2500	5	35	0.086	1.2	0.140	2.0	0.228	3.2
0.2	0.8	0.46	0.11	2500	10	22	0.136	1.4	0.228	2.3	0.364	3.7
0.2	0.8	0.38	0.08	2500	15	15	0.200	1.7	0.334	2.8	0.534	4.5
0.2	0.8	0.31	0.06	2500	20	11	0.272	1.8	0.455	3.0	0.726	4.8
0.2	0.8	0.25	0.05	2500	25	8	0.375	2.3	0.625	3.8	1.0	5.8
$V_b = 100\text{ V}$												
0.1	0.4	1.2	0.35	1300	0	78	0.038	0.75	0.064	1.25	0.102	2.0
0.1	0.4	0.96	0.28	1300	5	33	0.091	1.2	0.152	2.0	0.242	3.2
0.1	0.4	0.78	0.22	1300	10	20	0.150	1.6	0.250	2.65	0.400	4.25
0.1	0.4	0.62	0.16	1300	15	13	0.230	2.0	0.385	3.3	0.615	5.3
0.1	0.4	0.48	0.12	1300	20	8	0.375	2.2	0.625	3.65	1.000	5.85
0.1	0.4	0.36	0.09	1300	25	6	0.500	3.45	0.832	5.65	1.333	9
$V_b = 100\text{ V}$												
0.2	0.8	0.33	0.08	2500	0	82	0.037	0.85				
0.2	0.8	0.26	0.06	2500	2.5	37	0.081	2.3				
0.2	0.8	0.21	0.055	2500	5	21	0.143	3.4				
0.2	0.8	0.18	0.03	2500	7.5	13	0.230	4.1				
0.2	0.8	0.14	0.025	2500	10	9	0.334	4.3				
0.2	0.8	0.12	0.02	2500	12.5	7	0.430	5.1				
0.1	0.4	0.61	0.15	1300	0	72	0.041	0.85				
0.1	0.4	0.47	0.13	1300	2.5	35	0.086	2.3				
0.1	0.4	0.37	0.10	1300	5	20	0.150	3.45				
0.1	0.4	0.29	0.06	1300	7.5	12	0.250	4.3				
0.1	0.4	0.22	0.05	1300	10	7	0.430	5.25				
0.1	0.4	0.17	0.04	1300	12.5	6	0.500	6.2				

**MAXIMUM RATINGS**

- $V_{a0}$  ( $I_a = 0$ ) = max. 550 V
- $V_a$  = max. 250 V
- $W_a$  = max. 2 W
- $V_{g_{20}}$  ( $I_{g_2} = 0$ ) = max. 550 V
- $V_{g_2}$  ( $I_a < 3\text{ mA}$ ) = max. 250 V
- $V_{g_2}$  ( $I_a = 6\text{ mA}$ ) = max. 150 V
- $W_{g_2}$  = max. 0.3 W
- $I_k$  = max. 10 mA
- $V_{g_1}$  ( $I_{g_1} = +0.3\text{ }\mu\text{A}$ ) = max. -1.3 V
- $R_{g_{1k}}$  = max. 3 M Ohms
- $R_{fk}$  = max. 20,000 Ohms
- $V_{fk}$  = max. 150 V

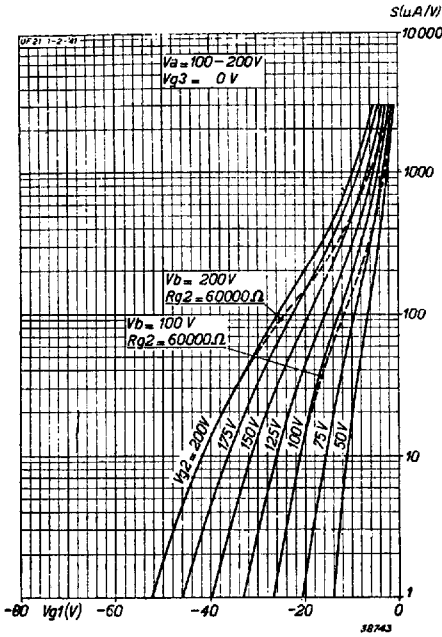

Fig. 4

Mutual conductance as a function of grid bias, with screen grid voltage as parameter. The dotted lines show the conductance with control on the valve and the screen fed through a resistance of 60,000 Ohms from the 100 V or 200 V source.

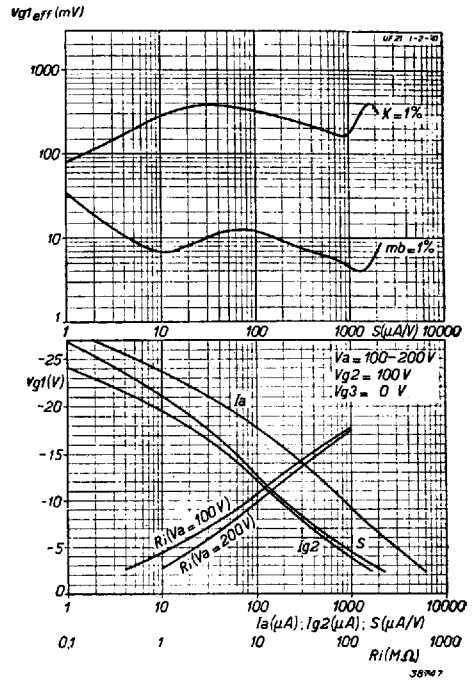

Fig. 5

At  $V_a = 100-200V$ ,  $V_{g2} = 100V$  (fixed screen voltage) and  $V_{g3} = 0V$ . Upper diagram; maximum permissible effective value of alternating grid voltage with 1% cross modulation ( $K = 1\%$ ) and also with 1% modulation hum ( $mb = 1\%$ ), as function of the mutual conductance. Lower diagram; Mutual conductance, anode current, screen grid current and internal resistance as function of grid bias.

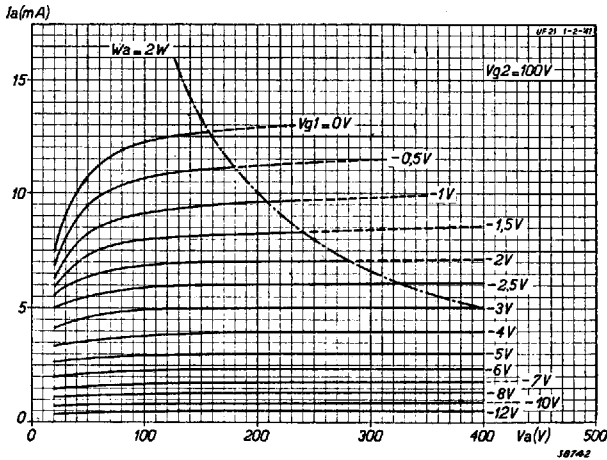

Fig. 6

Anode current as a function of anode voltage at a fixed screen voltage of 100 V, with grid bias as parameter.

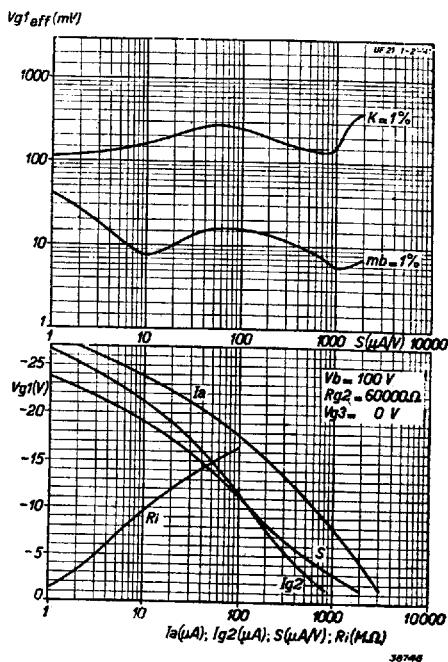
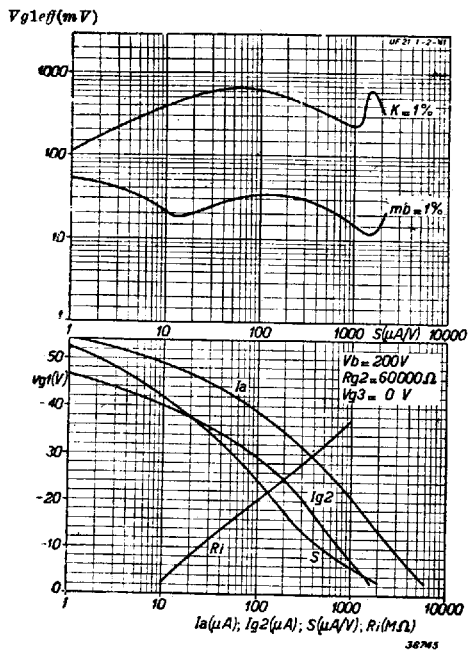

Fig. 7  
At  $V_b = 200V$ ,  $R_{g2} = 60,000$  Ohms (screen fed through a resistance) and  $V_{g3} = 0V$ .  
Upper diagram; maximum permissible effective value of alternating grid voltage with 1% cross modulation ( $K = 1\%$ ) and also 1% modulation hum ( $mb = 1\%$ ), as function of mutual conductance.  
Lower diagram; Mutual conductance, anode current, screen grid current and internal resistance as function of grid bias.

Fig. 8  
At  $V_b = 100V$ ,  $R_{g2} = 60,000$  Ohms (screen fed through a resistance) and  $V_{g3} = 0V$ .  
Upper diagram; maximum permissible effective value of alternating grid voltage with 1% cross modulation ( $K = 1\%$ ) and also with 1% hum modulation ( $mb = 1\%$ ), as function of mutual conductance.  
Lower diagram; Mutual conductance, anode current, screen grid current and internal resistance as function of grid bias.

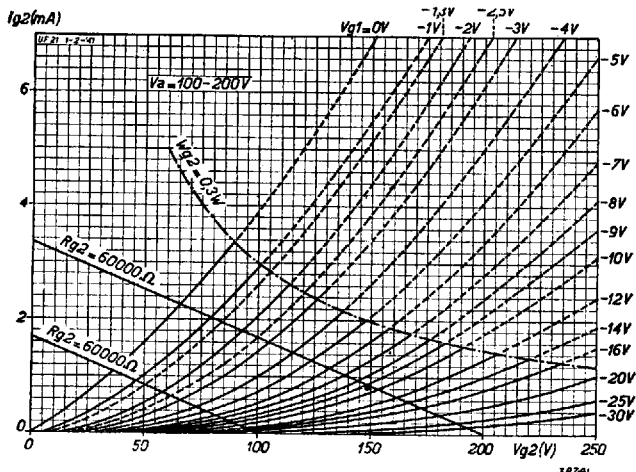

Fig. 9  
Screen grid current as a function of screen voltage, with grid bias as parameter. The curves are a fair approximation in respect of all anode voltages between 100 and 200 V.

# UY 21 Half-wave rectifier valve

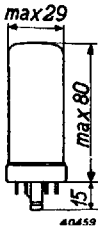

Fig. 1  
Dimensions in mm.

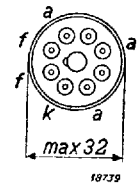

Fig. 2  
Arrangement and  
sequence of con-  
nections.

This is an indirectly-heated high vacuum rectifier for AC/DC operation on 100 mA heater current. Endeavours have been made in the design of this valve to effect a compromise between the highest possible anode current and the lowest practicable heater power. The first of these requirements is connected with the use of a single valve for the power side of receivers with high output (push-pull output stages); the purpose underlying the second stipulation is the connection, in series with the heater of the UY 21, of a larger number of heaters of other valves, at a given mains voltage. The best compromise proved to be a maximum direct current in the anode circuit of 140 mA at a heater voltage of 50 V. On the basis of this current it is possible to feed almost any type of receiver, even when fitted with two UBL 21 output valves in a push-pull circuit.

### HEATER RATINGS

Heating: indirect, AC/DC, series feed.

Heater voltage . . . . .  $V_f = 50 \text{ V}$   
 Heater current . . . . .  $I_f = 0.100 \text{ A}$

### MAXIMUM RATINGS

Alternating anode voltage on the valve . . .  $V_i = \text{max. } 250 \text{ V}_{eff}$   
 Direct current output . . . . .  $I_o = \text{max. } 140 \text{ mA}$   
 Voltage between heater and cathode . . .  $V_{fk} = \text{max. } 550 \text{ V}$   
 Input capacitance of smoothing filter . . .  $C = \text{max. } 60 \mu\text{F}$

On high mains voltages, when high capacitance smoothing condensers are employed, a limiting resistance should be included in the anode circuit, for which resistance a minimum value is indicated in the following table:

Mains voltage	Smoothing condenser	Series resistance
170—250 V	60 $\mu\text{F}$ 32 $\mu\text{F}$ 16 $\mu\text{F}$ 8 $\mu\text{F}$	min. 175 Ohms min. 125 Ohms min. 75 Ohms 0
127—170 V	60 $\mu\text{F}$ 32 $\mu\text{F}$ 16 $\mu\text{F}$	min. 100 Ohms min. 75 Ohms min. 30 Ohms
Maximum 127 V	60 $\mu\text{F}$	0



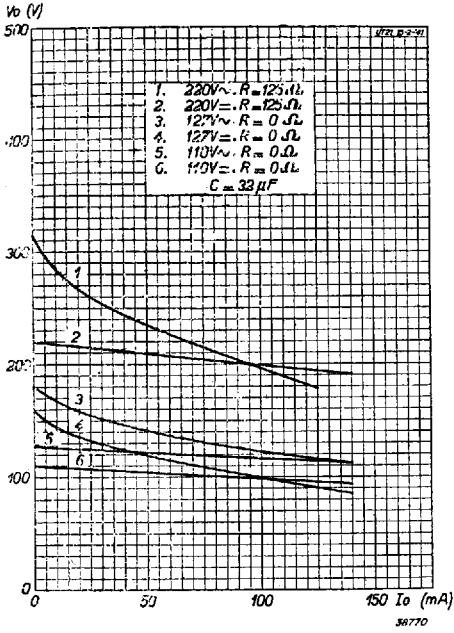

Fig. 3  
Load lines for the UY 21

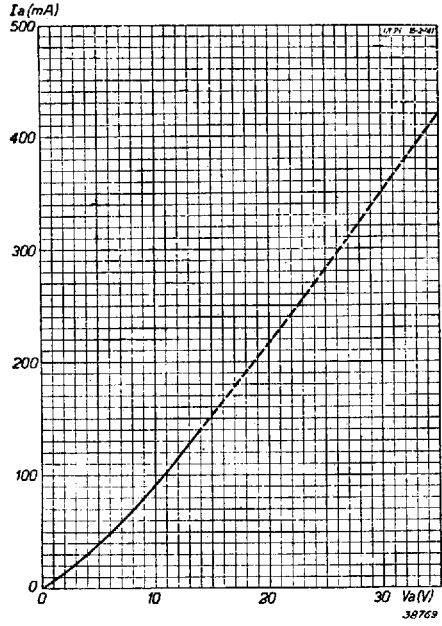

Fig. 4  
Anode current as a function of direct voltage.



# **CIRCUITS**

**of AC and AC/DC receivers based  
on the use of the new “Miniwatt”  
key valves**

## I. Superheterodyne A.C. receiver with three receiving valves

*Valves used:* ECH 21—ECH 21—EBL 21—EM 4—AZ 1.

### *Description*

The performance of a superheterodyne receiver of this type is quite equal to that of any other conventional 4-valve set; using two combination valves ECH 21 it has been possible to design a receiver employing only three valves without in any way detracting from the characteristic features of the set. The advantages of this arrangement are as follows:

High sensitivity, namely 10  $\mu$ V (required for a standard output of 50 mW).

Considerable output power: 4.5 W at 10 % distortion.

Sufficient A.F. gain for gramophone pickup.

Tone control.

Effective automatic gain control.

Tuning indication by means of electronic indicator.

Three wave ranges: 830—2050 m,  
200— 550 m,  
15— 50 m.

### *Coils.*

The different wave ranges are selected by switching the coils, this being preferable to the method, often employed, of short-circuiting parts of the coils, although the latter procedure does not involve so many switch contacts. Short-circuited coil sections are liable to produce different kinds of interference, such as faulty tuning, unwanted coupling etc, but in the circuit under review those coils which are not actually in use are switched out of the circuit altogether and any form of interference is thereby avoided. If any trouble is experienced in connection with whistling tones, these can usually be suppressed by interposing a filter circuit in series between aerial and earth, tuned to 470 kc/s. It is advisable for the short and medium wave aerial circuits to screen all from the oscillator circuit and the former should also be provided with individual switching, necessitating two separate switches.

Data for the R.F. circuits are based on the use of 20—500 pF variable condensers: the zero capacitance on medium and long waves is estimated at 50 and 70 pF respectively (trimmers, wiring, etc.). The capacitance variation in the medium wave range is therefore 70—550 pF and for the long waves 90—570 pF. R.F. coils of 160  $\mu$ H give a medium wave-range of 200—550 m, whilst coils of 2150  $\mu$ H cover a long wave-range of 830—2050 m.

The aerial is coupled inductively and the voltage gain, constant over the whole wave range, amounts to a factor of three. The self-inductances of the R.F. coils are adjusted to the correct values with short-circuited aerial coil: the aerial coupling is satisfactory when the variation in self-inductance of the tuning coil, by short-circuiting the aerial coil, is 3 % in the medium wave range and 7 % on the long waves.

### *Oscillator circuit.*

In order to limit frequency drift as much as possible and ensure uniform oscillation throughout the whole wave-range, the oscillator circuit is connected to the anode of the triode section of the ECH 21 and, further, to avoid direct contact between the oscillator circuit and the D.C. anode voltage, parallel feed across a 22,000 Ohm resistance is employed. The grid condenser and leak  $C_g$  and  $R_g$  respectively are of such values that squegging oscillation is out of the question. The padding condensers are fixed, with trimmers across them, to provide the necessary accuracy of adjustment.

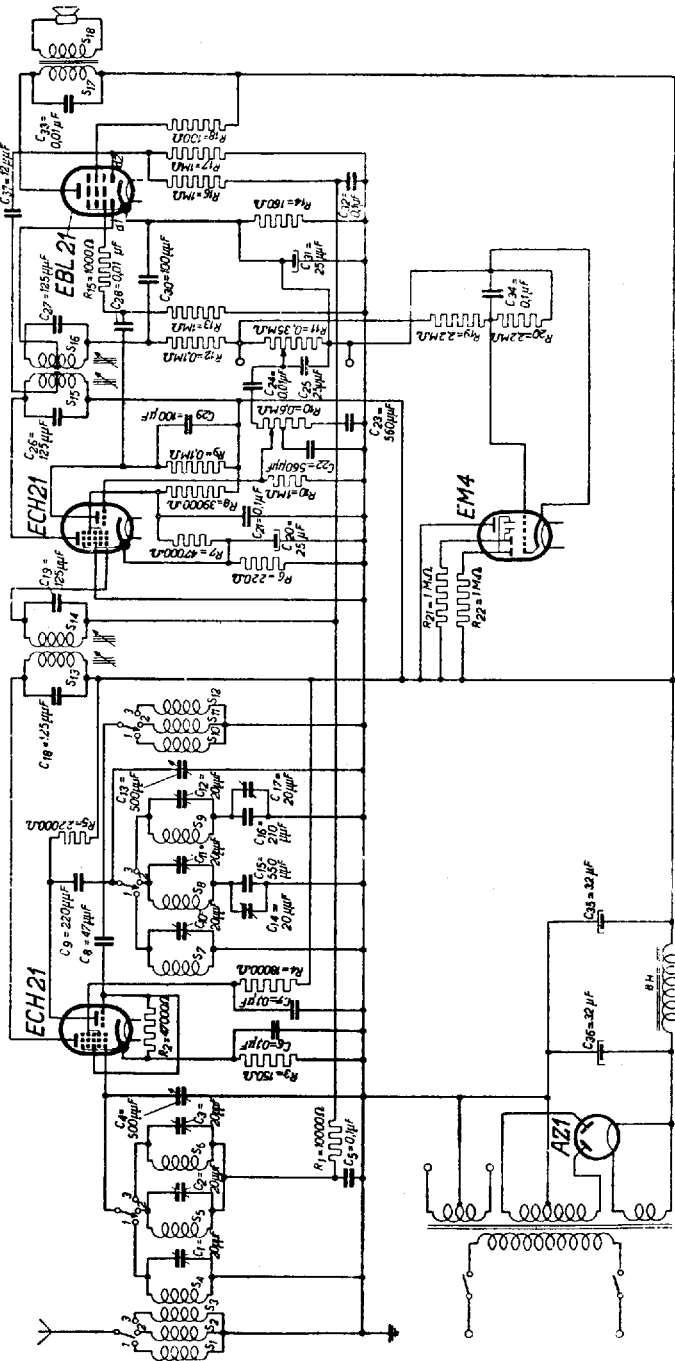

39033

Fig. 1  
 Theoretical circuit of superheterodyne receiver equipped with ECH 21, ECH 21, EBL 21, EM 4 and AZ 1 valves.  
 The denominations  $d_1$  and  $d_2$  of the diodes of the EBL 21 have to be interchanged.  
 Circuit given without any guarantees in respect of patent rights.

### *Mixer stage*

The voltage for the second and fourth grids of the ECH 21 is obtained from a series resistance  $R_2$  of 18,000 Ohms, thus obtaining a sliding screen voltage which is very favourable from a point of view of distortion. In order to avoid too much frequency drift when receiving short waves, the ECH 21 is not controlled in that range. Grid bias is obtained in the usual manner by means of a cathode resistance  $R_3$ , of 150 Ohms. The gain in the mixer stage amounts to a factor of about 120.

### *I.F. stage*

The I.F. is 470 kc/s. The self-inductances are iron-cored coils, of inductance abt 1 mH, thus ensuring high circuit quality; condensers in the I.F. circuit, of 125 pF, are of high quality in order to meet the requirements imposed on these circuits. The latter are trimmed to the correct frequency by adjusting the iron cores.

### *I.F. amplifier stage*

The heptode part of the second ECH 21 acts as I.F. amplifier. Voltages for the second and fourth grids are tapped from a potentiometer (39,000 + 47,000 Ohms), the current flowing through this potentiometer passing also through the cathode resistance  $R_6$ . This current is sufficiently high to limit the effect of the heptode control upon the grid bias of its triode section. Screen feed by means of a potentiometer is less satisfactory than feeding through a series resistance, in view of cross modulation, and if the latter effect is of great importance the screen may also be fed by means of a resistance of 47,000 Ohms. In this case care must, however, be taken that current also flows through the cathode resistance  $R_4$ , and this can be derived from the feed voltage, via a 47,000 Ohms resistance. The I.F. gain factor is about 100.

### *Diodes for detection and automatic gain control*

Diode  $d_2$  of the EBL 21 is employed for detection purposes and  $d_1$  for the automatic gain control; both are connected to tappings in the second I.F. transformer (ratio 2 : 1), thus avoiding distortion due to retroaction of the A.G.C. system, whilst the effect of capacitances of the diode anodes upon coupling of the I.F. transformer is also reduced.

Grid bias for the output valve acts simultaneously as delay voltage for the A.G.C. and becomes effective only when the aerial voltage is about 9 times the normal aerial input, that is at a signal of the order of 100  $\mu$ V. At a signal of this strength the output valve, when fully modulated, delivers its maximum rating of 4.5 W, with 10 % distortion.

### *A.F. amplifier stage*

The triode section of the second ECH 21 is used as A.F. amplifier, giving a gain factor of 10 with anode loading resistance of 0.1 M Ohm. As the grid bias furnished by the cathode resistance serves both the triode and the heptode sections, certain precautions are necessary. In the first place care must be taken to ensure that variation in the anode current of the heptode section, due to the control, does not have too marked an effect on the anode current of the triode section, and in this connection it should be remembered that the current in the potentiometer  $R_7 + R_8$  passes also through the cathode resistance. Secondly, due to the curvature of the characteristic, a weak A.F. component (anode bend detection) occurs in the anode current of the heptode section, which component, by reason of the common cathode resistance, produces a residual signal in the grid circuit of the triode. To avoid trouble on this account, the cathode resistance is decoupled with a large condenser (25  $\mu$ F). The condenser  $C_{22}$ , together with the resistance  $R_{10}$  of 0.6 M  $\Omega$  form a simple tone control.

A gramophone pickup can be connected direct to the volume control. To prevent distortion of the diode current a limiting resistance of 0.1 M Ohms is also included.

*Output stage*

The output pentode of the EBL 21 delivers no less than 4.5 W with 10 % distortion. Two resistances of 100 and 1000 Ohms respectively are included in the leads to the screen and control grid to eliminate parasitic oscillation.

*Electronic tuning indicator*

The electronic tuning indicator is controlled by the rectified signal voltage across the volume control, for which purpose the cathode of the EM 4 is connected to that of the EBL 21. Since the maximum control voltage would otherwise be too high for the grid swing of the EM 4, this voltage is taken from a potentiometer consisting of two resistances of 2.2 M Ohms each.

*Power section*

An AZ 1 is used as rectifier. Two electrolytic condensers of 32  $\mu$ F and a choke of 8 H ensure adequate smoothing; the potential at the output side of the smoothing filter is 260 V DC at 66 mA and the current consumption in the different stages is as follows:

1. ECH 21	$I_{aH}$	= 3.0 mA	
	$I_{(g_2 + g_4)}$	= 6.0 mA	
	Current through potentiometer	= 2.5 mA	
	$I_{aT}$	= 3.5 mA	
2. ECH 21	$I_{aH}$	= 5.3 mA	
	$I_{(g_2 + g_4)}$	= 3.5 mA	
	$I_{aT}$	= 2.0 mA	
EBL 21	$I_a$	= 36 mA	
	$I_{g_2}$	= 4 mA	
Total		65.8 = approx. 66 mA.	

**TECHNICAL DATA**

1) *Sensitivity* ( $W_o = 50$  mW)

at the output valve	0.5 V	} A.F. gain factor of 10	
at the triode part of the second ECH 21	0.05 V		
at the diode	0.26 V	} I.F. gain factor of 100	
at the heptode part of the second ECH 21	2.6 mV		
at the frequency changer	22 $\mu$ V	} conversion gain factor 120	
at the aerial	10 $\mu$ V		} voltage gain factor about 2.

2) *Selectivity*

Attenuation due to variation in tuning between +4.5 and -4.5 kc/s 1 : 10.

Attenuation due to variation in tuning between +8 and -8 kc/s 1 : 100.

3) *Automatic gain control curve*

The following points on the A.G.C. curve are given to illustrate the working of the control:

	×	normal input voltage corresponds to	1 ×	normal output voltage
2.2	×	.. .. .	2 ×	.. .. .
4.4	×	.. .. .	4 ×	.. .. .
12	×	.. .. .	8 ×	.. .. .
200	×	.. .. .	16 ×	.. .. .
7000	×	.. .. .	32 ×	.. .. .

TABLE OF COILS

Coil	No. of turns	Self-induct.	Type of winding	Diameter of former in mm	Wire thickness in mm	Kind of wire
S1	23	—	layer	14	0.1	enamelled
S2	319	—	wave	7	0.1	„
S3	950	—	„	7	0.07	„
S4	10	—	layer	14	1	„
S5	97	160 $\mu$ H	wave	7	15 $\times$ 0.04	litz
S6	366	2150 $\mu$ H	„	7	0.1	enamelled
S7	7	—	layer	14	0.1	„
S8	50	—	wave	7	0.1	„
S9	100	—	„	7	0.1	„
S10	9	—	layer	14	1	„
S11	60	75 $\mu$ H	wave	7	0.1	„
S12	128	320 $\mu$ H	„	7	0.1	„
S13	155	1 mH	„	iron core 7	24 $\times$ 0.04	litz
S14	155	1 mH	„	7	24 $\times$ 0.04	„
S15	155	1 mH	„	7	24 $\times$ 0.04	„
S16	155	1 mH	„	7	24 $\times$ 0.04	„

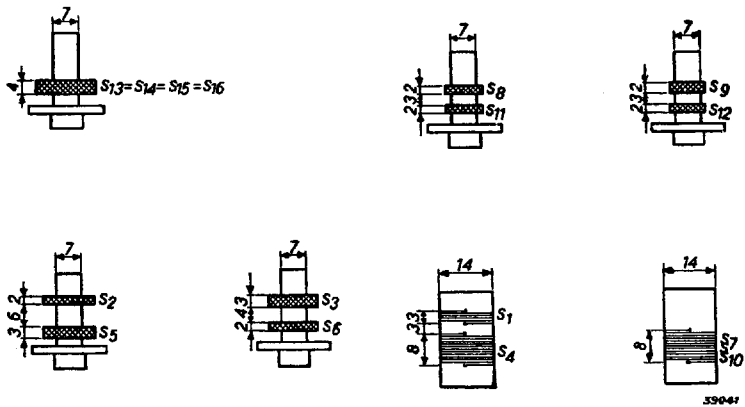

Fig. 2  
Sketches of coils used in this 3-valve receiver.



## II. A.C. Superheterodyne 4-valve receiver

*Valves used:* ECH 21—EF 22—EF 22—EBL 21—EM 4—AZ 1.

### *Wave ranges*

Long waves:       830 —2050 m.  
Medium waves:    200 — 550 m.  
Short waves:     15.5— 52 m.

### *Description*

This is a high quality receiver in the average price class. The use of a separate valve for A.F. amplification makes it possible to employ considerable inverse feedback and the outstanding quality of the receiver is enhanced by the "three-diode" arrangement included in the circuit.

### *R.F. circuit*

The different wave ranges are selected by means of a switching arrangement on the coils. As already seen, this is preferable to short-circuiting of parts of the coils. Whistling can be eliminated by including a filter circuit tuned to 470 kc/s between aerial and earth. It is good practice to screen the short and medium wave aerial coils from the oscillator circuit and the two former circuits should further be operated by individual switches (2 separate switch-segments are then required). The R.F. circuits are based on a variable condenser of 20—500 pF. For the medium and long wave ranges values of 50 and 70 pF have been taken to cover the zero capacitance (trimmers, wiring etc.) and on medium waves the capacitance variation is therefore from 70 to 550 pF, on long waves 90—570 pF. R.F. coils of 160  $\mu$ H serve the medium wave range of 200 to 550 m and coils of 2150  $\mu$ H the long waves from 830—2050 m. The aerial is coupled inductively and the voltage gain, which is constant throughout the whole range, amounts to a factor of 3. The self-inductance of the R.F. coils is trimmed to the correct value with the aerial coils short-circuited and good results can be obtained only when the self-inductance of the tuning coil, with aerial coil shorted, decreases 3 % in the medium wave range and 7 % on long waves.

### *Oscillator circuit*

The tuned oscillator circuit is incorporated in the anode circuit of the triode part of the ECH 21. In this way the effect of grid capacitances (which are the most subject to variation) upon the oscillator circuit are limited as much as possible. In order that the oscillator circuit shall be isolated from the D.C. anode voltage, the anode is fed by means of a resistance of 22,000 Ohms, the oscillator circuit being coupled to the anode circuit through a 220 pF condenser. The value of the latter is such that oscillation is kept as constant as possible throughout the whole wave range. Frequency drift due to the automatic gain control or to fluctuations in the mains voltage is limited not only by including the tuned circuit in the anode circuit but also, making use of the circumstance that frequency drift is occasioned mainly by the coupling between the oscillator circuit and the R.F. input circuit which is tuned to another frequency. Such coupling is set up by the capacitance between the input grid of the heptode section and the third grid, which is connected to the oscillator. As this capacitance is produced partly by the space charge, it is dependent on various feed voltages, which thus affect the tuning of the oscillator circuit by way of the input capacitances. Now, the space charge capacitance (induction effect) is unilateral, that is, the third grid is able to induce a voltage on the input grid, whereas the reverse does not apply. If, therefore, the constant capacitance of the input grid with respect to the third grid is compensated, the oscillator circuit can certainly induce a potential in the input circuit, but this has no retroactive effect on the oscillator circuit and the tuning remains

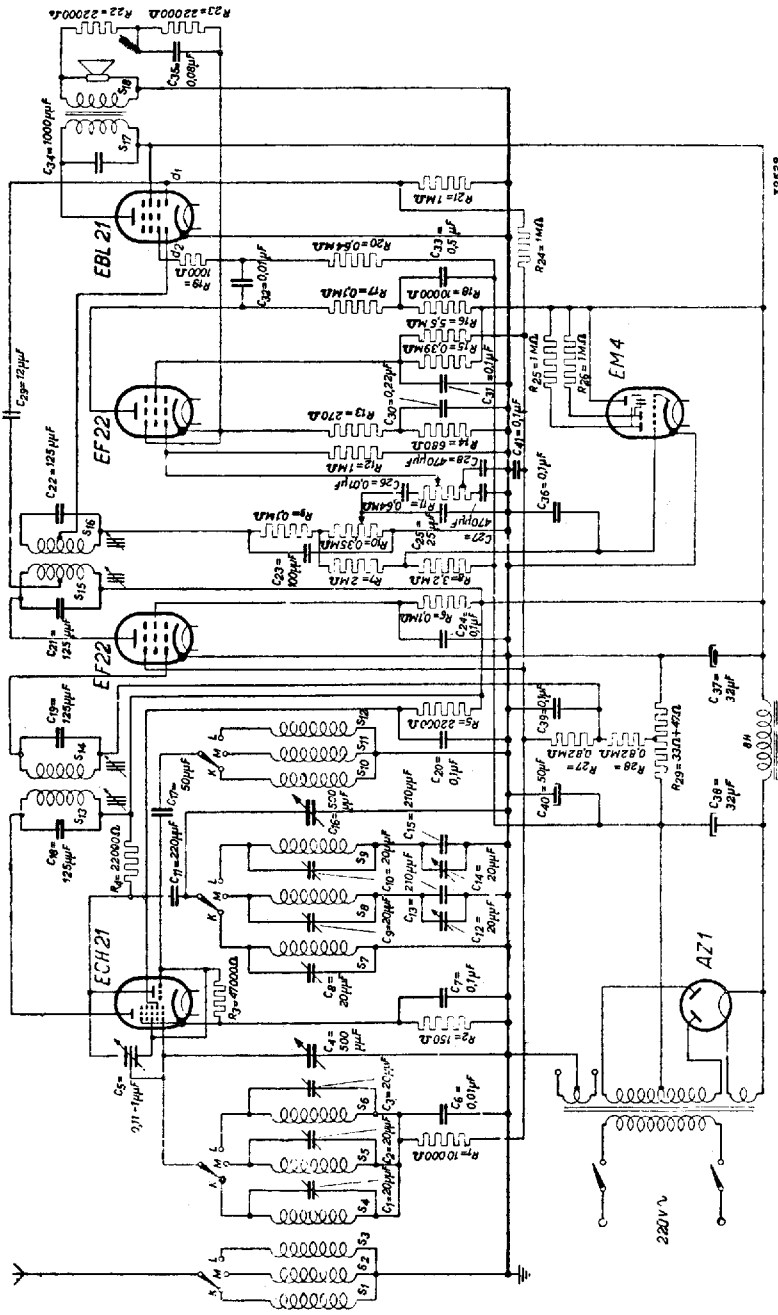

39529

Fig. 1  
Theoretical circuit of superheterodyne 4-valve receiver. Circuit given without any guarantees in respect of patent rights.

unaltered. Such compensation is introduced by means of a differential condenser which capacitively couples the input grid to the anode of the triode on the one hand and to the grid of the triode (third grid of the heptode section) on the other. The "sense" of the reaction is such that the coupling with the anode, produced by the correct setting of this condenser, is completely cancelled out by the coupling with the grid. This device reduces frequency drift at a wavelength of 15 m, and with maximum control on the valve, to a maximum of 1.5 kc/s, thus enabling the valve to be included in the automatic gain control in the short wave as well as in other ranges.

The construction of the differential condenser is very simple and Fig. 2 illustrates it; the variable electrode *c*) has a capacitance to the other electrodes *a*) and *b*) of maximum 1 pF and minimum 0.1 pF (approx.). To set this condenser, the procedure is as follows. A valve-voltmeter reading to some tenths of a volt is connected across the input circuit. The set is then tuned to 15 m and the voltage induced by the oscillator section of the valve is reduced to a minimum by means of the condenser. The grid current flowing in the grid leak of the oscillator triode at the beginning and end of the wave range is then roughly:

- 300—100  $\mu$ A on short waves
- 260—180  $\mu$ A on medium waves
- 100—180  $\mu$ A on long waves.

The values of the grid leak and condenser are such that over-oscillation is rendered impossible. The padding condensers are of the fixed type, with trimmers across them for accurate adjustment to the correct values.

*Mixer stage*

Voltage for the 2nd and 4th grids of the ECH 21 is obtained from a resistance and the screen voltage is therefore sliding. The gain factor in respect of the mixer stage, including the I.F. transformer, is 200.

*I.F. stage*

To ensure a satisfactory control characteristic, the screen of the I.F. valve EF 22 is fed through a resistance of 0.1 M Ohm. The third grid is included in the A.G.C.-circuit (three-diode circuit) which means that the cathode is earthed and that another method of obtaining grid bias has to be adopted. For this purpose the resistance providing grid bias for the output valve is tapped, with a potentiometer ( $R_{27} - R_{28}$ ;  $2 \times 0.82$  M Ohm) between this tapping and the control voltage: the grid bias for the EF 22 is thus supplied partly by the fixed tapping and partly by the A.G.C. circuit and the advantage of this arrangement is that the I.F. valve is not controlled to the same extent as the mixer valve. The total gain factor in the I.F. stage is 100.

*Diodes for detection and automatic gain control*

Diode  $d_2$  of the EBL 21 is employed for detection and diode  $d_1$  for the A.G.C. Both diodes are connected to tappings on the I.F. transformer in the ratio of 1 : 2, so as to reduce damping in the I.F. circuits.

The A.G.C. diode is biased and delay is obtained since the A.G.C. circuit is shunted across the smoothing filter  $R_{24} - C_{41}$  by the third grid of the EF 22, which is connected to a positive potential across  $R_{16}$  and  $R_{15}$ . The control becomes operative only when the diode  $d_1$  acquires a negative potential across  $R_{21}$  sufficiently large to quench the third

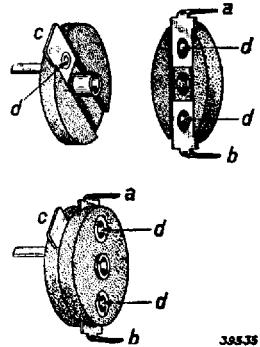

Fig. 2  
Construction of a low-value differential condenser. Top; Left and right half-sections of the condenser. (a) stationary electrode; (b) second stationary electrode; (c) rotating plate, adjustable with respect to electrodes (a) and (b); (d) eyelets, by means of which the electrodes (a), (b) and (c) are attached to the bakelised paper discs. Bottom; The assembled condenser.

grid (suppressor grid of the first EF 22); this takes place when the signal on the aerial is in excess of  $90 \mu\text{V}$ , or that on the diode greater than 4.5 V.

#### *A.F. amplifier stage*

The total gain factor of the EF 22 is 70 and this high gain permits of considerable inverse feedback. In the circuit in question the feedback factor is 7, so that the actual A.F. gain factor is 10.

The feedback voltage is applied to the cathode circuit, being tapped from the potentiometers  $R_{22}\text{-}R_{23}\text{-}C_{35}$  and  $R_{13}\text{-}R_{14}\text{-}C_{30}$  across the voice coil of the loudspeaker. The values of these resistances and condensers have been so chosen as to permit of the frequency curve being slightly flattened by the impedance of the speaker.

A tone control  $C_{27}\text{-}R_{11}\text{-}C_{28}$  is provided between the volume control and the grid, by means of which the high tones can be more or less attenuated.

#### *Output stage*

The output pentode delivers an output of 4.5 W with 20 % distortion. In view of the arrangement of the A.G.C. circuit, no resistance is used in the cathode circuit. The grid leak may not, therefore, exceed 0.64 MOhm. A stopper resistance of 1000 Ohms is connected to the control grid to prevent parasitic oscillation.

#### *Tuning indicator*

The electronic tuning indicator is controlled by the rectified signal voltage. A potentiometer  $R_7\text{-}R_8$  is included across the volume control  $R_{10}$  to reduce the direct voltage to a value suitable for the EM 4, whilst simultaneously smoothing the A.F. voltage, in conjunction with a condenser  $C_{36}$ .

#### *Power section*

The output voltage from the smoothing filter is about 250 V at 71 mA, D.C. An AZ1 valve is employed as rectifier. Smoothing is effected by means of two  $32 \mu\text{F}$  electrolytic condensers and an 8 H choke.

### **TECHNICAL DATA**

*Sensitivity* (to give an output of 50 mW):

at the output valve	0.5 V	at the I.F. valve	4.5 mV
at the A.F. valve	0.05 V	at the mixer valve	20 $\mu\text{V}$
at the detector diode	500 mV	at the aerial	appr. 10 $\mu\text{V}$

#### *Selectivity*

Attenuation for a variation in tuning of +4.5 and -4.5 kc/s: 1 : 10.

Attenuation for a variation in tuning of +7.5 and -7.5 kc/s: 1 : 100.

### III. Three-valve superheterodyne receiver for 220 V AC/DC operation

*Valves used:* UCH 21—UCH 21—UBL 21—UY 21.

#### *Description*

This is intended to figure as a low-priced receiver. Only three receiving valves are required, the second UCH 21 acting as a double valve, for which reason the performance is equal to that of any ordinary 4-valve set. Again, the set can be operated only on 220 V mains, this representing a considerable saving in switches and resistances. Inverse feedback and tone control in the A.F. section are dispensed with, also for reasons of economy.

The use of the small key type of valve also contributes towards the economy of the receiver, which, taken all round, is both small in dimensions and low in price.

#### *Wave-ranges*

900—2000 m

200— 590 m

15— 50 m

#### *Coils*

The R. F. and oscillator circuits are the same as in the circuit I on p. 58: for dimensional sketches and tables of coils the reader is referred to the relevant data.

#### *Oscillator circuit*

To limit frequency drift as much as possible and ensure uniform oscillation throughout the whole wave range, the oscillator circuit is incorporated in the anode circuit of the triode side of the UCH 21. Parallel feed is employed in order to isolate the oscillator circuit from the D.C. anode voltage. The values of the grid leak and condenser  $R_g$  and  $C_{13}$  are so chosen that the possibility of squegging is excluded. The padding condensers consist of fixed capacitances with trimmers in parallel for adjustment to the correct values.

#### *Mixer stage*

Voltage is applied across a resistance  $R$ , to the 2nd and 4th grids of the UCH 21 and the resultant sliding screen voltage maintains distortion at a very low level, even with gain control. In order to keep the cost of the receiver as low as possible, no special measures are taken to limit frequency drift arising from control on the amplification and, to avoid too much drift during short-wave reception, the UCH 21 is not controlled in that range. In the medium and long wave ranges the grid bias is controlled by the A.G.C.; on short waves the bias is fixed.

The gain factor in respect of the mixer stage is 120.

#### *I.F. circuits*

The intermediate frequency is 470 kc/s. Iron cored inductances of abt. 1 mH are used in the I.F. circuits, thus ensuring high circuit quality. The condensers in the I.F. circuits are of 100 pF and of high quality to guarantee the desired performance here. The I.F. circuits are trimmed to the correct frequency by means of the iron cores.

#### *I.F. amplifier stage*

For the I.F. amplification the heptode of the second UCH 21 is used. Grids 2 and 4 are fed through a resistance, giving sliding screen voltage. The third grid is connected to the cathode.

Grid bias is taken from the A.G.C. circuit, this being necessary since the heptode and

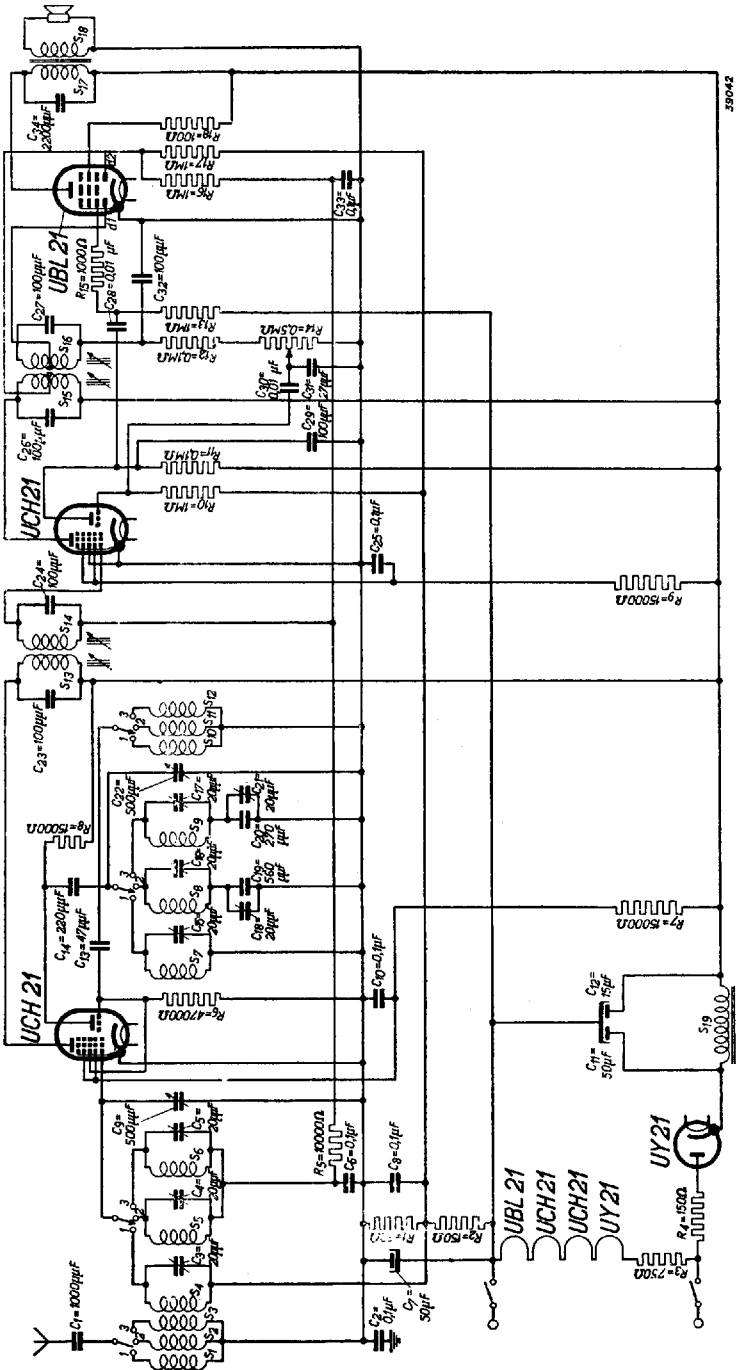

- 1 KW SW OC
- 2 MW HW PD
- 3 LW LW 5-C

Theoretical circuit of 8-valve super heterodyne receiver for 220 V AC/DC mains operation.  
Circuit given without any guarantee in respect of patent rights.

A condenser of about 12pF has to be added between the tapping of S15 and the diode d1 of the UBL 21.

triode sections of the valve share a common cathode. If a cathode resistance were employed, variations in current on the heptode side would lead to variations in the voltage across the resistance, which in turn would affect the working of the triode. I.F.gain factor = 100.

#### *Diodes for detection and A.G.C.*

Diode  $d_1$  of the UBL 21 is employed for detection purposes and diode  $d_2$  for the automatic gain control. Both diodes are connected to tapings on the second I.F.transformer, in the ratio of 2 : 1; distortion due to the retroaction of the A.G.C. is thus avoided, whilst the coupling of the I.F.transformer is then only slightly affected by capacitances of the diode anodes.

The delay voltage for the A.G.C. is tapped from a potentiometer  $R_1-R_2$  and applied to diode  $d_2$  by way of  $R_{17}$ . The same potential also serves as grid bias for the mixer valve, the I.F.and A.F.valves (heptode and triode sections of the second UCH 21 respectively). Cathode resistances with their associated condensers are therefore not required.

The mutual conductance in the uncontrolled condition is in consequence slightly lower, but the sensitivity, as shown by the electrical data, is still adequate.

#### *A.F. amplifier stage*

The triode portion of the second UCH 21 takes care of the A.F.amplification. The A.F.-voltage is tapped from the resistance  $R_{14}$  and applied to the grid of the A.F.valve through a condenser  $C_{30}$ . An anode coupling resistance of 100,000 Ohms gives a gain factor of 10.

#### *Output stage*

In this circuit the pentode UBL 21 yields a maximum output of about 5 W at 10 % distortion. Resistances of 100 and 1000 Ohms are connected in series with the screen and control grids respectively to prevent parasitic oscillation. As already mentioned, no cathode resistance is employed, in view of the A.G.C.

#### *Power section*

The four heaters are connected to the mains in series with a resistance of 750 Ohms. To limit ripple, the UBL 21 is connected to the negative end of the series, followed by the UCH 21 as I.F.and A.F.amplifier, another UCH 21 as mixer valve and, lastly, the UY 21.

A resistance of 150 Ohms is included in series with the UY 21 for protection purposes. Effective smoothing is provided by a dual electrolytic condenser of 50 + 15  $\mu$ F with a choke coil in the feed line. In very small receivers with a loudspeaker which is relatively insensitive to a frequency of 50 c/s, a simpler form of smoothing is sufficient: the choke may then be replaced by a resistance of about 1000 Ohms, the anode of the output valve being connected to the first smoothing condenser  $C_{11}$ .

### **ELECTRICAL DATA**

*Sensitivity* (to give an output of 50 mW):

at the output valve	0.6 V	} A.F.gain factor: 10
at the triode section of the 2nd UCH 21	0.06 V	
at the diode	0.25 V	} I.F.gain factor: 100
at the heptode section of the 2nd UCH 21	2.5 mV	
at the mixer valve	20 $\mu$ V	} conversion gain factor: 120
at the aerial	approx. 10 $\mu$ V	
		} volts gain factor: 2.

#### *Selectivity*

Attenuation for a variation in tuning of +4.5 and -4.5 kc/s 1 : 10.

Attenuation for a variation in tuning of +8 and -8 kc/s 1 : 100.

#### IV. 4-valve superheterodyne receiver for 110 V and 220 V AC/DC mains operation

*Valves used:* UCH 21—UF 21—UF 21—UBL 21—UM 4—UY 21.

In principle this receiver is the same as the A.C.receiver described under heading II; the main difference lies in the power section. The rectifier is a UY 21 valve. On 220 V mains the heaters are connected in series, as shown in the theoretical circuit (switch to R.H.side), whilst on 110 V mains the UBL 21 and UY 21, in series, are connected in parallel with the others, also in series with each other (switch to L.H.side).

#### TECHNICAL DATA

*Sensitivity* (to give an output of 50 mW):

at the output valve	0.5	V	} A.F.gain factor: 5
at the A.F.valve	0.1	V	
at the detector diode	0.45	V	} I.F.gain factor: 112
at the I.F.valve	4	mV	
at the mixer valve	30	$\mu$ V	} conversion gain factor: 133
at the aerial	8	$\mu$ V	

#### *Selectivity*

Attenuation for a variation of + 4 and — 4 kc/s in the tuning: 1 : 10.

Attenuation for a variation of + 8 and — 8 kc/s in the tuning: 1 : 100.

Attenuation for a variation of +14 and —14 kc/s in the tuning: 1 : 1000.



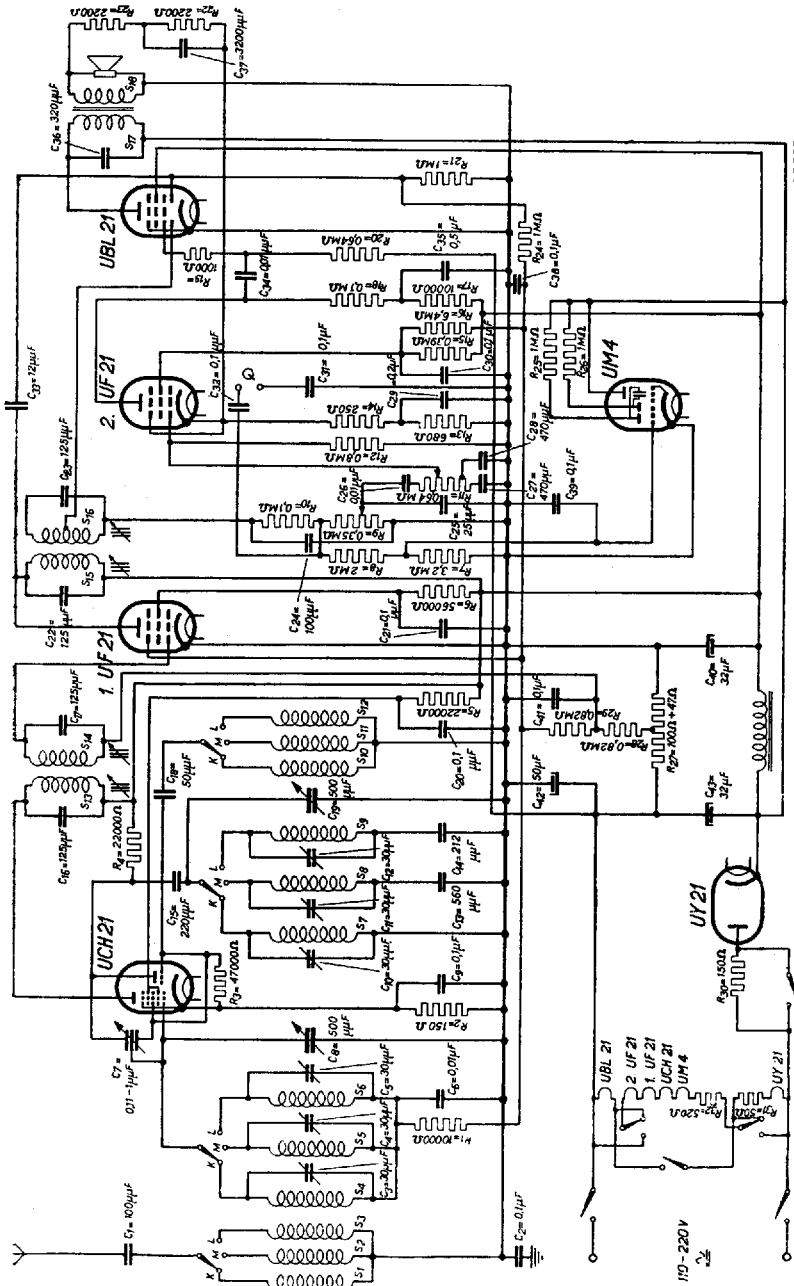

4 0083

Theoretical circuit of four-valve super-heterodyne receiver for 110 V and 220 V AC/DC mains operation.  
 Circuit given without any guarantees in respect of patent rights.



## **1.4 Volt battery valves for operation on dry batteries**

## The 1.4 V series of Battery Valves for operation on Dry Batteries

Filament current for battery receivers may be derived from a number of different sources, such as the ordinary lead accumulator, the nickel accumulator (Ni-Fe), the air-cell or the dry battery.

Until recently the lead accumulator has been almost the only type of battery used for the filament voltage, despite its many inconveniences. Not only has this type of accumulator to be constantly re-charged, having often to be carried great distances for this purpose, but, apart from the inconvenience and expense, the acid in the battery has to be periodically checked and renewed. In many instances the lead accumulator has been ousted by the air-cell, which can be transported without any liquid. This type of battery has a very long life, but it also has its disadvantages in that it is cumbersome, the cost is relatively high, and the battery itself is extremely sensitive to overloads.

In principle the nickel battery has the same disadvantages as the lead accumulator. Dry batteries were formerly employed only in exceptional cases, as they were very uneconomical where the current-drain exceeded a certain value which would in any case be passed when the existing 2-volt valves were conceived.

Experience has shown that the border line at which a dry battery becomes an economical proposition (including purchase price and maintenance), as compared with the accumulator, lies in the region of a current consumption of 250 mA. If the current is lower the life of the battery will be very much longer and the running costs correspondingly lower (generally speaking the increase in the life of a dry battery is greater than the decrease in current). It is therefore very important that the total filament current shall be as low as possible, and this is realised in the new series of valves. For example, the current consumption of a superheterodyne receiver fitted normally with four valves of the K-type (e.g. KK 2, KF 3, KBC 1, KL 5) would be 380 mA at 2 Volts.

Using the new D-valves (DK 21, DF 21, DBC 21 and DL 21) the total filament current is only 175 mA, this representing a very considerable saving.

In order to reduce the filament current two main requirements obtain:

- 1) the thickness of the emissive coating on the filament must be reduced and special high tensile material has to be employed for the filament proper;
- 2) the space between the cathode surface and the grid has to be reduced.

At a given temperature of the cathode surface, the consumption of filament current is proportional to the length and diameter of the filament, including the layer of emissive substances. Now the mutual conductance of the valve is

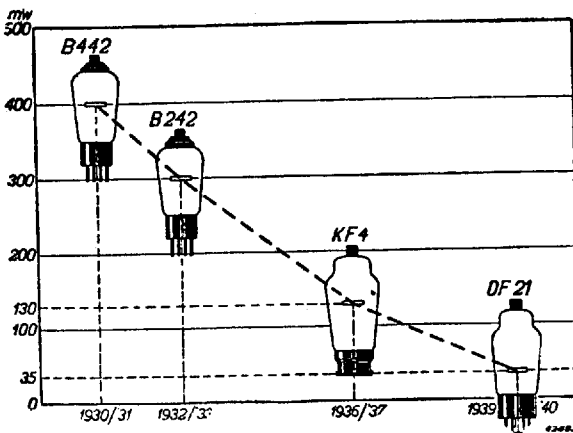

Fig. 1

Diagram showing the filament power of battery valves in the last decade.

not governed by the diameter of the filament, but—the dimensions of other electrodes being the same—only by the length of the wire, and this means that a reduction in the diameter of both wire and emissive layer results only in a decrease in filament current and, therefore, of the consumption also, provided that the temperature at the surface is not changed. In this way the current consumption can be decreased without affecting the mutual conductance.

The diameter of the filament in the K series of valves is  $25\mu$ , to which must be added 2 times  $30\mu$  for the emissive coating, making a total of  $85\mu$ . An entirely new manufacturing process has made it possible to reduce the thickness of the coating to  $10\mu$  in the new D type valves, but an equally important factor, as already mentioned, is the wire diameter. Tungsten wire possesses a very much higher ultimate strength than the often used nickel wire, so that, in place of a  $25\mu$  wire as employed in earlier types of battery valves, tungsten filament of only  $10\mu$  is

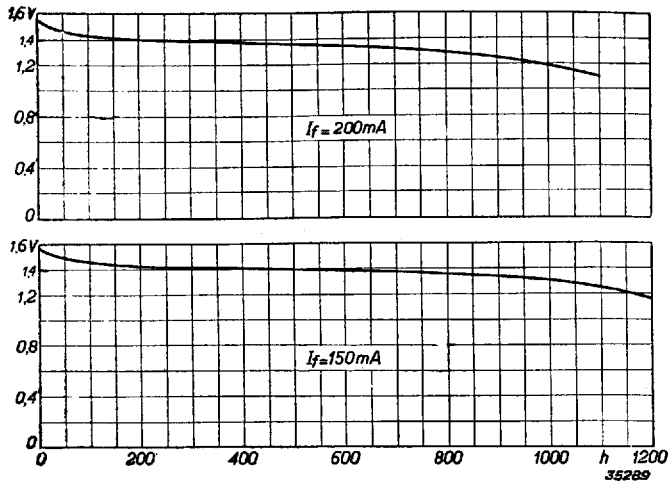

Fig. 2  
Characteristic curves of the life of a battery giving a nominal voltage of 1.4 at about 225 Hours, assuming that the receiver is used for 4 hours per day. The upper curve was plotted in respect of a receiver having a total filament current of 200 mA. The life of the battery is then about 1100 hours. Using the battery 4 hours per day, this means a total life of about 9 months. On a total filament current of 150 mA (lower curve), employing the new "economy" valves, the life of the battery can be extended to 1200 hours.

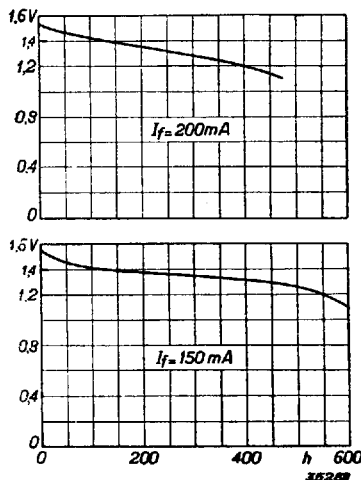

Fig. 3  
Characteristic curves in respect of batteries giving a normal voltage of 1.4 V at 90—100 A/hours: here again it is assumed that the battery is used for 4 hours per day. The top curve refers to a receiver having a total filament consumption of 200 mA and the lower curve to a consumption of 150 mA. The life of the battery is admittedly only about one-half of that indicated in Fig. 2, but the weight of the battery is correspondingly lower. These curves relate to a number of good quality batteries.

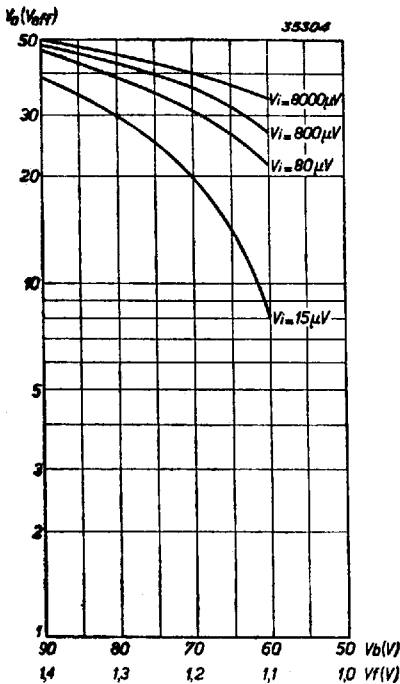

Fig. 4

Alternating output voltage as a function of H.T. battery and filament voltage in respect of different alternating input voltages, in a receiver fitted with DK 21, DF 22, DBC 21 and DL 21 valves. Due to the compensating action of the automatic gain control, the alternating output voltage does not drop very steeply on strong input voltages. Conditions are less favourable, however, with very weak signals, below the level at which the A.G.C. operates (e.g. at  $V_i = 15 \mu V$ ).

Batteries of this type are relatively heavy, however, ranging from 3 to 3.8 kg, according to make, and are therefore suitable only for receivers which are not frequently moved about. Fig. 3 shows the curves relating to smaller batteries weighing about 1 to 1.5 kg which can also be employed in portable sets.

Even smaller batteries are made, but their uses are limited, since too frequent renewal of batteries involves a great deal of inconvenience.

Sometimes combination batteries are employed, consisting of H.T. and filament batteries in one, but the disadvantage of these is that the two sections have seldom the same working life.

The upper and lower limits for the filament voltage of the 1.4 V battery valves have been placed at 1.1 V and 1.5 V respectively.

To give an idea of the behaviour of a battery receiver working on declining filament and anode voltages, Fig. 4 shows a number of curves for alternating output voltage as a function of battery voltage, with alternating input voltage as parameter. From these curves it will be clearly seen that a drop in the battery voltages manifests itself only on very weak signals, below the point at which the automatic gain control commences to operate.

now used, without any danger of breakage. The overall diameter of the cathode of the D-valve is therefore only  $30 \mu$ , which compares very favourably with the previous thickness of  $85 \mu$ . Needless to say, very much less power is required to raise this wire to the same surface temperature as before; moreover, for the same electrical characteristics and the greatest factor of safety, it has been possible to reduce the distance from the cathode to the control grid. With a corresponding reduction in the length of the filament, an even greater decrease in current consumption has therefore been realised.

The design of the D type of valve was based on the use of a dry battery of 1.4 V rated voltage, and the filament operates on 1.4 V or multiples thereof. The advantage of this is that the filament is subjected to the maximum battery voltage only for very short periods. Various measurements on dry batteries have shown that the filament voltage falls about 10 % below the nominal battery voltage only some time after the first half of the battery's life. Figs. 2 and 3 give the discharge characteristics of a dry battery of 1.4 V rated voltage. Two batteries of different size were employed for these tests.

Fig. 2 illustrates the curves in respect of a large battery: on a current drain of 150 mA (as in the case of the low-current valves DK 21, DF 21, DAC 21 and DL 21) it appears that the battery voltage drops to 10 % of the nominal value only after as much as 1000 working hours. It is seen, moreover, that once the battery voltage has reached this value it declines rapidly, approaching 1.1 V after another 200 hours. At the higher current of 200 mA, the limit value of 1.1 V is reached in about 1100 hours, in which case the voltage will be 10 % of the nominal value after about 700 hours' use.

Provided the filament current is suitably adjusted, the new valves can be employed not only in battery sets (driven by dry batteries or accumulators), but also in AC/DC-battery receivers, which will undoubtedly gain in popularity in the future, owing to the fact that they can be operated on batteries, A.C. or D.C. mains without any special auxiliary apparatus such as vibrator-converters, or the use of complicated circuits. To meet the various demands met with in practice, two series of D-valves have been developed, namely:

### 1. The "Economy" or low-current valves

In this series the required filament power has been reduced to the extreme minimum. There are four types, viz:

DK 21 Octode, with 50 mA filament current. Despite this unusually low current, the mutual conductance is 500  $\mu\text{A/V}$ .

DF 21 R.F. and I.F. pentode: filament current only 25 mA.

DAC 21 Diode-triode: filament current 25 mA. The gain factor of the triode section is 40.

DL 21 Pentode: filament current 50 mA. At an anode and screen voltage of only 90 V this valve will deliver 170 mW.

Comparison of these valves with the corresponding 2 V types in the K-series shows that the saving in current is quite considerable. Taking, for example, the four valves of a conventional superhet receiver, the following figures are obtained:

1.4 V type	Fil. current	2 V type	Fil. current
DK 21	50 mA	KK 2	130 mA
DF 21	25 mA	KF 3	50 mA
DAC 21	25 mA	KBC 1	100 mA
DL 21	50 mA	KL 5	100 mA
Total fil. current	150 mA	Total fil. current	380 mA

It is thus possible, using the 1.4 V valves mentioned above, to construct a superhet receiver having a total filament consumption of 150 mA: using the equivalent K-type valves, the total consumption would be 380 mA.

### 2. Valves of higher power

This range of valves includes a number of types of which the electrical details are almost identical with those of the earlier K-types; in view of their superior performance as compared with the low-current valves, the current consumption is of course somewhat higher than in the latter. In contrast with the 2 V valves these new valves provide, however, a considerable saving in current. There are five different types:

DK 21 Frequency-changer octode, as already mentioned in the above range. The outstanding electrical characteristics of this valve enable it to be used in conjunction with the valves of this series.

DF 22 R.F. pentode with a filament current of 50 mA. This valve lends itself well to control. The maximum mutual conductance is 1.1 mA/V.

- DBC 21** Double diode triode: filament current 50 mA. The gain factor of the triode section is 25 and, by reason of the low impedance, this valve can also be transformer coupled.
- DLL 21** Double diode pentode for balanced output stages. Each of the electrode systems in this valve has a double filament, these being so arranged that either one or both can be utilised. Filament feed may be on the basis of 100 or 200 mA at a voltage of 1.4 V or 2.8 V.
- DM 21** Electronic indicator. This is the first electronic tuning indicator to be produced for use with battery receivers. The filament current is only 25 mA, making the indicator suitable for use in many different types of battery set. The anode voltage lies between 90 and 120 V.

The sensitivity and output power of a receiver constructed with the valves listed above are comparable to those of a mains-operated receiver. Using the DK 21, DF 22, DBC 21, DL 21 and DM 21, a high sensitivity receiver can be designed to incorporate delayed automatic gain control and tuning indicator, consuming only 225 mA at 1.4 V. A receiver of this type can be run from a dry battery and, with one of the types referred to in figure 2, a life of about 1000 hours may be anticipated. A similar receiver with K-type valves would take a total current of about 405 mA at 2 V; in other words, the introduction of the new D-valves has halved the filament current required. Finally, a word should be said regarding the DAH 50. This is a special valve comprising a diode and heptode with space-charge grid, owing to which latter feature the valve is able to operate on an anode potential of only 15 V. It is eminently suitable for midget portable sets with headphones.

This valve is described more fully in a later chapter.

All the valves in the D series have the 8-pin base with centre pilot pin, and the valve-holder to be employed with these valves must always be mounted in such a way that the valve is vertical. Should it be essential to mount the valve horizontally care must be taken to see that the filament pins are one under the other.



# DAC 21 Diode-triode

The great reduction in filament current has led to the development of a combined detector and A.F.amplifier valve, the DAC 21. At 1.4 V the filament current is only 25 mA (directly heated). In order to attain this very low current consumption, it was necessary to evolve a special technique in the construction of the filament, the second diode generally used for A.G.C.purposes also being dispensed with. The gain factor of the triode section, however, is remarkably high for a battery valve, this being at the same time necessary for adequate sensitivity.

In an R—C coupled circuit the DAC 21 will give a gain of 25 with minimum distortion (with a grid leak on the following valve of 1 MOhm); if it is any higher, say 2 MOhms, the gain will be even greater.

The diode portion is screened from the triode, so that all coupling between the two systems is avoided; the interelectrode capacitance between the diode and the grid and anode of the triode is extremely low.

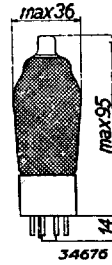

Fig. 1  
Dimensions in mm.

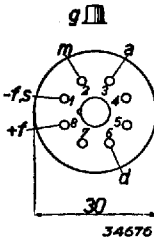
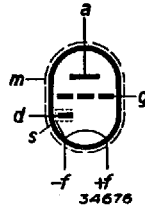

Fig. 2  
Arrangement and sequence of contacts.

## FILAMENT RATING

Filament feed: direct, by means of battery, rectified alternating current, or D.C.; series or parallel.

Filament voltage . . . . .  $V_f = 1.4$  V  
 Filament current . . . . .  $I_f = 0.025$  A

## CAPACITANCES

Anode-grid	$C_{ag} = 1.6$	pF
Anode-filament	$C_{af} = 3.3$	pF
Diode-filament	$C_{df} = 2$	pF
Diode-grid	$C_{dg} < 0.0025$	pF
Diode-anode	$C_{da} < 0.1$	pF
Grid-filament	$C_{gf} = 1.6$	pF

## TRIODE SECTION RATINGS

Anode voltage	$V_a = 90$	120	V
Grid bias	$V_g = 0$	0	V
Anode current	$I_a = 0.45$	0.75	mA
Gain factor	$\mu = 40$	40	
Mutual conductance	$S = 0.3$	0.4	mA/V
Internal resistance	$R_i = 0.13$	0.1	MOhm

# DAC 21

## OPERATING DATA: TRIODE SECTION employed as resistance-capacitance coupled A.F. amplifier

Battery voltage . . . . .	$V_b$	=	90 V		120 V
Anode feed resistance . . . . .	$R_a$	=	0.5 0.2 MOhms	0.5	0.2 MOhm
Grid bias . . . . .	$V_g$	=	0 0 V	0	0 V
Anode current . . . . .	$I_a$	=	0.081 0.137 mA	0.120	0.225 mA
Required alternating grid voltage for an effective output voltage of $V_o$ eff = 3 V . . . . .	$V_{i\text{ eff}}$	=	0.132 0.154 V	0.119	0.140 V
Voltage gain . . . . .	$V_o/V_i$	=	23 19.5	25	21
Total distortion at an alternating output voltage of $V_o$ eff = 3 V . . . . .	$d_{tot}$	=	1.0 1.2 %	0.5	0.7 %

### MAXIMUM RATINGS FOR THE TRIODE SECTION

Anode voltage . . . . .	$V_a$	= max. 135 V
Anode dissipation . . . . .	$W_a$	= max. 0.1 W
Cathode current . . . . .	$I_k$	= max. 3 mA
Max. external resistance between grid and filament . . . . .	$R_g$	= max. 3 MOhms
Grid current commences ( $I_g = +0.3 \mu A$ ) . . . . .	$V_g$	= max. $-0.2$ V
Minimum limit for filament voltage . . . . .	$V_f$	= min. 1.1 V
Maximum limit for filament voltage . . . . .	$V_f$	= max. 1.5 V

### MAXIMUM RATINGS FOR THE DIODE SECTION

Peak voltage on the diode . . . . .	$V_d$	= max. 125 V
Max. direct current through resistor . . . . .	$I_d$	= max. 0.2 mA
Diode current commences . . . . .	$V_d (I_d = +0.3 \mu A)$	= max. $-0.6$ V

### APPLICATIONS

The DAC 21 is suitable for diode detection and R—C coupled A.F. amplification. When used in conjunction with other valves in the D-series, this valve makes possible the design of receivers with extremely low current consumption. Since, for economy in current, no diode is provided for automatic gain control, the voltage for this purpose is taken from the detector diode. The filament electrode connected to pin No. 1 (see

Fig. 2) must be earthed, since the diode anode is mounted at that end of the filament, part of the latter of course being used for the diode. In the triode section, the negative end of the filament is slightly positive with respect to the negative filament pin, so that sufficient grid bias is obtained by earthing the grid through a resistance. The valve can thus be operated without any separate source of grid bias.

In view of the very low filament cur-

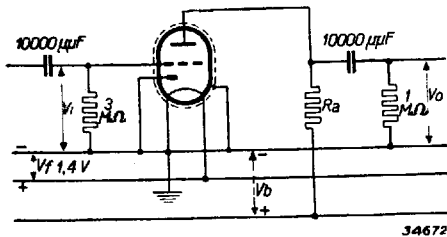

Fig. 3  
Skeleton circuit illustrating the symbols employed in the operating data.

rent of the DAC 21, two of these valves can also be used in an A.F. amplifier stage to drive a push-pull output stage: one of them then acts as R—C coupled A.F. amplifier, with the triode part of the other as phase inverter. The two valves together consume only 50 mA filament current and no input transformer is required for the output stage. The filament current of the DBC 21 is also 50 mA, but with this valve an output transformer is necessary for a push-pull output stage. When two DAC 21 valves are employed, two diodes are available, one for detection and the other for A.G.C. Moreover, the combined anode current of the two DAC 21 valves is only 0.2 mA, whilst that of the DBC 21 with transformer coupling is 1.9 mA. The arrangement with two DAC 21 valves in the A.F. driver stage is especially important when the double pentode DLL 21 is used, and Fig. 6 shows a circuit for this combination, in which the anode voltage may be 90—120 V. The triode section of the first DAC 21 operates as a normal A.F. amplifier with R—C coupling and modulates the “left hand” pentode of the DLL 21 across a coupling resistance of 0.5 M Ohm + 25,000 Ohms, with a 10,000 pF condenser.

The alternating grid voltage for the second DAC 21 is taken from the anode resistance of 25,000 Ohms of the first DAC 21, and the anode of the second is coupled to the grid of the “right hand” pentode, but with a phase displacement of 180°.

The filament of the DLL 21 is then connected for a current of 100 mA, since an ordinary dry battery would be too heavily loaded at 200 mA. The sensitivity of the combination, consisting of two DAC 21 and the DLL 21 valves, is about 0.12 V at a high tension voltage of 120 V. Delay voltage for

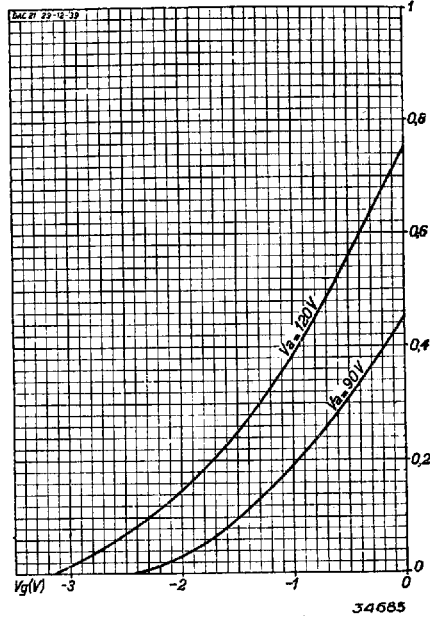

Fig. 4  
Anode current as a function of the grid bias at  $V_a = 90$  and 120 V.

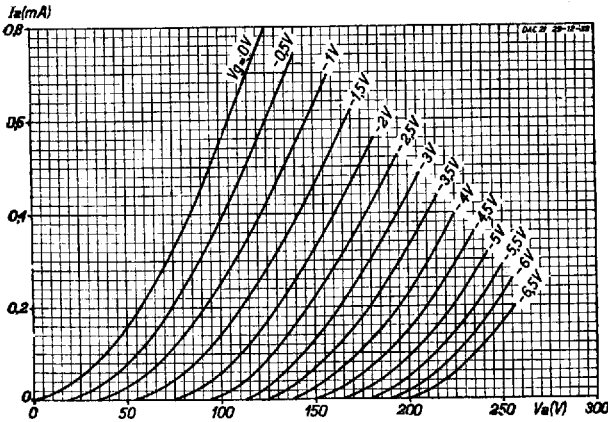

Fig. 5  
Anode current as a function of the anode voltage, with  $V_g$  as parameter.

the A.G.C. is obtained very simply by applying to the diode of the second DAC 21 a negative potential, obtained automatically from the voltage drop across a resistance in the negative return to the battery. Without signal, this voltage is -1.5 V and

this serves simultaneously as initial voltage for the controlled valves. Naturally, it is possible also to arrange the A.G.C.circuit on other lines, for instance by applying to the controlled valves (mixer and I.F.amplifier) a lower initial voltage and employing a control that is accordingly less effective.

In certain cases it may be desirable to feed the filaments of the valves by means of a good 4.5 V torch battery and this can be done by forming a 50 mA circuit, employing the DK 21 and DL 21 in series with the DAC 21 and DF 21 in parallel: the filament current of the two last mentioned valves is 25 mA, so that overall consumption is 50 mA. Should one of the filament pins fail to make good contact in its valveholder, the filament of the other valve will be heavily overloaded, and although this overload will not usually mean the destruction of the filament, the emission will nevertheless be impaired. The same thing happens when one of the valves is removed without first breaking the filament circuit, and if the arrangement in question is employed the necessary care must be taken that contact between the valve pins and the valveholders is as effective as possible.

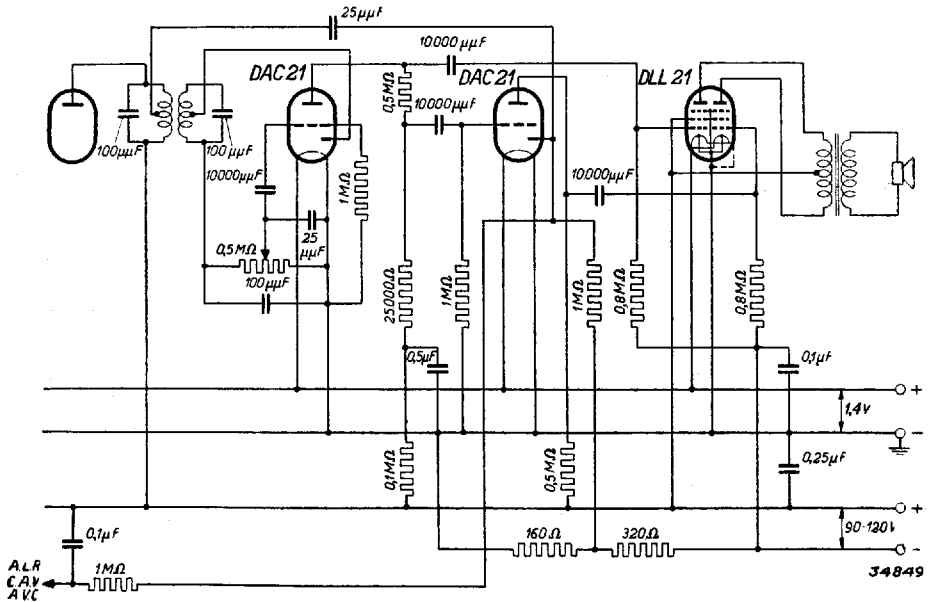

Fig. 6

Theoretical circuit showing method of employing two DAC 21 valves in a modulation stage preceding a push-pull output stage. Detection takes place at the diode of the first DAC 21, the diode of the second DAC 21 serving for the delayed A.G.C.

# DBC 21 Double-diode triode

This directly-heated double diode triode has a filament voltage of 1.4 V, at a current of 50 mA. The gain factor in respect of the triode section is 25 and the mutual conductance 0.85 mA/V at an anode voltage of 90 V or 0.9 mA/V at 120 V. The impedance is relatively low, being 30,000 and 28,000 Ohms at these anode voltages, so that the valve can serve not only as detector and R—C coupled A.F. amplifier, but can also be used with transformer coupling, this being important if a push-pull output stage using the DLL 21 is to follow. In contrast with the DAC 21, the DBC 21 has two diodes, one of which can be used for detection, whilst the other is available for automatic gain control.

As regards the construction of the DBC 21, this valve has virtually two filaments, each taking 25 mA: one serves the triode portion and the other the two diodes. The triode is screened from the diode part by a plate which almost completely separates the two sections electrostatically: the two filaments are wired parallel within the valve, and the screen is connected to the filament pin marked  $-f,s$  in Fig. 2. The diode marked  $d_2$  is mounted at that end of the filament which is in contact with pin  $-f,s$  and is therefore employed for detection (filament pin  $-f,s$  is to be earthed).

In this way the other diode automatically receives a small negative potential which serves for the automatic gain control, although, generally speaking, a slightly higher delay voltage is desirable.

## FILAMENT RATINGS

Filament supply: direct heating by means of a battery, rectified alternating current, or D.C.: series or parallel supply.

Filament voltage . . . . .	$V_f = 1.4$	V
Filament current . . . . .	$I_f = 0.050$	A

## CAPACITANCES

Anode-grid . . . . .	$C_{ag}$	= 2.6	pF
Grid-filament . . . . .	$C_{gf}$	= 1.7	pF
Anode-filament . . . . .	$C_{af}$	= 4.0	pF
Between diodes . . . . .	$C_{d_1d_2}$	< 1.2	pF
Diode 1-filament . . . . .	$C_{d_1f}$	= 2.4	pF
Diode 2-filament . . . . .	$C_{d_2f}$	= 2.0	pF
Between the 2 diodes and grid . . . . .	$C_{(d_1+d_2)g}$	< 0.01	pF
Between the 2 diodes and anode . . . . .	$C_{(d_1+d_2)a}$	< 0.1	pF

## RATINGS FOR THE TRIODE SECTION

Anode voltage . . . . .	$V_a = 90$	120	V
Grid bias . . . . .	$V_g = -0.5$	-1.5	V
Anode current . . . . .	$I_a = 1.4$	1.6	mA
Gain factor . . . . .	$\mu = 25$	25	
Mutual conductance . . . . .	$S = 850$	900	$\mu\text{A/V}$
Internal resistance . . . . .	$R_i = 30,000$	28,000	Ohms

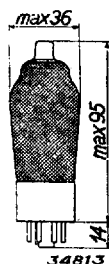

Fig. 1  
Dimensions in mm.

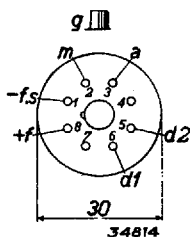
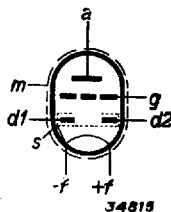

Fig. 2  
Arrangement and sequence of contacts.

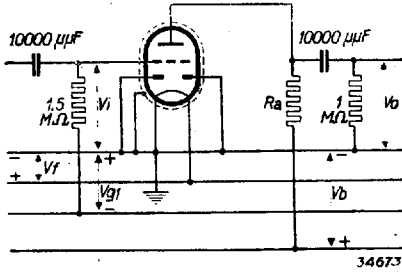

Fig. 3

Circuit diagram showing the triode section of the DBC 21 used as R.C. coupled A.F. amplifier, to illustrate the symbols employed in the Operating Data.

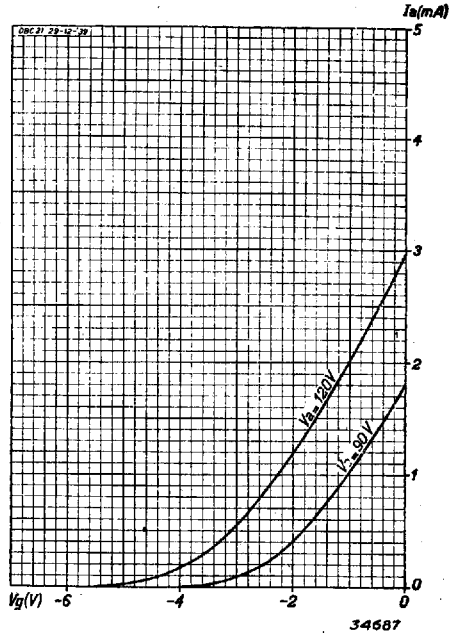

Fig. 4

Anode current as a function of the grid bias at  $V_a = 90$  V and  $120$  V.

**OPERATING DATA: triode section employed as resistance-capacitance coupled A.F. amplifier**

Battery voltage . . . . .	$V_b$	=	90	120 V
Anode resistance . . . . .	$R_a$	=	0.2	0.5 MOhms
Grid bias . . . . .	$V_g$	=	-0.5	-1 V
Anode current . . . . .	$I_a$	=	0.19	0.09 0.27 0.14 mA
Required alternating grid voltage for an effective output voltage of $V_{o\text{ eff}} = 3$ V . . . . .	$V_{i\text{ eff}}$	=	0.19	0.16 0.18 0.15 V
Voltage gain . . . . .	$V_o/V_i$	=	15.5	19 16.5 19.5
Total distortion at an alternating output voltage $V_{o\text{ eff}} = 3$ V . . . . .	$d_{to}$	=	0.7	0.5 1.0 0.8 %

**MAXIMUM RATINGS FOR THE TRIODE SECTION**

Anode voltage . . . . .	$V_a$	= max. 135 V
Anode dissipation . . . . .	$W_a$	= max. 0.3 W
Cathode current . . . . .	$I_b$	= max. 3 mA
Max. external resistance between grid and filament . . . . .	$R_{gf}$	= max. 3 M Ohms
Grid current commences at ( $I_g = +0.3 \mu A$ ) . . . . .	$V_g$	= max. -0.2 V
Minimum limit for filament voltage . . . . .	$V_f$	= min. 1.1 V
Maximum limit for filament voltage . . . . .	$V_f$	= max. 1.5 V

**MAXIMUM RATINGS FOR THE DIODE SECTION**

Peak voltage on diode $d_1$ . . . . .	$V_{d_1} = \text{max. } 125 \text{ V}$
Peak voltage on diode $d_2$ . . . . .	$V_{d_2} = \text{max. } 125 \text{ V}$
Max. D.C. through resistor of diode 1 . . . . .	$I_{d_1} = \text{max. } 0.2 \text{ mA}$
Max. D.C. through resistor of diode 2 . . . . .	$I_{d_2} = \text{max. } 0.2 \text{ mA}$
Diode current commences at . . . . .	$V_{d_1} (I_{d_1} = +0.3 \mu\text{A}) = \text{max. } -0.4 \text{ V}$
Diode current commences at . . . . .	$V_{d_2} (I_{d_2} = +0.3 \mu\text{A}) = \text{max. } -0.7 \text{ V}$

**APPLICATIONS**

The uses of this valve are restricted to diode detection with subsequent R—C coupled, or transformer-coupled A.F. amplification. It is recommended that a grid bias of at least 0.5 V be applied to the grid of the triode, since in some cases grid current commences to flow at  $-0.2 \text{ V}$ . In view of possible microphony, the gain between the diode and triode sections should not exceed a factor of 15.

In the case of series-parallel circuits precautions must be taken as described on p. 82.

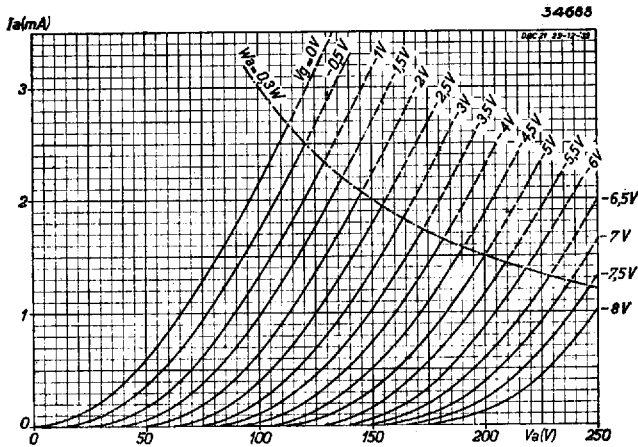

Fig. 5  
Anode current as a function of the anode voltage, with  $V_g$  as parameter.

# DF 21 R.F. Pentode

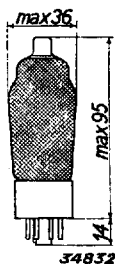

Fig. 1  
Dimensions in mm.

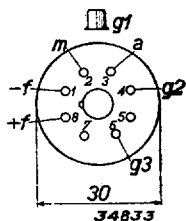
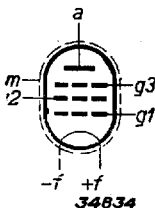

Fig. 2  
Arrangement and sequence of contacts.

The DF 21 is a directly heated pentode with a 1.4 V filament, taking a current of 25 mA. As explained in the Introduction, this extremely low current consumption has been made possible by reducing the thickness of the emissive layer and using high tensile material for the filament, to produce the thinnest possible wire, together with a reduction of the space between the cathode surface and the grid.

The result is a valve which as far as current consumption is concerned is very economical in use and yet has exceptionally good electrical properties. In conjunction with the DK 21, DAC 21, DL 21, this valve enables a receiver to be built of which the total filament current is only 150 mA.

The DF 21 is suitable for R.F., I.F. and A.F. amplification. Although the control grid is of the constant pitch type, the valve, when employed as R.F. or I.F. amplifier, can be controlled by varying the grid bias. It can thus be included in the A.G.C. system, although the cross modulation curve is naturally not so good as in the case of a valve having a variable-pitch grid. Used as resistance-capacitance coupled A.F. amplifier, the DF 21 gives a gain factor of 85. The filament may be series—or parallel—fed and the valve is therefore suitable for use in AC/DC-battery receivers.

### FILAMENT RATINGS

Filament supply: direct, by means of a battery, rectified alternating current or D.C. Series or parallel supply.

Filament voltage . . . . .  $V_f = 1.4$  V

Filament current . . . . .  $I_f = 0.025$  A

### CAPACITANCES

Anode-grid . . . . .  $C_{ag1} < 0.006$  pF

Control grid-all other electrodes. . . . .  $C_{g1} = 5.3$  pF

Anode-all other electrodes . . . . .  $C_a = 7.1$  pF

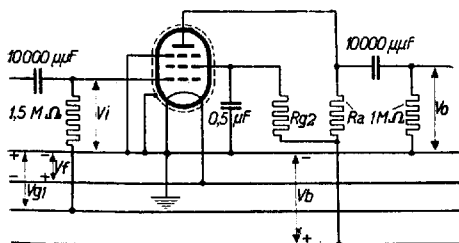

Fig. 3  
Circuit diagram illustrating the symbols employed in the Operating Data



**OPERATING DATA, valve employed as R.F. and I.F. amplifier**

Anode voltage . . . . .	$V_a =$		90 V	
Screen voltage . . . . .	$V_{g2} =$		90 V	
Suppressor grid voltage	$V_{g3} =$		0 V	
Grid bias . . . . .	$V_{g1} = 0 \text{ V}^1)$	$-3.5 \text{ V}^2)$	$-0.5 \text{ V}^1)$	$-3.6 \text{ V}^2)$
Anode current . . . . .	$I_a = 1.2 \text{ mA}$	—	0.85 mA	—
Screen grid current . . .	$I_{g2} = 0.25 \text{ mA}$	—	0.18 mA	—
Mutual conductance . . .	$S = 700$	$7 \mu\text{A/V}$	620	$6.2 \mu\text{A/V}$
Internal resistance . . .	$R_i = 2$	$> 10 \text{ M Ohms}$	3	$> 10 \text{ M Ohms}$
Gain factor in respect of screen grid . . . . .	$\mu_{g2g1} = 30$	—	30	—

**Anode voltage and supply  
voltage to screen grid**

resistance . . . . .	$V_a = V_b =$		120 V	
Suppressor grid voltage	$V_{g3} =$		0 V	
Screen grid resistance . .	$R_{g2} =$		0.12 M Ohms	
Grid bias . . . . .	$V_{g1} = 0 \text{ V}^1)$	$-4.5 \text{ V}^2)$	$-0.5 \text{ V}^1)$	$-4.6 \text{ V}^2)$
Anode current . . . . .	$I_a = 1.2 \text{ mA}$	—	1 mA	—
Screen grid current . . .	$I_{g2} = 0.25 \text{ mA}$	—	0.21 mA	—
Screen grid voltage . . .	$V_{g2} = 90$	120 V	95	120 V
Mutual conductance . . .	$S = 700$	$7 \mu\text{A/V}$	660	$6.6 \mu\text{A/V}$
Internal resistance . . .	$R_i = 2.5$	$> 10 \text{ M Ohms}$	3	$> 10 \text{ M Ohms}$
Gain factor in respect of screen grid . . . . .	$\mu_{g2g1} = 30$	—	30	—

<sup>1)</sup> Valve not controlled.

<sup>2)</sup> Mutual conductance controlled to 1/100.

**OPERATING DATA, valve employed as A.F. amplifier, resistance-capacitance coupled.**

	90 V		120 V	
Battery voltage . . . . .	$V_b =$	90 V		
Anode resistance . . . . .	$R_a = 0.5$	0.2 M Ohms	0.5	0.2 M Ohms
Screen grid resistance . .	$R_{g2} = 2$	1 M Ohm	2	1 M Ohm
Grid bias . . . . .	$V_{g1} = -0.5$	-0.5 V	-0.5	-0.5 V
Anode current . . . . .	$I_a = 0.10$	0.17 mA	0.15	0.28 mA
Screen current . . . . .	$I_{g2} = 0.02$	0.034 mA	0.032	0.056 mA
Required alternating grid voltage for an effective output voltage $V_o \text{ eff}$ $= 3 \text{ V}$ . . . . .	$V_{i \text{ eff}} = 0.043$	0.056 V	0.035	0.044 V
Voltage gain . . . . .	$V_o/V_i = 69$	53	85	68
Total distortion at an alternating output voltage $V_o \text{ eff} = 3 \text{ V}$	$d_{tot} = 1.2$	1.6 %	0.8	0.75 %

**MAXIMUM RATINGS**

Anode voltage . . . . .	$V_a = \text{max. } 135 \text{ V}$
Anode dissipation . . . . .	$W_a = \text{max. } 0.2 \text{ W}$
Screen grid voltage . . . . .	$V_{g2} = \text{max. } 135 \text{ V}$
Screen grid dissipation . . . . .	$W_{g2} = \text{max. } 0.1 \text{ W}$
Cathode current . . . . .	$I_k = \text{max. } 2.5 \text{ mA}$
Grid current commences ( $I_{g1} = +0.3 \mu\text{A}$ ) . . . . .	$V_{g1} = \text{max. } -0.2 \text{ V}$
Max. external resistance between grid and filament . . . . .	$R_{g1f} = \text{max. } 3 \text{ M Ohm}$
Minimum limit of filament voltage . . . . .	$V_f = \text{min. } 1.1 \text{ V}$
Maximum limit of filament voltage . . . . .	$V_f = \text{max. } 1.5 \text{ V}$

**APPLICATIONS**

As already stated, the DF 21 can be used for R.F., I.F. and A.F. amplification. The maximum anode voltage is 120 V and screen voltage 90 V. If the battery voltage is in excess of 90 V it is advisable, when employing the valve as R.F. or I.F. amplifier, to feed the screen through a resistance (sliding screen voltage). If the valve is not controlled, no grid bias is necessary, but at higher screen voltages than 90 V grid bias must be applied to avoid exceeding the values specified for anode and screen dissipation and cathode current.

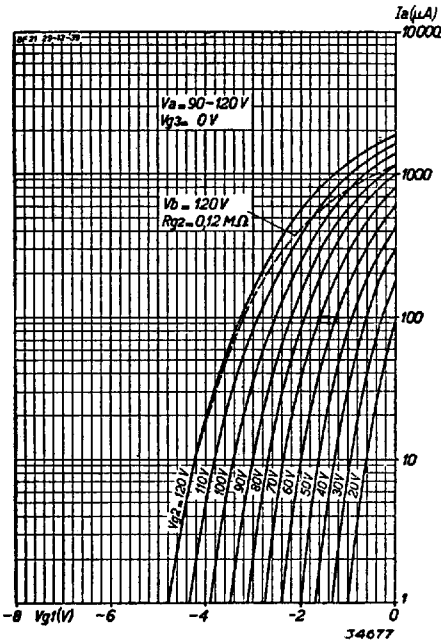

Fig. 4  
Anode current as a function of grid bias at  $V_a = 90 - 120 \text{ V}$ , with  $V_{g2}$  as parameter. The broken line represents the conditions for the controlled valve, with the screen fed from the 120 V source through a resistance of 0.12 M Ohm.

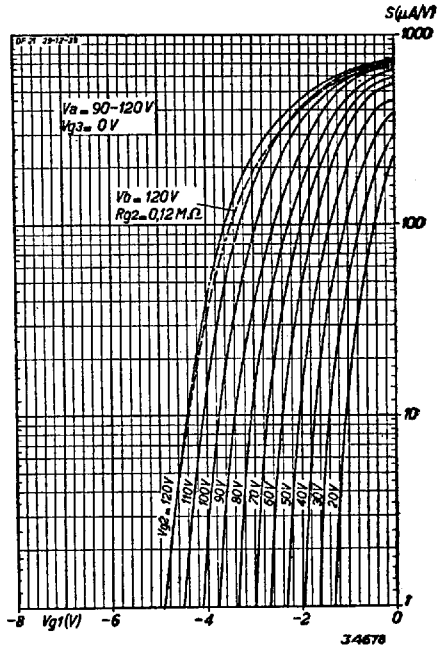

Fig. 5  
Mutual conductance as a function of grid bias, at  $V_a = 90 - 120 \text{ V}$ , with  $V_{g2}$  as parameter. The broken line represents the conditions for the controlled valve, with the screen fed from the 120 V source through a resistance of 0.12 M Ohm.

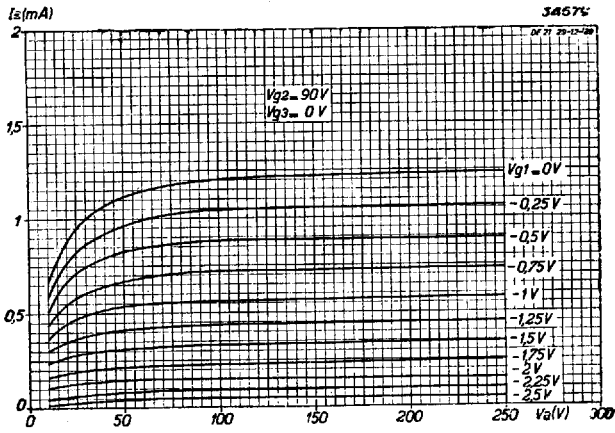

Fig. 6  
Anode current as a function of anode voltage, at  $V_{g_2} = 90$ , with  $V_{g_1}$  as parameter.

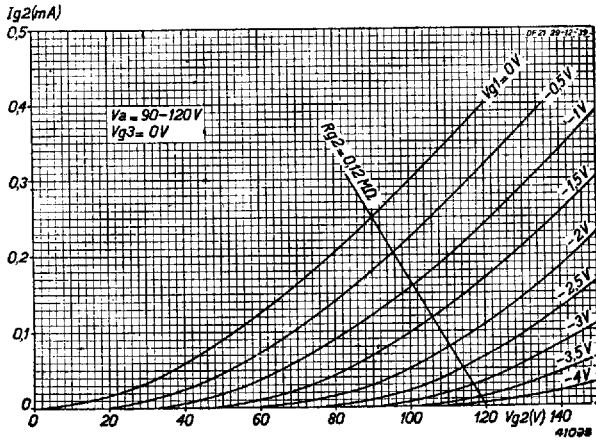

Fig. 7  
Screen current as a function of screen voltage, at  $V_a = 90-120V$ , with  $V_{g_1}$  as parameter.

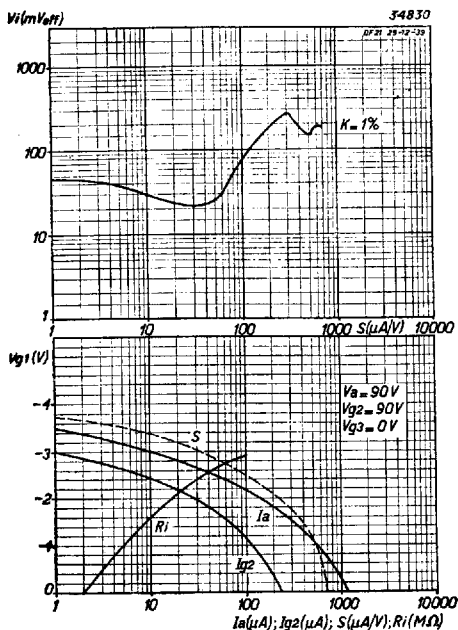

Fig. 8

Upper diagram; Effective value of alternating grid voltage as a function of mutual conductance with 1 % cross modulation, at  $V_a = V_{g_2} = 90$  V.  
 Lower diagram. Mutual conductance  $S$ , anode current  $I_a$ , screen current  $I_{g_2}$ , and internal resistance  $R_i$  as function of grid bias, at  $V_a = V_{g_2} = 90$  V.

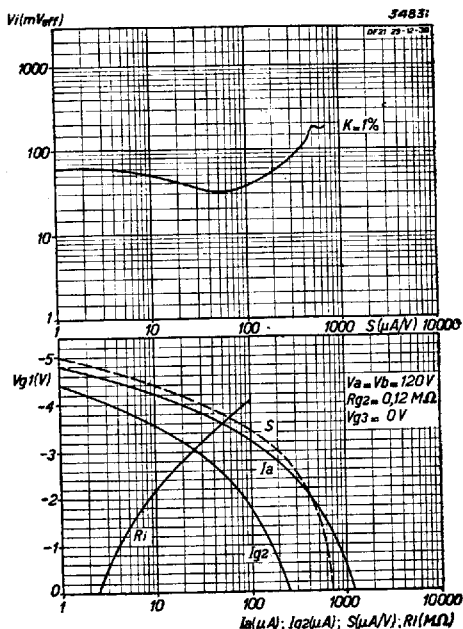

Fig. 9

Upper diagram. Effective value of alternating grid voltage as a function of mutual conductance with 1 % cross modulation, at  $V_a = V_{g_2} = 120$  V.  
 Lower diagram. Mutual conductance  $S$ , anode current  $I_a$ , screen current  $I_{g_2}$ , and internal resistance  $R_i$  as function of grid bias, at  $V_a = V_b = 120$  V.

When the valve is employed as R—C coupled A.F.amplifier, it is necessary that the input voltage, to give an output of 50 mW (sensitivity), be not less than 25 mV, if microphony is to be avoided. Standard precautions have to be taken in the case of series-parallel circuits (p. 82).

It should be noted, further, that although the data supplied with respect to R.F. and I.F.amplification includes a setting of the valve with 0 V grid bias in the uncontrolled condition, the possibility of grid current occurring is not wholly absent (the limit value at which grid current commences to flow is  $-0.2$  V). As a general rule, however, the amount of grid current will be negligible and not give rise to any difficulties, since the DF 21 usually has sufficient grid bias by reason of the A.G.C. The advantage of this setting is that the valve, when not controlled, needs no separate source of grid bias (e.g. from a battery).

# DF 22 variable-mu R.F. Pentode

The DF 22, a directly heated variable-mu R.F. pentode, has a filament voltage of 1.4 V and takes a current of 50 mA. This is double the current required by the DF 21, but on the other hand, the mutual conductance of this valve at  $V_{g1} = -1.5$  V is 1.1 mA/V, as compared with a maximum of 0.7 mA/V in the case of the DF 21.

Due to the variable-pitch grid of the DF 22, the characteristics of this valve are also very much better than those of the DF 21 as regards cross modulation. The minimum point in the cross modulation curve ( $K = 1\%$ ) lies at a mutual conductance of 200  $\mu$ A/V, at which point the permissible alternating voltage of the interfering signal, at 30% modulation, is 55–60 mV (effective). With the DF 21 the minimum occurs at 20  $\mu$ A/V, with an allowable alternating voltage, for 1% cross modulation, of about 20 mV.

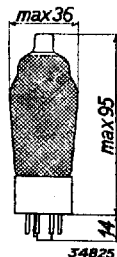

Fig. 1. Dimensions in mm

### FILAMENT RATINGS

Filament supply: direct, from a battery, with rectified A.C., or D.C.  
Series or parallel supply.

Filament voltage . . . . .  $V_f = 1.4$  V

Filament current . . . . .  $I_f = 0.050$  A

### CAPACITANCES

Anode-control grid . . . . .  $C_{ag1} < 0.005$  pF

Control grid-all other electrodes . . . . .  $C_{g1} = 5.0$  pF

Anode-all other electrodes. . . . .  $C_a = 6.8$  pF

### OPERATING DATA: valve employed as R.F. and I.F. amplifier

Anode voltage . . . . .  $V_a = 90$  V

Screen grid voltage . . . . .  $V_{g2} = 90$  V

Suppressor grid voltage . . . . .  $V_{g3} = 0$  V

Grid bias . . . . .  $V_{g1} = -1.5$  V<sup>1)</sup> —  $-6$  V<sup>2)</sup>

Anode current . . . . .  $I_a = 1.4$  mA —

Screen current . . . . .  $I_{g2} = 0.3$  mA —

Mutual conductance . . . . .  $S = 1100$   $\mu$ A/V 11  $\mu$ A/V

Internal resistance . . . . .  $R_i = 1.5$  M Ohms  $> 10$  M Ohms

Gain factor in respect of screen grid . . . . .  $\mu_{g2g1} = 25$  —

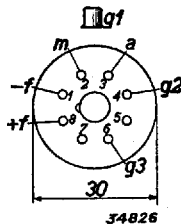
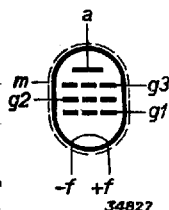

Fig. 2. Arrangement and sequence of contacts.

Anode and supply voltage . . . . .  $V_a = V_b = 120$  V

Screen grid resistance . . . . .  $R_{g2} = 0.1$  M Ohms

Suppressor grid voltage . . . . .  $V_{g3} = 0$  V

Grid bias . . . . .  $V_{g1} = -1.5$  V<sup>1)</sup> —  $-8$  V<sup>2)</sup>

Anode current . . . . .  $I_a = 1.4$  mA —

Screen grid voltage . . . . .  $V_{g2} = 90$  V 120 V

Screen grid current . . . . .  $I_{g2} = 0.3$  mA —

Mutual conductance . . . . .  $S = 1100$   $\mu$ A/V 11  $\mu$ A/V

Internal resistance . . . . .  $R_i = 2.5$  M Ohms  $> 10$  M Ohms

Gain factor in respect of screen . . . . .  $\mu_{g2g1} = 25$  —

<sup>1)</sup> Valve not controlled.

<sup>2)</sup> Mutual conductance controlled to 1/100.

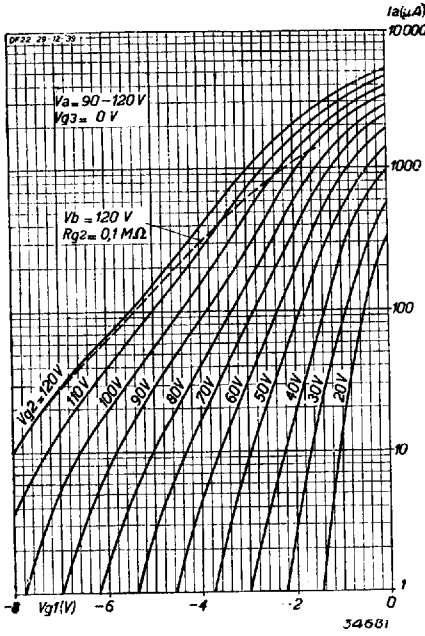

Fig. 3  
Anode current as a function of grid bias, at  $V_a = 90-120 V$ , with  $V_{g_2}$  as parameter. The broken line refers to a valve with control, the screen being fed from the 120 V source through a resistance of 0.1 M Ohm.

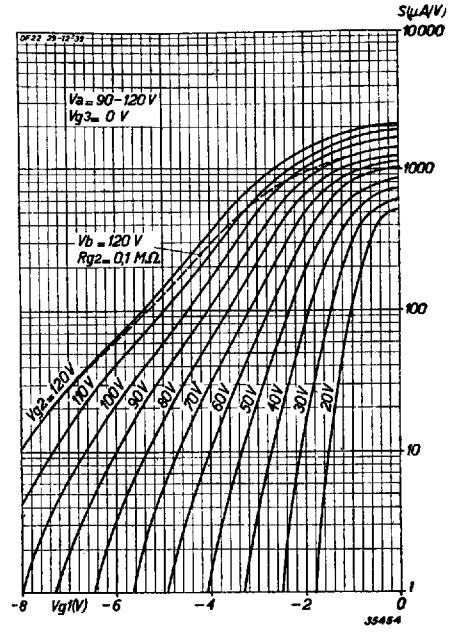

Fig. 4  
Mutual conductance as a function of grid bias, at  $V_a = 90-120 V$ , with  $V_{g_2}$  as parameter. The broken line refers to valve with control, the screen being fed from the 120 V source through a resistance of 0.1 M Ohm.

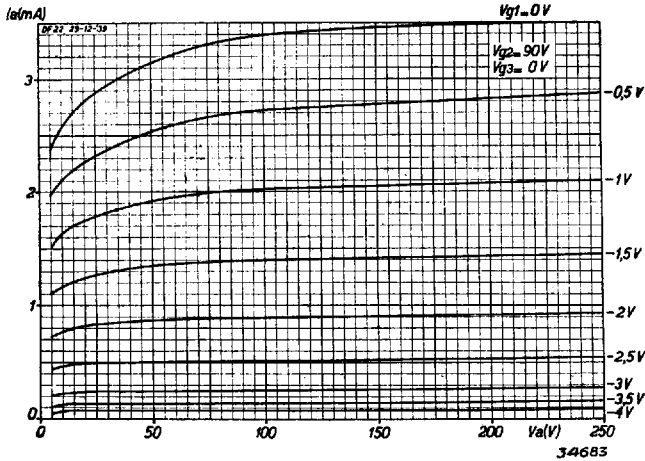

Fig. 5  
Anode current as a function of anode voltage, at  $V_{g_2} = 90 V$ , with  $V_{g_1}$  as parameter.

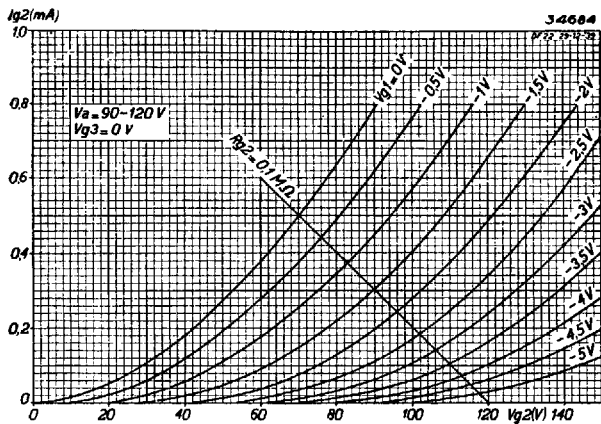

Fig. 6  
Screen grid current as a function of screen voltage at  $V_a = 90 - 120$  V, with  $V_{g1}$  as parameter.

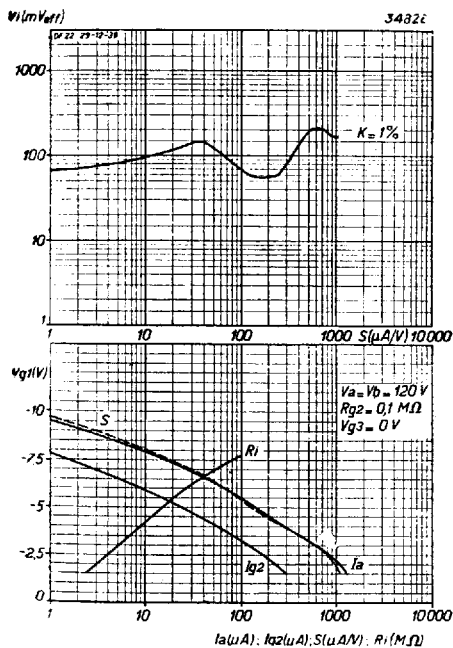

Fig. 7  
Upper diagram; Effective value of alternating grid voltage as a function of mutual conductance, with 1 % cross modulation, at  $V_a = V_b = 120$  V.

Lower diagram; Mutual conductance  $S$ , anode current  $I_a$ , screen current  $I_{g2}$  and internal resistance  $R_i$  as a function of grid bias, at  $V_a = V_b = 120$  V.

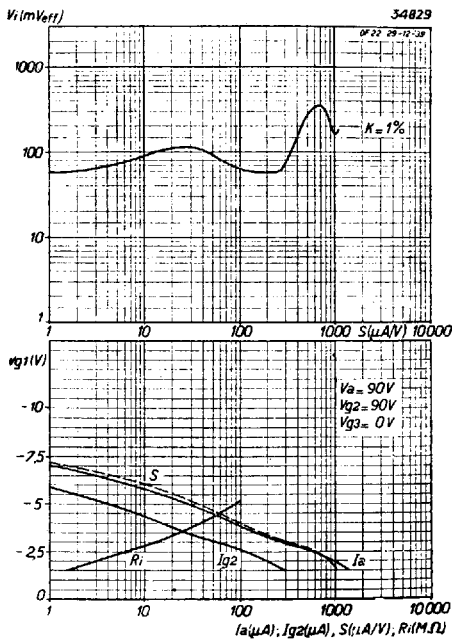

Fig. 8  
Upper diagram; Effective value of alternating grid voltage as a function of mutual conductance, with 1 % cross modulation, at  $V_a = V_{g2} = 90$  V.

Lower diagram; Mutual conductance  $S$ , anode current  $I_a$ , screen current  $I_{g2}$  and internal resistance  $R_i$  as a function of grid bias, at  $V_a = V_{g2} = 90$  V.

**MAXIMUM RATINGS**

Anode voltage . . . . .	$V_a$ = max. 135 V
Anode dissipation . . . . .	$W_a$ = max. 0.2 W
Screen grid voltage . . . . .	$V_{g2}$ = max. 135 V
Screen grid dissipation . . . . .	$W_{g2}$ = max. 0.1 W
Cathode current . . . . .	$I_k$ = max. 3 mA
Grid current commences at ( $I_{g1} = +0.3 \mu A$ ) . . . . .	$V_{g1}$ = max. $-0.2$ V
Max. external resistance between grid 1 and filament . . . . .	$R_{g1f}$ = max. 3 M Ohms
Minimum limit for filament voltage . . . . .	$V_f$ = min. 1.1 V
Maximum limit for filament voltage . . . . .	$V_f$ = max. 1.5 V

The valve can be used for R.F. or I.F. amplification, but, although the screen voltage may certainly be 135 V, the maximum permissible screen dissipation is 0.1 W. If a 120 V H.T. battery is to be used, it is advisable to feed the screen through a resistance of 100,000 Ohms: this will reduce the voltage to 90 V, if no control is applied to the valve. This method of feeding by means of a resistance is simpler than direct feeding by plugging into the 90 V battery-tapping and has the additional advantage that it provides a sliding screen voltage, which is better from the point of view of cross modulation than a fixed potential.

Standard precautions must also be taken in the filament circuit (see p. 82).



# DK 21 Battery Octode

This is a frequency changer for superheterodyne battery receivers designed for use with an octode. It is a directly heated valve with a filament voltage of 1.4 V and is therefore suitable for operation by means of a dry battery. The filament current at the rated voltage is only 50 mA and the filament can be connected in series with other 50 mA valves.

The principle of the DK 21 departs to a certain extent from that of conventional octodes and pentagrids, although the first grid is none the less employed as oscillator grid and the fourth as control grid.

As in the case of the octode EK 3, which works with four electron streams, the DK 21 follows the multi electron-stream system. Fig. 4 shows a cross section through the electrodes, in reference to which the working will now be described.

In the conventional type of octode (e.g. AK 2), the potential in the plane of the control grid is sufficiently positive due to the first positive screen (usually designated  $g_3$ ). In the DK 21, however, the first screen is omitted (see Fig. 4) and its function taken over by the oscillator electrode  $g_2$ , consisting of 4 rods: Figs. 3 and 4 show how these rods are mounted in relation to the first grid; their influence across the first grid is such as to render the emerging electron stream sufficiently strong. The streams flow mainly between the rods to the control grid  $g_4$ , but a small portion arrives directly at the oscillator electrode  $g_2$ . In this way the electron streams are not dispersed by the turns of a screen grid, after the manner of the ordinary octode or heptode (pentagrid):

in other words, the electrons are not deflected in various arbitrary directions, but move in an orderly stream along predetermined paths, and this has a very beneficial effect on the conductance of the 4th grid as also on the conversion conductance of the valve, which is proportional to it.

Assuming that all electrons move towards the 4th grid at the same velocity, at a certain potential in the plane of the 4th grid they will all continue to flow in the direction of the anode. At a slightly lower potential all the electrons will return simultaneously.

This means that the conductance of

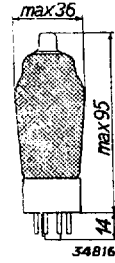

Fig. 1  
Dimensions in mm.

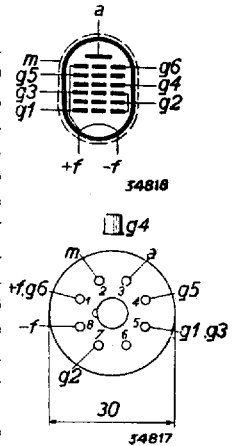

Fig. 2  
Arrangement and  
sequence of con-  
tacts.

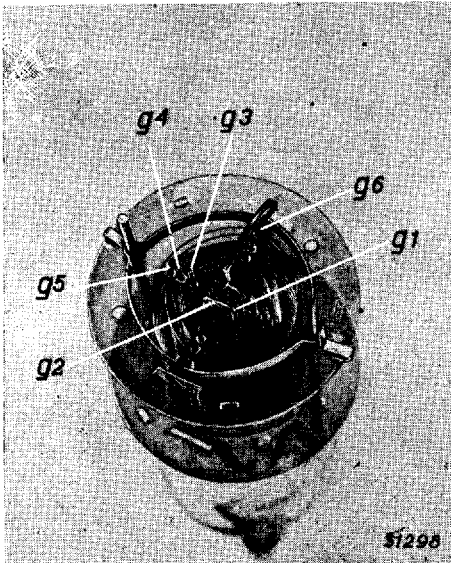
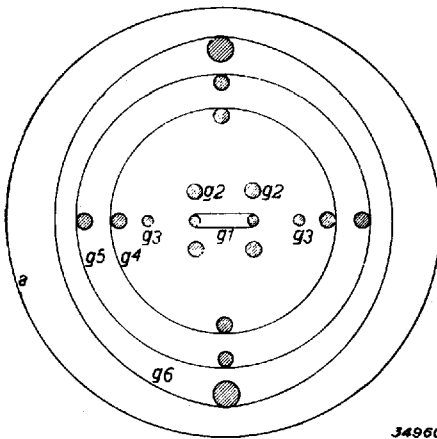

Fig. 3  
Photographic view of interior of the octode DK 21  
(without anode).



34950

Fig. 4  
Diagrammatic cross section through the electrode system of the DK 21.

Most pentodes and heptodes have a screen grid wound in such a way that it produces streams of electrons in the most divergent directions, and the conductance is then so much the lower, but in a valve constructed on the electron-bunching principle, the conductance is very much greater. In the octode having four electron bundles, as mentioned in part II (see p. 106), this electron bunching is carried out by means of slots in the positive screen plates, whereas in the DK 21 the four rods of the oscillator anode serve the same purpose. In this way a mutual conductance of about  $500 \mu\text{A/V}$  is obtained at an anode current of only 1.5 mA, which is twice the figure in respect of the earlier battery octode type KK 2.

The mutual conductance of the oscillator section of the DK 21 is also improved by reason of the special construction, in that electrons that do not pass through the 4th grid pass exclusively to the oscillator anode. In consequence, the whole current is available for purposes of oscillation and it is due to this that the short wave characteristics of the valve are so good at a very low current consumption, although no control is possible in that range.

The principle of the octode, upon which the construction of the DK 21 is based, would involve the disadvantage of inductive effects unless special precautions were taken to prevent this. In the EK 2 and EK 3 the effect is counteracted by inserting

the 4th grid is extremely good. On the other hand, when the electrons are deflected more or less laterally by the turns of a screen grid, not all of them move towards the 4th grid at the same velocity: due to the deflection, velocity in the direction perpendicular to the grid is reduced, whilst the velocity component in the tangential direction is increased. In the DK 21 this latter component, as far as return of the electrons before the grid or their movement towards the anode is concerned, does not play any part at all. If the electrons move at different velocities on their way to the grid, some of them will return from the grid at one voltage and some at another, which considerably reduces the conductance of the 4th grid.

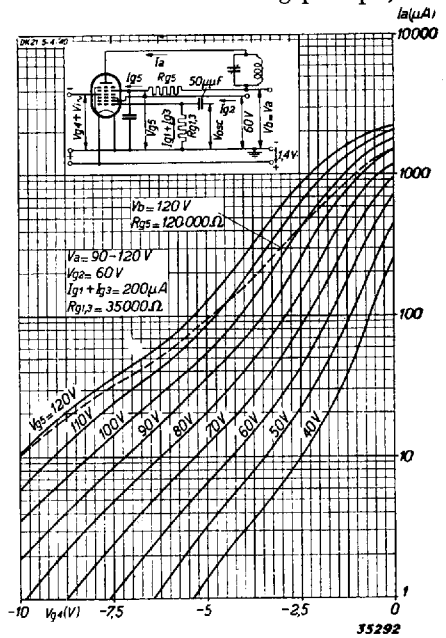

Fig. 5.  
Anode current as a function of grid bias at  $V_a = 90 - 120 \text{ V}$ , with the voltage of grid 5 as parameter. The broken line shows the anode current when the screen is fed from the 120 V source through a resistance of 120,000 Ohms.

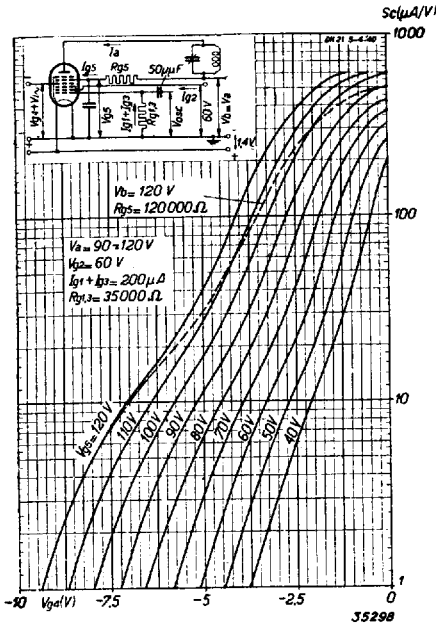

Fig. 6  
Conversion conductance as a function of grid bias at  $V_a = 90 - 120$  V, with the voltage of grid 5 as parameter. The broken line shows the conversion conductance when the screen is fed from the 120 V source through a resistance of 120,000 Ohms.

a condenser, or condenser with resistance, in series between the oscillator and control grids (grids 1 and 4). The compensation is accomplished very simply with the DK 21, in that, close to the supports of the 4th grid, two rods are mounted, in electrical contact with grid 1. In this manner a capacitance is established between grids 1 and 4 which compensates capacitance between the oscillator anode  $g_2$  and grid  $g_4$  as well as that arising from the electronic coupling.

The DK 21 is a variable-mu valve and can therefore be included in the automatic gain control circuit. Since in most battery receivers there is usually only a very small voltage available for the A.G.C., every care has been taken to ensure a sharp control. To regulate the conversion conductance to 1/100 of the initial value the grid bias should be about 8 V. In the short wave range it is not advisable, in view of frequency drift, to control the DK 21, but at wavelengths of upwards of 200 m the drift is sufficiently slight.

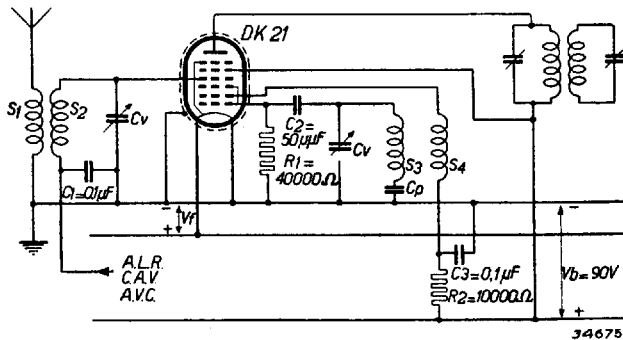

Fig. 7  
Circuit diagram showing the Octode DK 21 employed as frequency-changer.

**FILAMENT RATINGS**

Heating: direct, with battery, rectified alternating current, or D.C.; series or parallel.  
 Filament voltage. . . . .  $V_f = 1.4$  V  
 Filament current. . . . .  $I_f = 0.050$  A

**CAPACITANCES**

Anode-control grid . . . . .	$C_{ag4}$	< 0.1 pF
Anode capacitance . . . . .	$C_a$	= 9.4 pF
Control grid capacitance . . . . .	$C_{g4}$	= 9.2 pF
Oscillator grid capacitance . . . . .	$C_{(g1+g3)}$	= 7.0 pF
Oscillator anode capacitance . . . . .	$C_{g2}$	= 5.9 pF
Oscillator anode-control grid . . . . .	$C_{g2g4}$	< 0.9 pF
Oscillator grid-control grid . . . . .	$C_{(g1+g3)g4}$	= 1.3 pF

**OPERATION DATA FOR THE MIXER SECTION**

**a) at 90 V and with fixed screen grid voltage**

Supply or anode voltage. . . . .	$V_b = V_a =$	90 V
Screen grid voltage . . . . .	$V_{g5} =$	90 V
Oscillator grid leak . . . . .	$R_{g1,3} =$	35,000 Ohms
Oscillator anode resistance . . . . .	$R_{g2} =$	12,500 Ohms
Current flow through grid leak of oscillator during oscillation. . . . .	$I_{g1+I_{g3}} =$	200 $\mu$ A
Grid bias. . . . .	$V_{g4} =$	0 V <sup>1)</sup> —6 V <sup>2)</sup>
Oscillator anode voltage . . . . .	$V_{g2} =$	60 V —
Anode current . . . . .	$I_a =$	1.5 mA —
Oscillator anode current . . . . .	$I_{g2} =$	2.4 mA —
Screen grid current . . . . .	$I_{g5} =$	0.25 mA —
Conversion conductance . . . . .	$S_c =$	500 $\mu$ A/V 5 $\mu$ A/V
Internal resistance . . . . .	$R_i =$	1.25 M Ohms > 10 M Ohms

**b) at 120 V and with sliding screen grid voltage**

Screen supply or anode voltage . . . . .	$V_a = V_b =$	120 V
Screen grid resistance . . . . .	$R_{g5} =$	120,000 Ohms
Oscillator grid leak . . . . .	$R_{g1,3} =$	35,000 Ohms
Oscillator anode grid resistance . . . . .	$R_{g2} =$	25,000 Ohms
Current flow through grid leak of the oscillator during oscillation. . . . .	$I_{g1+I_{g3}} =$	200 $\mu$ A
Grid bias. . . . .	$V_{g4} =$	0 V <sup>1)</sup> —8 V <sup>2)</sup>
Oscillator anode voltage . . . . .	$V_{g2} =$	60 V —
Anode current . . . . .	$I_a =$	1.5 mA —
Oscillator anode current . . . . .	$I_{g2} =$	2.4 mA —
Screen grid current . . . . .	$I_{g5} =$	0.25 mA —
Screen voltage . . . . .	$V_{g5} =$	90 V 120 V
Conversion conductance . . . . .	$S_c =$	500 $\mu$ A/V 5 $\mu$ A/V
Internal resistance . . . . .	$R_i =$	1.5 M Ohms > 10 M Ohms

<sup>1)</sup> Valve not controlled.  
<sup>2)</sup> Conversion conductance controlled to 1/100.

**RATINGS AND OPERATING DATA FOR THE OSCILLATOR SECTION**

Supply voltage . . . . .	$V_b$	=	90 V	120 V
Oscillator anode resistance . . . . .	$R_{g2}$	=	12,600 Ohms	25,000 Ohms
Oscillator anode voltage during oscillation . . . . .	$V_{g2}$	=	60 V	60 V
Oscillator grid leak . . . . .	$R_{g1,3}$	=	35,000 Ohms	35,000 Ohms
Current flow through grid leak of the oscillator to give the required oscillating voltage. . . . .	$I_{g1} + I_{g3}$	=	200 $\mu$ A	200 $\mu$ A
Oscillator anode current during oscillation	$I_{g2}$	=	2.4 mA	2.4 mA
Oscillator anode current, quiescent ( $V_{osc} = 0$ V; $V_{g2} = 60$ V) . . . . .	$I_{g2}$	=	—	3.1 mA
Mutual conductance at commencement of oscillation ( $V_{osc} = 0$ V; $I_{g2} = 3.1$ mA)	$S_{g2g1}$	=	—	0.95 mA/V
Gain factor ( $V_{osc} = 0$ V; $I_{g2} = 3.1$ mA)	$\mu_{g2g1}$	=	—	8.5

**MAXIMUM RATINGS**

Anode voltage . . . . .	$V_a$	=	max. 135 V
Anode dissipation . . . . .	$W_a$	=	max. 0.3 W
Screen grid voltage . . . . .	$V_{g5}$	=	max. 135 V
Screen grid dissipation. . . . .	$W_{g5}$	=	max. 0.05 W
Oscillator anode voltage . . . . .	$V_{g2}$	=	max. 80 V
Oscillator anode dissipation . . . . .	$W_{g2}$	=	max. 0.3 W
Cathode current. . . . .	$I_k$	=	max. 5 mA
Grid current commences at ( $I_{g4} = +0.3$ $\mu$ A) . . . . .	$V_{g4}$	=	max. +0.2 V
Max. external resistance between grid 4 and filament . . . . .	$R_{g4f}$	=	max. 3 M Ohms
Max. external resistance between grid 1 + 3 and filament . . . . .	$R_{g1,3f}$	=	max. 0.1 M Ohm
Minimum limit for the filament voltage. . . . .	$V_f$	=	min. 1.1 V
Maximum limit for the filament voltage . . . . .	$V_f$	=	max. 1.5 V

**APPLICATIONS**

The DK 21 was expressly designed for use as frequency-changer in battery super-heterodyne receivers and more especially for sets in which the filament current is to be as low as possible. The H.T. battery may be between 90 and 135 V and filament voltage is taken from a dry battery, or an accumulator with resistance in series. This valve will still work in conventional circuits when the H.T. voltage has dropped from 90 to 60 V and the filament voltage to 1.1 V, although, naturally, the conversion conductance is then considerably less.

The external circuit of the DK 21 is extremely simple and Fig. 7 shows the arrangement for use as frequency changer. It is advisable to couple the tuned oscillator circuit to the first grid and to feed back by way of the oscillator anode, since this is the only method of obtaining reliable oscillation when normal types of coil are used. To ensure stable oscillation, the oscillator anode should be connected to the HT battery through a series resistance and not direct to one of the battery tappings. Due to the constructional details mentioned above, the inductance effect is negligibly small (max. induced voltage about 0.4 V), and the consequent effect upon the conductance in normal circuits is barely perceptible.

It is recommended that the positive side of the voltage be connected to pin No. 1 (see Fig. 2), with which the suppressor grid is also in contact: this gives a higher conversion conductance than in the opposite case. Finally, it should be noted that grid current commences to flow only when the control grid carries a small positive potential, so that no grid bias need be applied to this grid.

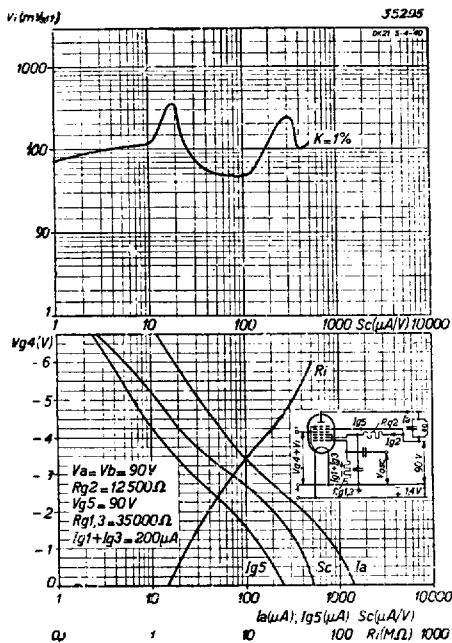

Fig. 8  
 Upper diagram; Alternating grid voltage at 1% cross modulation, as function of conversion conductance at  $V_a = V_b = V_{g5} = 90V$ .  
 Lower diagram; conversion conductance  $Sc$ , anode current  $I_a$ , screen current  $I_{g5}$  and internal resistance  $R_i$  as a function of grid bias.

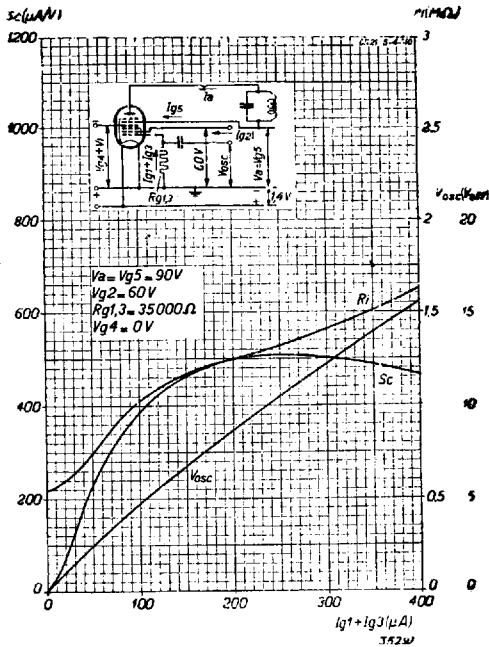

Fig. 9  
 Conversion conductance  $Sc$ , internal resistance  $R_i$ , and alternating oscillator voltage  $V_{osc}$  (effective) as a function of oscillator grid current  $I_{g1} + I_{g3}$ , at  $V_a = V_{g5} = 90V$ .

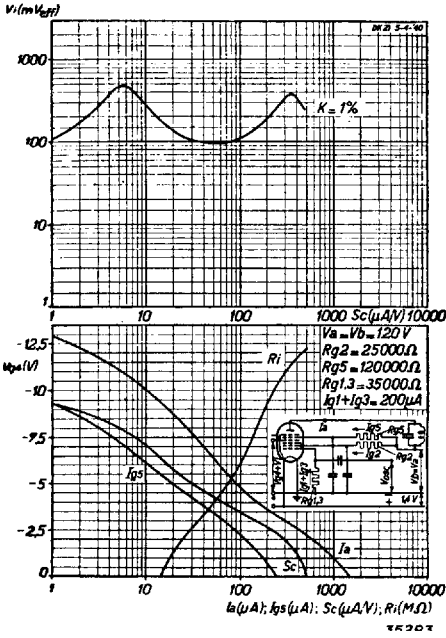

Fig. 10

Upper diagram: Alternating grid voltage with 1% cross modulation, as a function of conversion conductance, at  $V_a = V_b = 120$  V. Lower diagram: Conversion conductance  $Sc$ , anode current  $I_a$ , screen grid current  $I_{g5}$ , and internal resistance  $Ri$  as a function of grid bias.

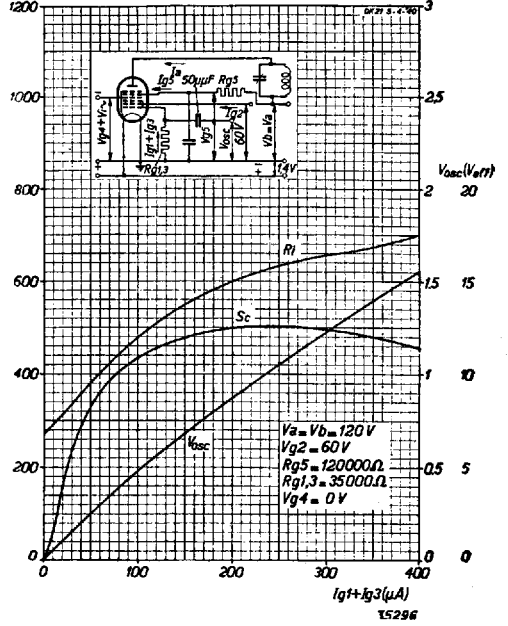

Fig. 11

Conversion conductance  $Sc$ , internal resistance  $Ri$  and alternating oscillator voltage  $V_{osc}$  (effective value), as function of oscillator grid current  $I_{g1} + I_{g3}$ , at  $V_a = V_b = 120$  V

# DL 21 Output pentode

This is an output pentode for battery sets, operating on a filament voltage of 1.4 V. The output power which this valve is capable of supplying is large, taking into consideration the fact that when economical feeding from a dry battery is employed only a very small amount of filament power is available. The sensitivity of the DL 21 is very good: on a filament current of only 50 mA and an anode voltage of 90 V, the output power is 170 mW at an anode current of only 4 mA (10 % distortion). The efficiency (47 %) may thus be regarded as excellent, especially when it is remembered that it is much more difficult to attain satisfactory efficiency in low-current valves than with larger, mains-operated output valves. The output power of 170 mW is naturally a compromise between the rating of the available batteries, their life and the desired volume of sound and this compromise is admirably met by the particular construction of the valve. At a higher anode voltage the DL 21 will supply a greater amount of power; at 120 V, on an anode current of 5 mA, the output is 270 mW (10 % distortion). The screen current is very low and for practical purposes may be ignored; the efficiency, then, remains on the high side (40 %). The sensitivity (for  $W_o = 50$  mW) is 1.0—1.1 V.

An advantage of the low filament current of 50 mA is that it enables economical receivers to be designed, with the filaments of the valves

connected in series. The current in the filament circuit is determined by the valve taking the most current (usually the output valve) and 50 mA circuits can therefore be employed with the DL 21, since the preceding valves can be selected from the same series of 1.4 V battery types, having this same current of 50 mA or even less (25 mA). The filament of the DL 21 may be connected either in series or in parallel with the other valves (for example in AC/DC-battery sets). To avoid anode ripple, the DL 21 should be connected to the negative end of the filament circuit when series-coupled. With a view to heating the filament from a dry battery, with consequent voltage-drop during the life of the latter, the valve has been specially constructed to be relatively insensitive to under-heating.

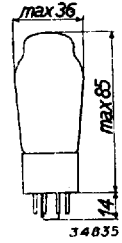

Fig. 1  
Dimensions in mm.

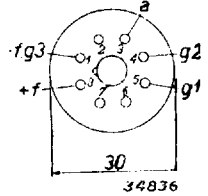
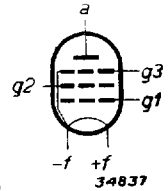

Fig. 2.  
Arrangement and  
sequence of  
contacts.

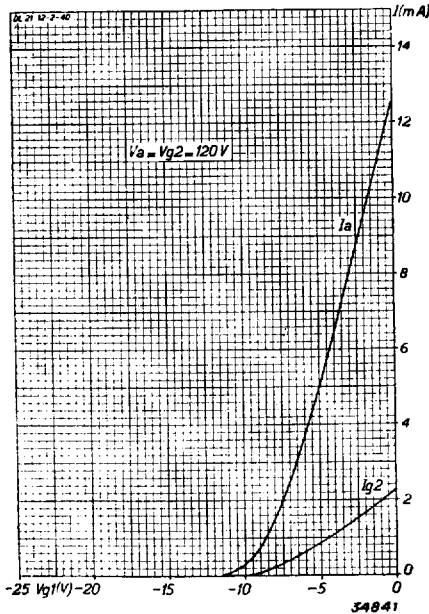

Fig. 3  
Anode and screen current as a function of the  
grid bias at  $V_a = V_{g_2} = 120$  V.



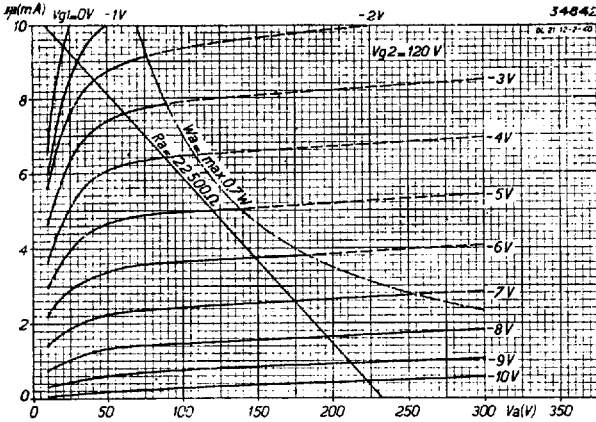

Fig. 4  
Anode current as a function of the anode voltage at  $V_{g2} = 120$  V, with  $V_{g1}$  as parameter.

**FILAMENT RATINGS**

Heating: direct, with battery, rectified A.C., or direct current, series or parallel feed.  
 Filament voltage. . . . .  $V_f = 1.4$  A  
 Filament current. . . . .  $I_f = 0.050$  A  
 Capacity anode - control grid . . . . .  $C_{ag1} = \text{max. } 0.5$  pF

**OPERATING DATA: valve employed as single output valve**

Anode voltage . . . . .	$V_a = 90$ V	120 V
Screen grid voltage . . . . .	$V_{g2} = 90$ V	120 V
Grid bias . . . . .	$V_{g1} = -3.0$ V	-4.8 V
Anode current . . . . .	$I_a = 4$ mA	5 mA
Screen grid current . . . . .	$I_{g2} = 0.7$ mA	0.9 mA
Mutual conductance . . . . .	$S = 1.3$ mA/V	1.4 mA/V
Internal resistance . . . . .	$R_i = 0.3$ M Ohm	0.35 M Ohm
Optimum value of matching resistance	$R_a = 22,500$ Ohms	24,000 Ohms
Output power . . . . .	$W_o = 165$ mW	270 mW
Total distortion . . . . .	$d_{tot} = 10$ %	10 %
Required alternating grid voltage . . .	$V_{ieff} = 2.1$ V	3.2 V
Sensitivity . . . . .	$V_{ieff} (W_o = 50 \text{ mW}) = 1.1$ V	1.0 V

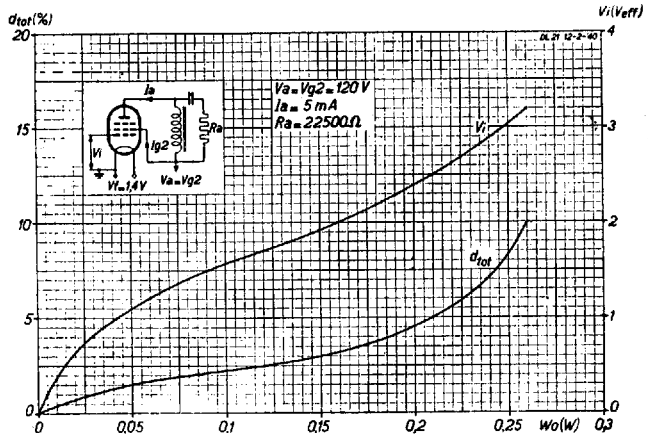

Fig. 5  
Total distortion and required alternating grid voltage as function of output power at  $V_a = V_{g2} = 120$  V.

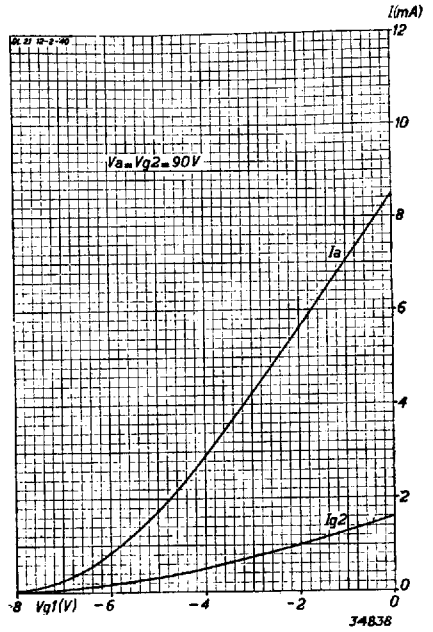

Fig. 6  
Anode and screen current as a function of grid bias at  $V_a = V_{g2} = 90$  V.

**MAXIMUM RATINGS**

Anode voltage . . . . .	$V_a = \text{max. } 135 \text{ V}$
Anode dissipation . . . . .	$W_a = \text{max. } 0.7 \text{ W}$
Screen grid voltage . . . . .	$V_{g2} = \text{max. } 135 \text{ V}$
Screen grid dissipation . . . . .	$W_{g2} = \text{max. } 0.2 \text{ W}$
Cathode current . . . . .	$I_k = \text{max. } 7 \text{ mA}$
Grid current commences at ( $I_{g1} = +0.3 \mu\text{A}$ ). . . . .	$V_{g1} = \text{max. } -0.2 \text{ V}$
Max. external resistance between grid 1 and filament . . . . .	$R_{g1f} = \text{max. } 2 \text{ M Ohms}$
Minimum limit for filament voltage . . . . .	$V_f = \text{min. } 1.1 \text{ V}$
Maximum limit for filament voltage . . . . .	$V_f = \text{max. } 1.5 \text{ V}$

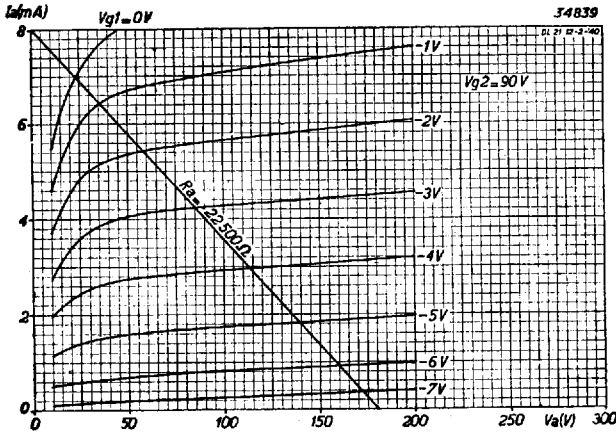

Fig. 7  
Anode current as a function of anode voltage at  $V_{g2} = 90$  V, with  $V_{g1}$  as parameter.

## APPLICATIONS

The DL 21 is intended as output valve for battery receivers working with a very low filament current and giving a comparatively high output. For receivers which are required to give higher output power, the double pentode DLL 21 should be used. The value of the grid leak must not be in excess of 2 Megohms and grid bias should for preference be supplied by means of a resistance between the negative side of the filament vol-

tage and the negative terminal of the H.T. battery. In the case of a fixed bias, the grid leak may not be greater than 1 Megohm. As explained at the commencement of this section, the very low filament current of the valves in this D-series, as compared with that of the K-type, is due to the use of an extremely thin filament wire, and the reduction in the thickness in some cases necessitates special precautions against possible damage to the filament: such precautions will now be explained in reference to Fig. 9.

Before the anode and filament voltages are switched on, the potential between the grid and filament of the output valve will be equal to  $V_g$ ; in circuits in which grid bias is obtained in a manner other than that indicated it is then zero, or, at any rate, very small indeed. As soon as the voltage is switched on, a voltage surge,  $+V_a$ , occurs however at the grid of the output valve across  $R_1$  and  $C$ . Usually  $R_1$  is low as compared with  $R_2$ , so that, at the first moment, practically the whole anode voltage  $V_a$  occurs at the grid. Condenser  $C$  then gradually charges across  $R_2$  and ultimately absorbs the whole voltage  $V_a$ , with the result that the grid is restored to its initial potential ( $V_g$ ). The curve in respect of this voltage at the grid of the output valve is shown in Fig. 10 as a function of the time, for the conditions where  $C = 5000$  pF and  $R_2 = 1$  Megohm. Although the duration of the excess voltage is only quite short (of the order of 0.01 seconds), it is nevertheless sufficient to cause a flashover which is immediately followed

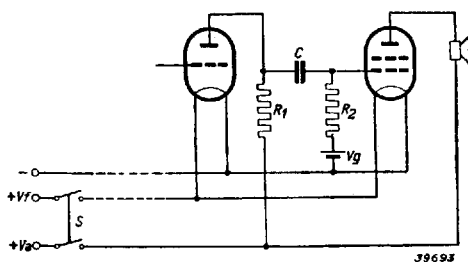

Fig. 9  
Circuit diagram of the A.F. section of a battery receiver.

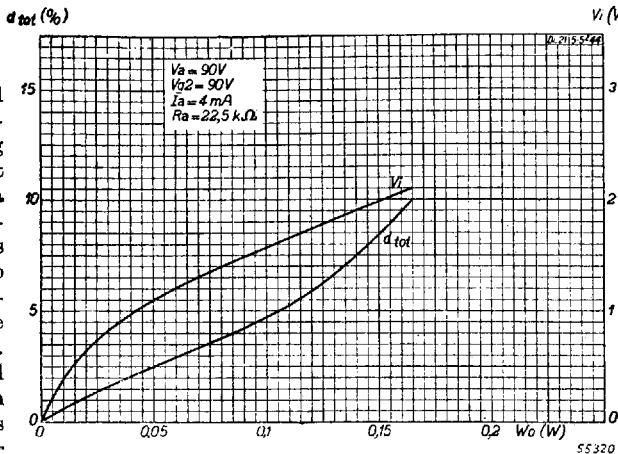

Fig. 8  
Total distortion and required alternating grid voltage as a function of output power at  $V_a = V_{g_2} = 90$  V.

by an even greater discharge in the anode circuit, and the very thin filament is, generally speaking, unable to withstand such discharges. At the same time, if the same voltage be applied to the "cold" valve the flashover will not occur. It may be concluded that despite the warming up period of about 0.01 seconds the temperature of the filament is increased very considerably in a very much shorter time.

This phenomenon can be avoided in

several ways, the simplest method being to bridge the switch in the anode circuit with a resistance of some Megohms: the anode voltage will then be already applied to the valve when the filament current is switched on and, when the resistance is shorted out by the closing of the switch, no further voltage surges are possible.

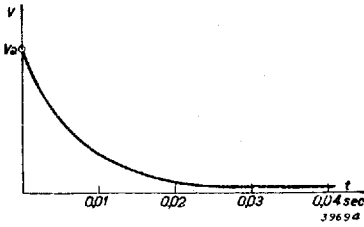

Fig. 10  
Voltage on the grid of the output valve as a function of charging time of the grid condenser  $C$  in Fig. 9.

Moreover, if for any reason a short circuit should occur in the receiver when not in use, the resistance across the switch will sufficiently limit the anode current.

If, however, a potentiometer is fitted on the other side of the switch, between the positive and negative anode leads, the method of protection described in the foregoing cannot be adopted, but this will not often be the case, since battery operated receivers to limit anode current do not usually include a potentiometer. Nevertheless, if a potentiometer is provided, one solution is to fit a double-pole switch, so arranged

that anode and filament voltage are not switched on simultaneously. Fig. 10 shows that it is only necessary to close the switch for the anode voltage some hundredths of a second before applying the filament voltage, in order to avoid surges.

Another method is to smooth the anode voltage of the penultimate valve by means of a resistance and relatively large condenser, so that the surge occurring at  $R_1$  takes place very slowly when the set is switched on, and is reproduced only very weakly by the condenser  $C$ . The time-constant of this smoothing circuit should therefore be high in comparison with that of  $R_2-C$ , the method necessarily involving use of an extra condenser and resistance.

Finally, it should be noted that the phenomenon in question can also take place in other than output stages, in fact in every case where the valve is coupled capacitively to the anode of the preceding valve, but as far as these other valves are concerned the consequences are always less serious, in view of the lower anode voltages involved.

# DLL 21 Double output pentode

In many instances the output stage of a battery receiver, especially where a fairly large output is required, will consist of two triodes or pentodes or, alternatively, a double triode or pentode in a push-pull circuit: in order to keep the anode current as low as possible, the circuit is then usually of the Class B type.

As far as the possible saving in current is concerned, it is immaterial whether two triodes or two pentodes are employed, and it is of no more importance whether two separate valves or two valve-systems in a common envelope are used; the ultimate choice between two individual pentodes or triodes, or two such valves in one, is governed by the requirements laid down in respect of quality of reproduction and filament current consumption, as well as by considerations affecting the layout of the receiver.

If the advantages and disadvantages of individual or double triodes or pentodes are weighed up, these may be summarised as follows:

### Advantages of an output stage with two triodes or a double triode

- 1a) When two triodes are used, or one double triode, it is usual to select a type of valve that requires no grid bias in Class B circuits. The full battery voltage is then available for the anode, and two triodes therefore give a slightly greater output.
- 2a) The absence of screen grid feed and grid bias tends to simplify construction of the receiver.
- 3a) A triode, or a double triode, is a simpler valve than a pentode or double pentode.

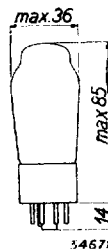

Fig. 1  
Dimensions in mm.

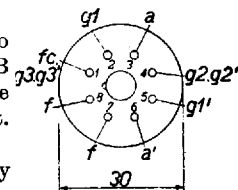
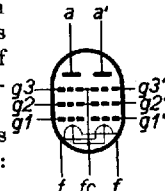

Fig. 2  
Arrangement and sequence of contacts.

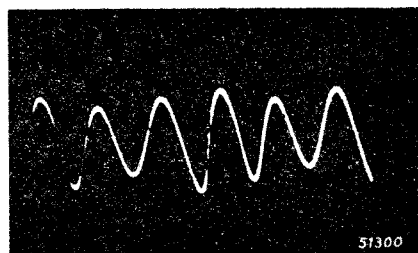
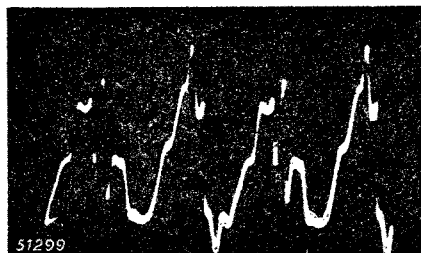

Fig. 3

a. Oscillogram showing the distortion occurring in a Class B output stage of two triodes in which grid current is flowing.

b. Oscillogram showing the distortion occurring in an output stage of 2 pentodes without grid current. It will be seen that the distortion is caused almost exclusively by the third harmonic.

In both oscillograms the fundamental frequency has been filtered out.

### Disadvantages of an output stage with two triodes or a double triode

- 1b) Since the anode voltage available in a battery set is on the low side, it is not possible to obtain satisfactory efficiency when it is stipulated that the valve must

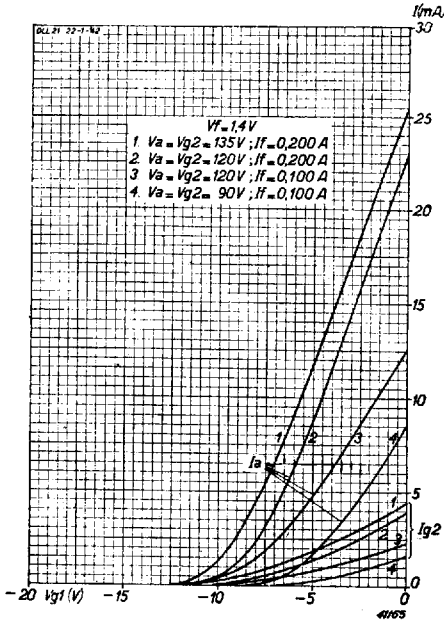

Fig. 4  
Anode and screen current of one pentode section of the DLL 21 as a function of the grid bias at  $V_f = 1.4$  V, in respect of different values of anode and screen voltage and filament current.

From these considerations the following conclusions may be drawn:  
If the filament current of a receiver does not need to meet very stringent requirements, as when supplied by an accumulator, the choice between triodes and pentodes is governed firstly by the required quality of reproduction.

Since quality is not such an important factor in the cheaper types of receiver, however, it will often be preferable to employ triodes for the output stage, in order to simplify construction. On the other hand, if high quality reproduction is demanded the pentode is normally given preference. The K-series of valves, designed in the first place for accumulator feeding, includes therefore a double triode: there

not run into grid current. When triodes are employed the valve must therefore be modulated in the region of positive grid current, which, even when a driver stage is included, generally leads to distortion. The distortion in an output stage comprising two triodes running into grid current, as well as that of a stage consisting of two pentodes without grid current, may be ascertained from the oscillograms shown in Figs. 3a and b. In both these oscillograms the fundamental frequency has been filtered out, in order to give a true picture of the actual distortion. Whereas in the case of the two pentodes the distortion is almost wholly due to the 3rd harmonic, much higher harmonics occur in the case of the two triodes with grid current.

- 2b) With a double triode, driver stage must be employed to supply the grid current for the output stage and, since the object of this stage is to provide power, it is usual to use a valve operating on a relatively high filament current.
- 3b) The last stages must consist of two valves, a driver and an output valve.

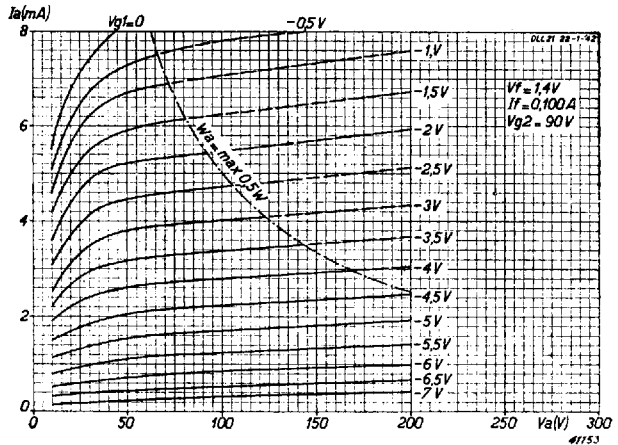

Fig. 5  
Anode current of one of the sections of the DLL 21 as a function of the anode voltage, at  $V_{g2} = 90$  V,  $V_f = 1.4$  V and  $I_f = 100$  mA, with  $V_{g1}$  as parameter.

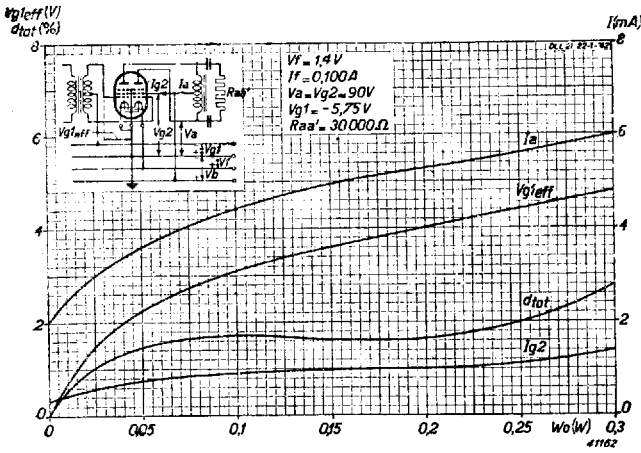

Fig. 6

Total anode current and screen current, total distortion and required alternating grid voltage per grid as function of output power of the DLL 21 used as Class B amplifier at  $V_b = V_a = V_{g_2} = 90$  V;  $V_f = 1.4$  V and  $I_f = 100$  mA.

would be room for a double pentode for quality receivers, but since in this class of receiver it is not so necessary to limit the number of valves there is no reason why two separate pentodes cannot be used. When dry batteries are used the situation is, however, very different, as a saving in filament current is then of the first importance. The 1.4 V range of valves has therefore been made to include a double pentode for use in low-priced sets, so that this range offers both a single

and a double pentode, but no double triode. The double pentode is the DLL 21, each half-section of which has two filaments, the arrangement of the contact pins being such (see Fig. 2) that either one or both filaments can be employed, as demanded by circumstances; it is thus possible to feed the filament in the following different ways:

- A. feed voltage 1.4 V, current 100 mA,
- B. feed voltage 1.4 V, current 200 mA,
- C. feed voltage 2.8 V, current 100 mA.

The last mentioned method of wiring is of especial importance in connection with the application of the valve in AC/DC-battery receivers.

When the filament is connected as in A) (100 mA, on 1.4 V), the valve delivers 300 mW at an anode and screen voltage of 90 V, the distortion in that case being 2.8 %. At an anode and screen voltage of 120 V the output is 600 mW at 3 % distortion. The required alternating grid voltage is extremely low, with consequent low distortion also in the preceding stage; at 90 V the voltage in question is 4.8 V per grid and at 120 V only 6.8 V.

With the filament connected as in B) or C) (200 mA at 1.4 V and 100 mA at 2.8 V respectively), the output power is 1.2 W at an anode and screen voltage of 120 V, or 1.5 W at 135 V.

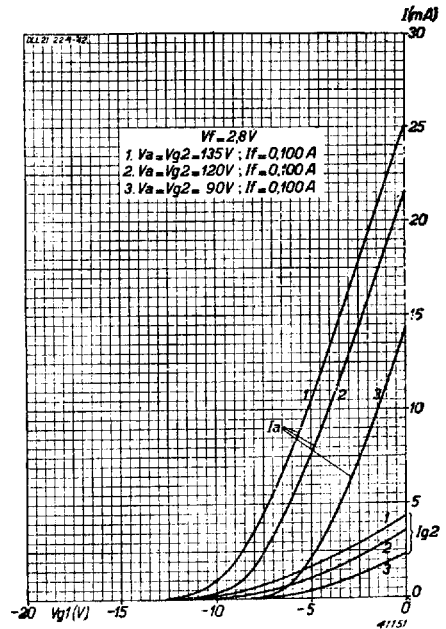

Fig. 7

Anode and screen grid current of one pentode section as function of grid bias at  $V_a = V_{g_2} = 90$  V, 120 V and 135 V,  $V_f = 2.8$  V and  $I_f = 100$  mA.

**FILAMENT RATINGS**

Heating: direct from a battery, rectified A.C. or direct current: series or parallel.

Filament voltage ( $f_c, g_3, g_3'/f$ ) . . . . .  $V_f = 1.4$  V

Filament current. . . . .  $I_f = 0.100$  A

or

Filament voltage ( $f_c, g_3, g_3'/f, f$ ) . . . . .  $V_f = 1.4$  V

Filament current. . . . .  $I_f = 0.200$  A

or

Filament voltage ( $f/f$ ) . . . . .  $V_f = 2.8$  V

Filament current. . . . .  $I_f = 0.100$  A

**CAPACITANCES**

Anode—grid . . . . .  $C_{ag1} < 0.6$  pF

Anode—grid . . . . .  $C_{a'g1'} < 0.6$  pF

**OPERATING DATA: valve employed as Class B amplifier**

Filament voltage . . . . .	$V_f$	=	1.4 V
Filament current . . . . .	$I_f$	=	0.100 A
Anode voltage . . . . .	$V_a$	=	90 V      120 V
Screen grid voltage . . . . .	$V_{g2}$	=	90 V      120 V
Grid bias . . . . .	$V_{g1}$	=	-5.7 V      -8.7 V
Standing anode current . . . . .	$I_{a0}$	=	$2 \times 1$ mA $2 \times 1$ mA
Anode current at max. modulation . . . . .	$I_{a\ max}$	=	$2 \times 3.0$ mA $2 \times 4.15$ mA
Standing screen current . . . . .	$I_{g20}$	=	$2 \times 0.16$ mA $2 \times 0.16$ mA
Screen current at max. modulation . . . . .	$I_{g2\ max}$	=	$2 \times 0.7$ mA $2 \times 1.1$ mA
Optimum value of matching resistance (between anodes) . . . . .	$R_{aa'}$	=	30,000 Ohms      30,000 Ohms
Output power at max. modul. . . . .	$W_o$	=	0.3 W      0.6 W
Total distortion . . . . .	$d_{tot}$	=	2.8 %      3 %
Required alternating grid voltage per grid	$V_{g1(eff)}$	=	4.8 V      6.8 V

Filament voltage . . . . .	$V_f$	=	1.4 V
Filament current . . . . .	$I_f$	=	0.200 A
Anode voltage . . . . .	$V_a$	=	120 V      135 V
Screen grid voltage . . . . .	$V_{g2}$	=	120 V      135 V
Grid bias . . . . .	$V_{g1}$	=	-8.2 V      -9.4 V
Standing anode current . . . . .	$I_{a0}$	=	$2 \times 2$ mA $2 \times 2$ mA
Anode current at max. modulation . . . . .	$I_{a\ max}$	=	$2 \times 7.5$ mA $2 \times 8.8$ mA
Standing screen current . . . . .	$I_{g20}$	=	$2 \times 0.35$ mA $2 \times 0.35$ mA
Screen current at max. modulation . . . . .	$I_{g2\ max}$	=	$2 \times 2$ mA $2 \times 2.3$ mA
Optimum value of matching resistance (between anodes) . . . . .	$R_{aa'}$	=	15,000 Ohms      15,000 Ohms
Output power at max. modulation . . . . .	$W_o$	=	1.2 W      1.5 W
Total distortion . . . . .	$d_{tot}$	=	5 %      3.8 %
Required alternating grid voltage . . . . .	$V_{g1(eff)}$	=	7.0 V      7.6 V



Filament voltage . . . . .	$V_f$	=	2.8 V		
Filament current . . . . .	$I_f$	=	0.100 A		
Anode voltage . . . . .	$V_a$	=	90 V	120 V	135 V
Screen voltage . . . . .	$V_{g2}$	=	90 V	120 V	135 V
Grid bias . . . . .	$V_{g1}$	=	-5.9 V	-8.1 V	-9.5 V
Standing anode current . .	$I_{a0}$	=	$2 \times 1$ mA	$2 \times 1.5$ mA	$2 \times 1.5$ mA
Anode current at max. modul.	$I_a \text{ max}$	=	$2 \times 4.4$ mA	$2 \times 7.1$ mA	$2 \times 8.2$ mA
Standing screen current . .	$I_{g20}$	=	$2 \times 0.2$ mA	$2 \times 0.25$ mA	$2 \times 0.25$ mA
Screen current at max. modul.	$I_{g2 \text{ max}}$	=	$2 \times 1.3$ mA	$2 \times 1.9$ mA	$2 \times 2.4$ mA
Optimum value of matching resistance (between anodes)	$R_{aa'}$	=	20,000 Ohms	15,000 Ohms	15,000 Ohms
Output power at max. modul.	$W_o$	=	0.5 W	1.1 W	1.5 W
Total distortion . . . . .	$d_{tot}$	=	2.9 %	2.8 %	3.6 %
Required alternating grid voltage . . . . .	$V_{g1 \text{ eff}}$	=	4.9 V	6.4 V	7.4 V

**MAXIMUM RATINGS**

Anode voltage . . . . .	$V_a$	=	max. 135 V	
Anode dissipation (per section) . . . . .	$W_a$	=	max. 0.5 W	
Cathode current				
(per section) . . . . .	$I_k$ at	{	$(I_f = 200 \text{ mA}, V_f = 1.4 \text{ V})$	
		{	$(I_f = 100 \text{ mA}, V_f = 2.8 \text{ V})$	
	at	$I_f = 100 \text{ mA}, V_f = 1.4 \text{ V}$	=	max. 25 mA
Screen grid voltage . . . . .	$V_{g2}$	=	max. 135 V	
Screen dissipation (per section) . . . . .	$W_{g2}$ ( $V_{g1 \text{ eff}} = 0 \text{ V}$ )	=	max. 0.1 W	
	( $W_o = \text{max.}$ )	=	max. 0.4 W	
Grid current commences at . . . . .	$V_{g1}$ ( $I_{g1} = +0.3 \mu\text{A}$ )	=	max. -0.2 V	
Max. external resistance between grid and cathode . . . . .	$R_{g1f}$	=	max. 1 M Ohm	
Minimum limit for filament voltage . . . . .	$V_f$	=	min. 1.1 V	
Maximum limit for filament voltage . . . . .	$V_f$	=	max. 1.5 V	

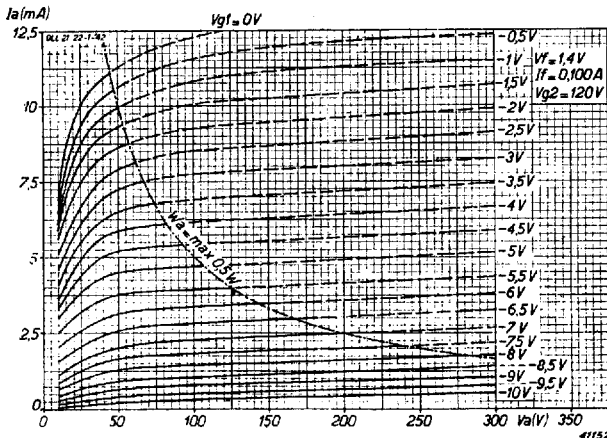

Fig. 8  
Anode current of one pentode section as function of anode voltage at  $V_{g2} = 120 \text{ V}$ ,  $V_f = 1.4 \text{ V}$  and  $I_f = 100 \text{ mA}$ , with  $V_{g1}$  as parameter.

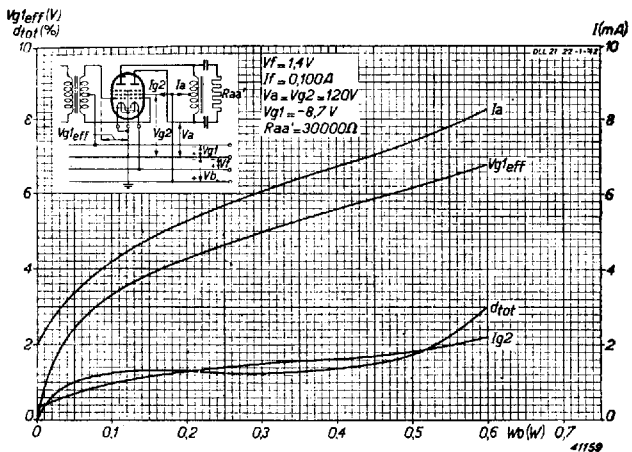

Fig. 9  
 Total anode current and screen current, total distortion and required alternating grid voltage per grid as function of output power, at  $V_b = V_a = V_{g2} = 120 \text{ V}$ ,  $V_f = 1.4 \text{ V}$  and  $I_f = 100 \text{ mA}$ , in push-pull circuit.

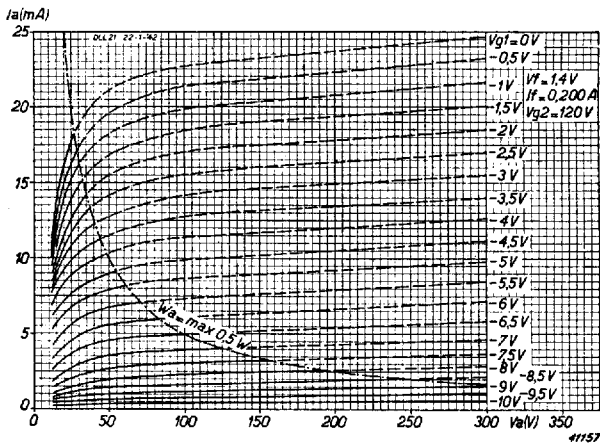

Fig. 10  
 Anode current of one pentode section as function of anode voltage, at  $V_{g2} = 120 \text{ V}$ ,  $V_f = 1.4 \text{ V}$  and  $I_f = 200 \text{ mA}$ , with  $V_{g1}$ , as parameter.

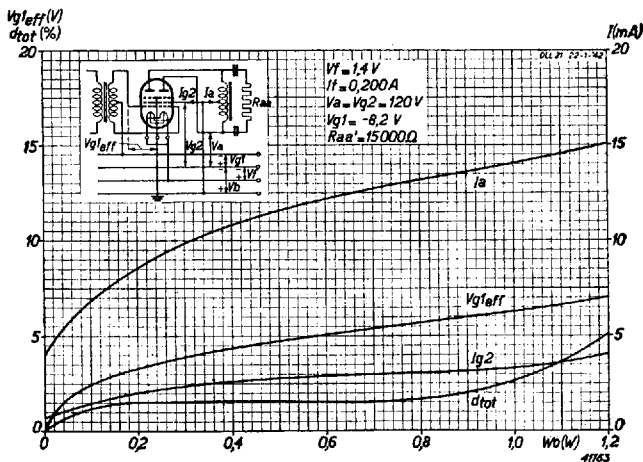

Fig. 11  
 Total anode current and screen current, total distortion and required alternating grid voltage per grid, as function of output power, at  $V_b = V_a = V_{g2} = 120 \text{ V}$ ,  $V_f = 1.4 \text{ V}$  and  $I_f = 200 \text{ mA}$  in class B circuit.

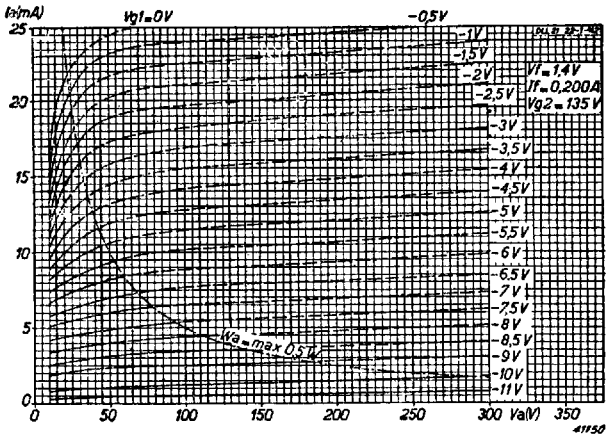

Fig. 12  
Anode current of one pentode section as function of anode voltage at  $V_{g_2} = 135\text{ V}$ ,  $V_f = 1.4\text{ V}$  and  $I_f = 200\text{ mA}$ , with  $V_{g_2}$  as parameter.

APPLICATIONS

The DLL 21 was designed for Class B output stages, or, with the two sections connected in parallel, for Class A operation, but in view of the comparatively high anode current the latter arrangement will seldom be adopted. In Class B circuits grid bias should be derived from a battery. If a resistance were included in the negative side of the H.T. battery for automatic biasing purposes the voltage would increase too much on strong signals and distortion become excessive.

When employed in conjunction with a dry battery for the filament feed, the valve will usually be connected as in A) above (i.e. 1.4 V, 100 mA).

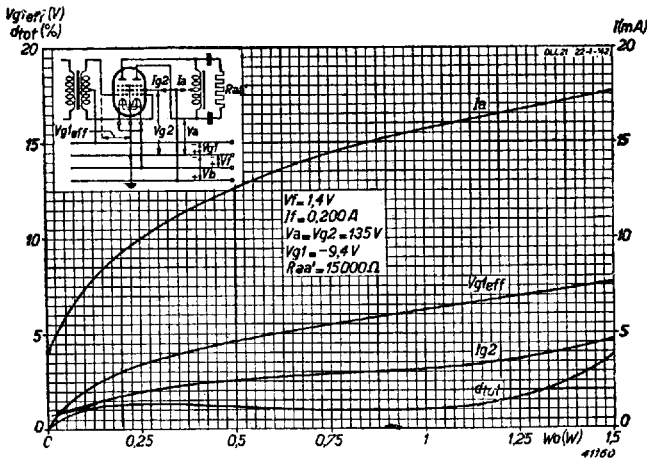

Fig. 13  
Total anode current and screen grid current, total distortion and required alternating grid voltage per grid, as function of the output power at  $V_b = V_a = V_{g_2} = 135\text{ V}$ ,  $V_f = 1.4\text{ V}$ ,  $I_f = 200\text{ mA}$  in Class B circuit.

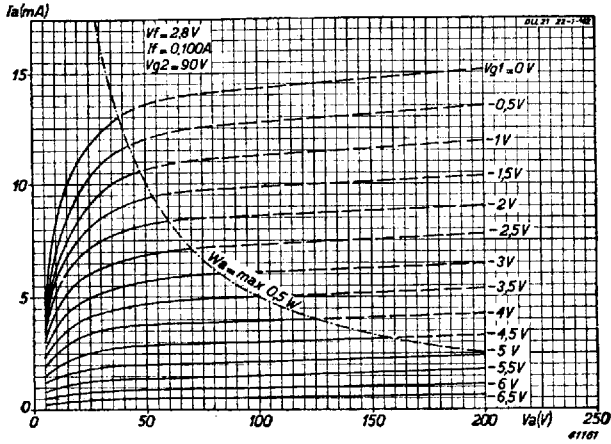

Fig. 14  
Anode current of one pentode section as a function of anode voltage at  $V_{g_2} = 90\text{ V}$ ,  $V_f = 2.8\text{ V}$  and  $I_f = 100\text{ mA}$ , with  $V_{g_1}$  as parameter.

Arrangement B) (1.4 V, 200 mA) is adopted when the valve is to be fed from an accumulator through a resistance, whilst C) (2.8 V, 100 mA), as already stated, is suitable for AC/DC-battery sets. When connected in this manner the DLL 21 delivers an output, at an anode voltage of 135 V, which approximates that of a mains driven receiver. If the set is to be battery fed and the current accordingly limited as much as possible, the set will be switched over very often to the 1.4 V, 100 mA (A) method of wiring. It should be noted that not only the filament but also the loudspeaker should be suitably matched in this case if the receiver is to give its maximum performance.

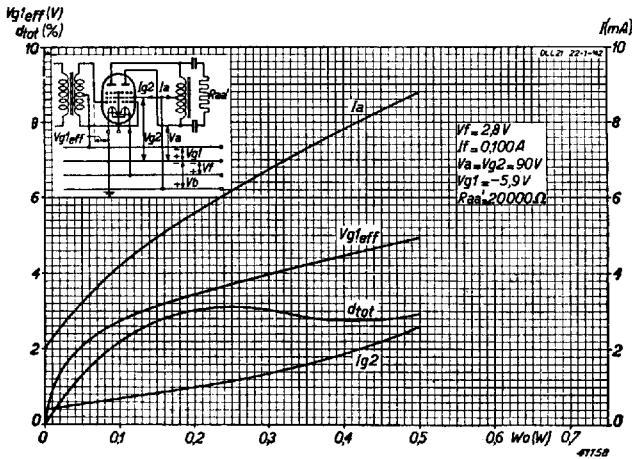

Fig. 15  
Total anode current and screen grid current, total distortion and required alternating grid voltage per grid as function of the output power, at  $V_b = V_a = V_{g_2} = 90\text{ V}$ ,  $V_f = 2.8\text{ V}$  and  $I_f = 100\text{ mA}$ , in Class B circuit.

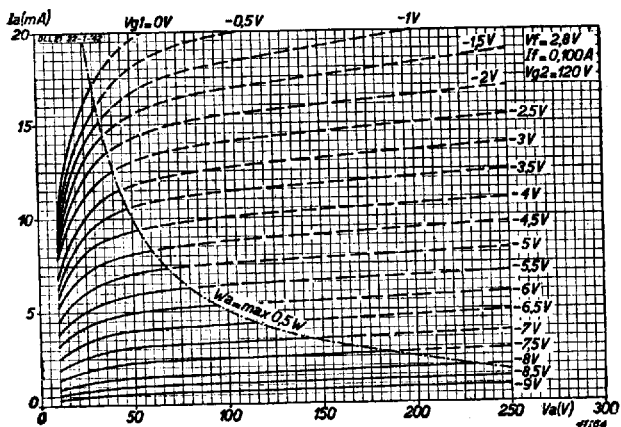

Fig. 16  
Anode current of one pentode section as a function of anode voltage at  $V_{g_2} = 120 \text{ V}$ ,  $V_f = 2.8 \text{ V}$  and  $I_f = 100 \text{ mA}$ , with  $V_{g_1}$  as parameter.

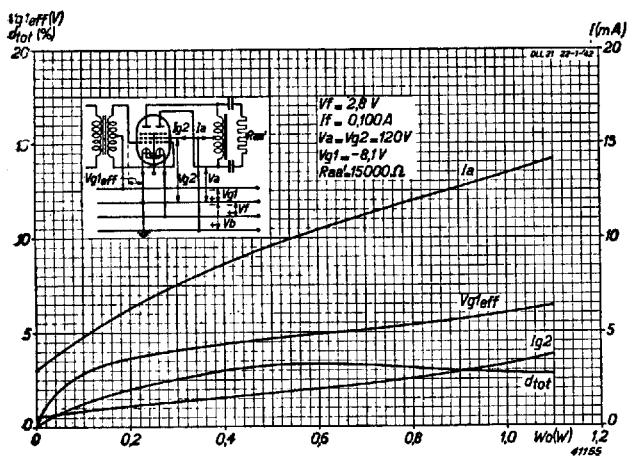

Fig. 17  
Total anode current and screen grid current, total distortion and required alternating grid voltage per grid as function of output power, at  $V_b = V_a = V_{g_2} = 120 \text{ V}$ ,  $V_f = 2.8 \text{ V}$  and  $I_f = 100 \text{ mA}$ , in Class B circuit.

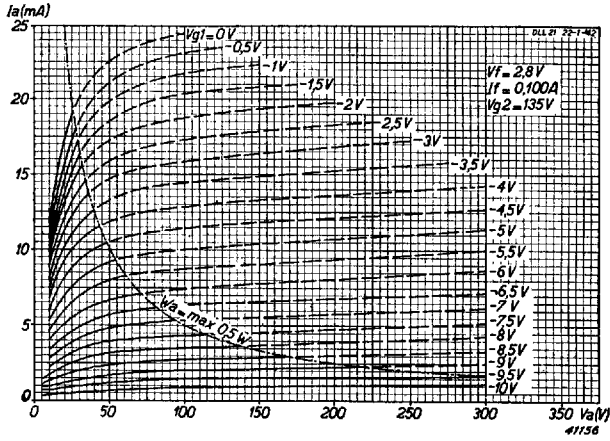

Fig. 18  
 Anode current of one pentode section as a function of anode voltage at  $V_{g_2} = 135$  V,  $V_f = 2.8$  V and  $I_f = 100$  mA, with  $V_{g_1}$  as parameter.

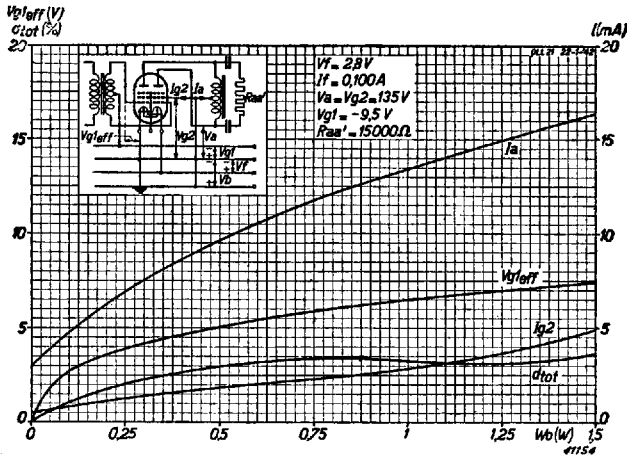

Fig. 19  
 Total anode current and screen grid current, total distortion and required alternating grid voltage per grid as function of output power at  $V_b = V_a = V_{g_2} = 135$  V,  $V_f = 2.8$  V and  $I_f = 100$  mA, in Class B circuit.

# DM 21 Electronic indicator

The electronic indicator is the ideal device for tuning a receiver with the greatest possible accuracy and without the slightest time lag. In the past battery sets have been handicapped, compared with mains receivers, in that no electronic tuning indicators were available for battery operation, but the gap has now been filled by the DM 21.

This tube gives a reliable indication at an anode voltage of 90—120 V, but the lower of these two values should be regarded as absolute minimum; the DM 21 is therefore not suitable for receivers operating on 90 Volts battery.

Another advantage of the indicator is that it always shows that the set is switched on. In view of the possibility of feeding from a dry battery, it was necessary to take into account the fact that the tube should also work satisfactorily on a considerably reduced voltage and the lowest limit for the filament voltage is actually 1.1 V.

### FILAMENT RATINGS

Heating: direct, from a dry battery, rectified alternating current, or D.C. Series or parallel supply.

Filament voltage . . . . .  $V_f = 1.4$  V  
 Filament current . . . . .  $I_f = 0.025$  A

### OPERATING DATA

Battery voltage . . . . .  $V_b = 120$  V      90 V  
 Anode series-resistance . . . . .  $R_a = 2$  M Ohms    2 M Ohms  
 Screen current ( $V_g = 0$  V) . . . . .  $I_s = 0.25$  mA    0.15 mA  
 Grid bias ( $\ominus = 60^\circ$ ) . . . . .  $V_g = 0$  V      0 V  
 Grid bias ( $\ominus = 5^\circ$ ) . . . . .  $V_g = -4$  V       $-3$  V

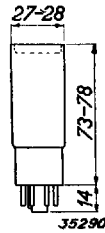

Fig. 1  
Dimensions in mm.

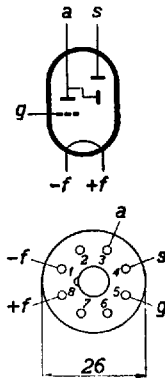

Fig. 2  
Arrangement and sequence of contacts.

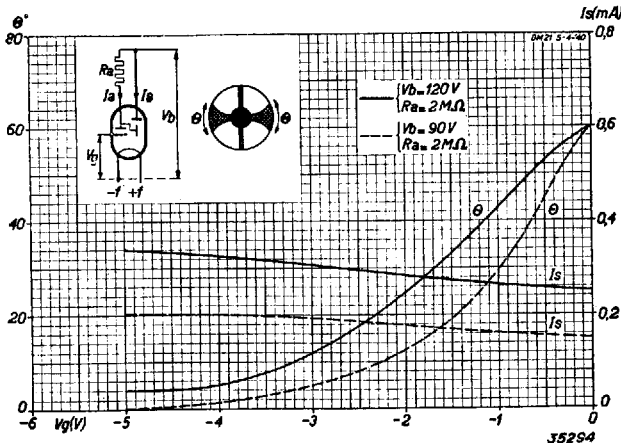

Fig. 3  
Screen current  $I_s$  and shadow angle  $\theta$ , measured at the edge of the screen, as function of grid bias at battery voltages of 120 V and 90 V.

## DM 21

### MAXIMUM RATINGS

Anode voltage . . . . .	$V_a = \text{max. } 135 \text{ V}$
Maximum screen voltage . . . . .	$V_s = \text{max. } 135 \text{ V}$
Minimum screen voltage . . . . .	$V_s = \text{min. } 90 \text{ V}$
Grid current commences at . . . . .	$V_g (I_g = + 0.3 \mu\text{A}) = 0 \text{ V}$
Max. external resistance in grid circuit . . . . .	$R_g = \text{max. } 3 \text{ M Ohms}$
Minimum limit for the filament voltage . . . . .	$V_f = \text{min. } 1.1 \text{ V}$
Maximum limit for the filament voltage . . . . .	$V_f = \text{max. } 1.5 \text{ V}$

### APPLICATIONS

As already stated, the DM 21 gives a reliable indication at an anode and screen voltage of 90—120 V. Since 90 V is the lowest permissible limit, this tube cannot be employed in receivers working on a maximum battery voltage of 90 V.

In the case of series-parallel circuits, precautions must be taken as given on p. 82.



# DAH 50 Diode heptode with space-charge grid

As the type number indicates, the DAH 50 consists of a diode and a heptode. In contrast with existing combination valves in which the different electrode-systems are mounted one above the other, the diode and heptode of the DAH 50 are assembled side by side and separated from each other by a screen.

The heptode should be regarded as a pentode with two special grids (see Fig. 3): between the filament (1) and the first grid (6) of the pentode part there is an auxiliary electrode (2), consisting of two rods (connected to the filament), between which electrons are bunched and forced to travel along certain paths. The second grid (4) is a space-charge grid. As the reader will be aware, the latter makes it possible for the valve to operate on a very low anode voltage: this grid is maintained at the same potential as the anode and draws away electrons from the cathode, so that a virtual cathode (5) is established immediately in front of the control grid of the pentode. It has been found possible by this means to operate the valve at an anode voltage of at most 15 V, at which potential the mutual conductance is 0.65 mA/V.

Taking these two electrodes into account, the valve may be looked upon as a heptode. The diode and heptode systems each have their own filaments, the two being connected in series; one end of each is attached to one of the pins of the valve, and the other ends are joined inside the valve, the centre point being likewise connected to one of the pins.

The voltage per filament is 1.4 V and the current 25 mA; the filaments can accordingly be employed in series or in parallel, as desired. In parallel the filament voltage is 1.4 V and the current 50 mA, whilst in series the voltage is 2.8 V and the current 25 mA: however, if only one section of the valve is used, namely either the diode or the heptode, the filament voltage will be 1.4 V and the current only 25 mA.

The very low voltages on which the DAH 50 operates make it suitable for use in extremely small receivers; for example, a 15 V battery for the anode and a pencil battery of 1.4 V for the filament, or 4 pocket-torch batteries of 4.5 V for both filament and anode may be used. Naturally, the output is not sufficiently high to drive a loudspeaker.

The DAH 50 is quite suitable for short-wave reception, since the input impedance is still very good at wavelengths down to 6 metres. The valve is equipped with the 8-pin base, with centre pilot.

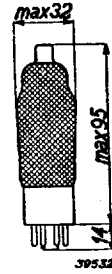

Fig. 1  
Dimensions in mm.

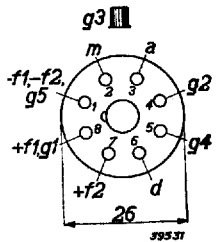
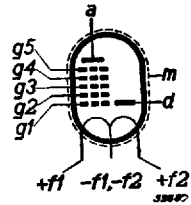

Fig. 2.  
Arrangement and sequence of contacts.

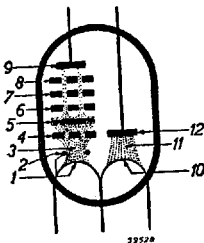

Fig. 3  
Diagram showing the working of the DAH 50. 1) = filament, 2) = auxiliary electrode for bunching the electrons 3, 4) = space-charge grid, 5) = virtual cathode, 6) = control grid, 7) = screen grid, 8) = suppressor grid, 9) = anode of the heptode section, 10) = filament of the diode section, 11) = electron stream in the diode, 12) = anode of diode.

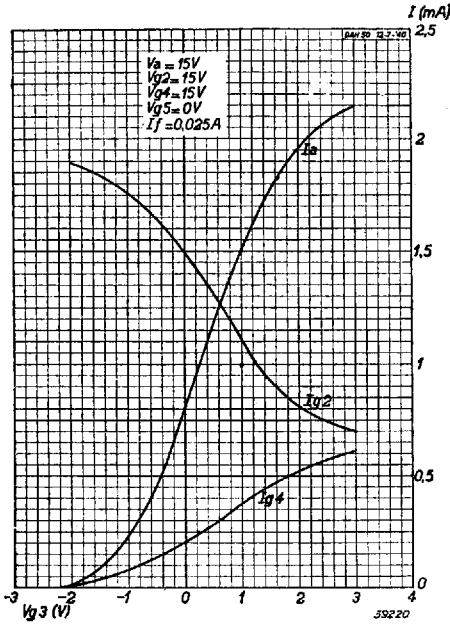

Fig. 4  
 Anode current, space-charge grid current and screen grid current as function of the grid bias on grid 3 (control grid), at  $V_a = V_{g2} = V_{g4} = 15 V$ .

**FILAMENT RATINGS**

Heating: direct, by means of a battery; series or parallel.

Heptode section	pins 1 and 8	filament voltage . . . . .	$V_f = 1.4 V$
		filament current . . . . .	$I_f = 0.025 A$
Diode section	pins 1 and 7	filament voltage . . . . .	$V_f = 1.4 V$
		filament current . . . . .	$I_f = 0.025 A$
Diode-heptode	pins 1 and 7 + 8		
	(parallel)	filament voltage . . . . .	$V_f = 1.4 V$
		filament current . . . . .	$I_f = 0.050 A$
	pins 7 and 8		
	(series)	filament voltage . . . . .	$V_f = 2.8 V$
		filament current . . . . .	$I_f = 0.025 A$

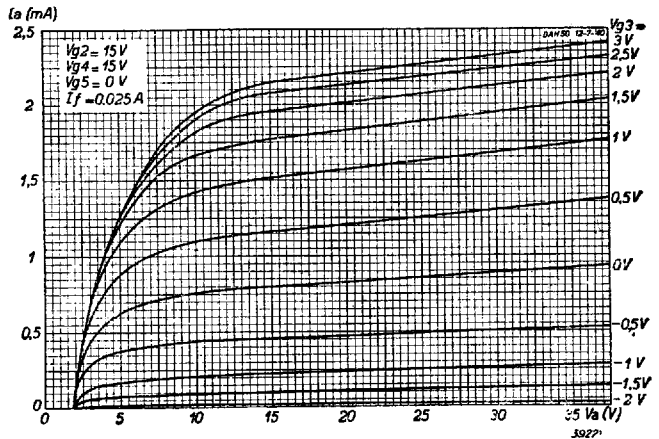

Fig. 5  
 Anode current as a function of anode voltage, with  $V_{g3}$  as parameter.

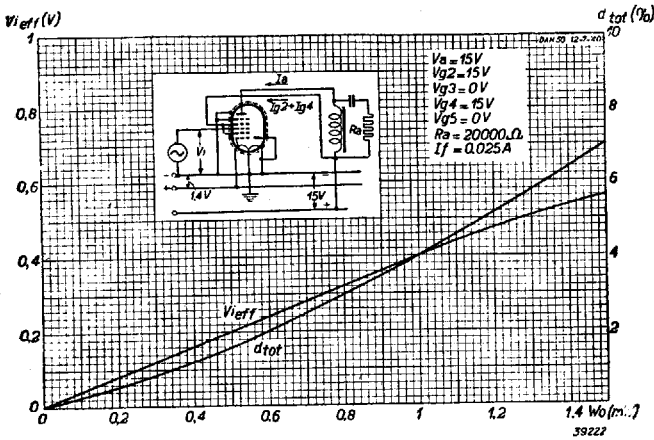

Fig. 6  
Alternating input voltage and total distortion as function of output power; DAH 50 used as output valve.

**CAPACITANCES**

$C_{ag3}$	< 0.04 pF	$C_{ad}$	< 0.05 pF
$C_a$	= 9.8 pF	$C_{gsd}$	< 0.001 pF
$C_{gs}$	= 7.3 pF	$C_{df}$	= 4.1 pF

**STATIC RATINGS**

Anode voltage . . . . .	$V_a$	= 15 V
Space-charge grid voltage . . . . .	$V_{g2}$	= 15 V
Grid bias . . . . .	$V_{g3}$	= 0 V
Screen grid voltage . . . . .	$V_{g4}$	= 15 V
Suppressor grid voltage . . . . .	$V_{g5}$	= 0 V
Anode current . . . . .	$I_a$	= 0.8 mA
Current to the space-charge grid . . . . .	$I_{g2}$	= 1.5 mA
Screen grid current . . . . .	$I_{g4}$	= 0.2 mA
Mutual conductance . . . . .	$S$	= 0.65 mA/V
Internal resistance . . . . .	$R_i$	= 0.09 M Ohms
Gain factor . . . . .	$\mu$	= 60

**OPERATING DATA for use as A.F. amplifier valve**

Anode voltage . . . . .	$V_a$	=	15 V
Suppressor grid voltage . . . . .	$V_{g5}$	=	0 V
Anode series resistance . . . . .	$R_a$	=	0.05 M Ohm 0.1 M Ohm
Series resistance, space-charge and screen grids . . . . .	$R_{(g2 + g4)}$	=	4000 Ohms 6000 Ohms
Grid bias . . . . .	$V_{g3}$	=	0 V 0 V
Anode current . . . . .	$I_a$	=	0.13 mA 0.07 mA
Current to space-charge and screen grids . . . . .	$I_{(g2 + g4)}$	=	1.1 mA 0.9 mA
Gain factor . . . . .	$V_o/V_i$	=	12 15
Total distortion . . . . .	$d_{tot}$	=	2.0 % 2.5 %
Alternating output voltage . . . . .	$V_{o\ eff}$	=	1 V 1 V

**OPERATING DATA for use as output valve**

Anode voltage . . . . .	$V_a$	=	15 V	
Space-charge and screen grid voltage . . . . .	$V_{(g_2 + g_4)}$	=	15 V	
Suppressor grid voltage . . . . .	$V_{g_5}$	=	0 V	
Grid bias . . . . .	$V_{g_3}$	=	0 V	
Anode current . . . . .	$I_a$	=	0.8 mA	
Current to space-charge and screen grids . . . . .	$I_{(g_2 + g_4)}$	=	1.5 mA	
Optimum value of matching resistance . . . . .	$R_a$	=	20,000 Ohms	
Output power . . . . .	$W_o$	=	0.5 mW	1 mW
Required alternating grid voltage	$V_{i\ eff}$	=	0.2 V	0.4 V
Total distortion . . . . .	$d_{tot}$	=	1.6 %	4 %
				7 %

**MAXIMUM RATINGS**

Heptode section:

$V_a$	= max. 25 V
$W_a$	= max. 0.05 W
$V_{g_2}$	= max. 15 V
$W_{g_2}$	= max. 0.025 W
$V_{g_4}$	= max. 25 V
$W_{g_4}$	= max. 0.01 W
$I_k$	= max. 2.5 mA
$V_{g_3}$ ( $I_{g_3} = +0.3 \mu A$ )	= max. -0.4 V
$R_{g_3j}$	= max. 3 M Ohms

Diode section:

$V_d$	= max. 50 V
$I_d$	= max. 0.2 mA
$V_d$ ( $I_d = +0.3 \mu A$ )	= max. -1 V

**APPLICATIONS**

The DAH 50 is especially useful in small portable receivers with headphones, in which it can be employed in all stages. In connection with the various applications of this valve the following will be of interest.

For reception by means of headphones in a quiet room an output of 1 mW may be considered sufficient, this being at a resistance of 4000 Ohms (the resistance value of standard headphones), the equivalent of an anode current of 0.5 mA. Used thus, the DAH 50 gives best results with automatic grid bias, as distortion due to grid current, which occurs at  $I_a = 0.7$  mA, is avoided.

When used as A.F. amplifier with an anode coupling resistance of 100,000 Ohms, the valve gives a gain factor of 15 at the maximum supply voltage of 15 V.

For detection sensitivity of the diode unit the characteristics of other battery diodes in the D-series may be consulted.

In R.F. and I.F. amplification stages it must be remembered that the internal resistance of 0.1 M Ohm damps the tuned circuit; therefore, to ensure a satisfactory relation between selectivity and amplification, the anode may be connected to a tapping in the primary circuit of the I.F. bandfilter. Alternatively, the damping may be compensated by a moderately strong reaction back in the I.F. circuits. For example, if the anode is connected to a tapping half way down the anode coil, the I.F. circuit is damped to the extent of  $2^2 \times 0.1 = 0.4$  M Ohms, but this need not necessarily affect the I.F. circuit too much, even if the impedance is, say, 0.3 M Ohms. When the bandfilter is

thus tapped on the primary side a gain factor of 30 may be obtained.

By means of slight reaction back, it is further possible to increase the I.F. gain by a factor of 2 or 3.

If required, the DAH 50 can also be employed as frequency-changer, mixing being achieved by inducing the auxiliary signal in the cathode circuit. The second grid is used as anode for the oscillator section. There is, however, a slight difficulty here, in that the cathode is directly-heated and each of the filament circuits must include a reaction coupling coil; these coils should be bifilar-wound and coupled to the tuning coil of the oscillator circuit. It is found that good results are obtained in this case only when the anode voltage is increased to 24 V, the nominal voltage of 15 V being insufficient. Employing rather tight coupling, a voltage of about 1.5 V can be obtained in the anode circuit.

As is the case when the valve is used as I.F. amplifier, it is advisable to have a tapping in the anode circuit of the mixer valve. The conversion gain factor is 15. The circuit diagram No. VIII on p. 142 shows a practical application of this valve in a baby-midget set employing two such valves.

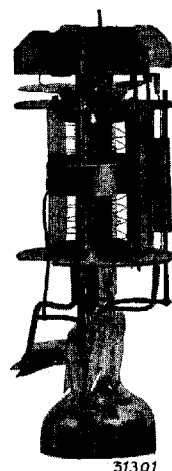

31301  
Fig. 4  
The electrode system of the DAH 50; on the left the heptode, on the right the diode unit.

# Applications of the 1.4 battery valves in universal receivers for AC/DC-Battery operation

## Working principle and problems in connection with the circuits

Apart from battery receivers, the D-series of valves also finds application in universal receivers operated from batteries, A.C. or D.C. (known in short as ABC sets). This type of receiver has the following features:

- 1) It can be operated, without any auxiliary apparatus such as vibrator converters or other complicated devices, not only from a battery, but also from the mains, either A.C. or D.C. A receiver of this type can therefore be made portable—if desired with a built-in aerial—the circuit being such that it is quite independent of local sources of voltage; in fact, it can be operated anywhere.
- 2) Since the current consumption, even when working on the mains, is extremely low, a receiver of this type is a great asset in all cases where electricity rates are high.

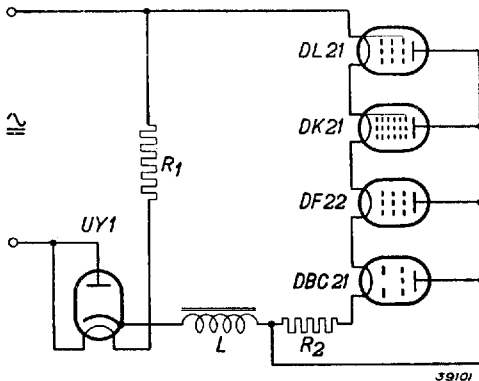

Fig 1  
Circuit diagram of the supply section of an AC/DC-Battery receiver.

### Principle

In view of the ripple that occurs when the filaments are heated by alternating current, these valves cannot be fed direct from the mains. The A.C. is first rectified and the rectified current is smoothed and supplied to the valves through resistances, which means that the rectifier not only furnishes the anode and screen grid currents, but also the filament current. For reasons of economy, of course, the valves are fed in series and the total current to be supplied by the rectifier, in conjunction with the 1.4 V valves, such as the DK 21, DF 22 (current consumption 50 mA), is 65 mA (50 mA filament current and about 15 mA for the anodes and screen grids). For this purpose the UY 1 (N) can be employed, the rectified current output of this valve being maximum 140 mA, which is also sufficient in the case where a DLL 21 is used in the output stage (100 mA at 2.8 V). Fig. 1 shows the circuit details for use with the DL 21, DK 21, DF 22, DBC 21 and rectifier UY 1.

Although series-connection is indicated for mains operation, parallel wiring will be more suitable for battery operation, the battery being of the 1.4 V size.

Normally, a transfer from mains to battery operation would entail fairly complicated switching arrangements, but this can be avoided by wiring the filaments in such a way that a maximum of 100 mA is consumed, with the greatest possible economy when working from a battery: in practice this is generally met by a series-parallel arrangement of wiring.

### Series-parallel wiring

As is generally known, series-parallel valve circuits, or a resistance in series with parallel-coupled valves will in certain circumstances involve the risk of one or more valves being very heavily overloaded. Take for instance the simple group of valves DF 21 - DF 21 - DL 21. When the set is operated on mains the filament current will be supplied

by the rectifier valve and, since the rectified voltage is 100 to 200 V, according to the voltage of the mains, it is necessary to include a series-resistance of a very high value as compared with the resistance of the filaments: this, then, mainly determines the current in the filament circuit. Now, should the filament current of one of the 25 mA valves be interrupted for any reason, such as the breaking of a filament, bad contact in the valveholder, or the simple removal of one of the valves from the set for inspection purposes, a current of about 50 mA will pass through the 25 mA valve connected in parallel with it. Such overloads can easily be avoided by including a resistance in each parallel branch (see Fig. 2).

When the set is to be used with a battery the points *a* and *b* have to be connected,

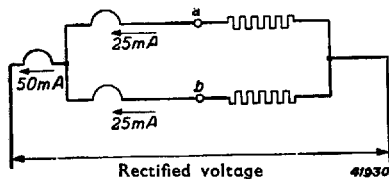

Fig. 2

A 50 mA valve in series with two parallel-connected 25 mA valves, operated from the mains. To protect one of the latter from overloading caused by an open-circuit in the other, a separate resistance is included in each current branch.

which immediately entails a complication when switching over from mains to battery operation. If this device cannot be adopted it is essential that the valveholders ensure adequate and reliable contact with the valve pins, whilst the valves must in no circumstances be removed from the set while working. In some instances the number of valves exposed to the risk in question can be limited by means of suitable connections in the series-parallel circuit.

Fig. 3 shows a circuit diagram of the DK21—DF 21—DAC 21—DL 21; the excess voltage caused by an interruption in a

series-parallel circuit is usually greater in the case of battery operation.

*Graphical illustration of the excess voltages that may occur*

By means of the characteristics in Fig 4 it is possible to illustrate very simply the excess voltage that may occur in different given circumstances. In this figure the filament voltage is plotted as a function of the filament current for 25, 50 and 100 mA valves. Taking the case of the three valves DF 21—DF 21—DL 21 once more, a 25 mA valve in series with a 50 mA valve working from a battery will receive 2.8 V when the filament of one of the 25 mA valves is open-circuited, with no series-resistance, as shown in Fig. 2. The voltage on each valve is then found at the point of intersection of the 25 mA curve with the 50 mA curve. From Fig. 5 it will then be seen that the filament voltage of the 25 mA valve is 2.1 V.

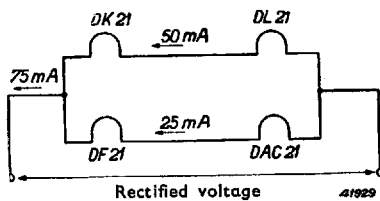

Fig. 3

Logical series-parallel circuit of 50 and 25 mA valves.

The circuit diagram shown in Fig. 6 in respect of the DK 21—DF 21—DAC 21—DL 21 represents a more complex example. Here, if the filament circuit of one of the 25 mA valves is broken, two 50 mA valves are left in series with one 25 mA valve. The battery voltage is 4.2 V and the voltage received by the 25 mA valve can be read from the point of intersection of the curve for a 25 mA valve with that in respect of two series-connected 50 mA valves.

The last mentioned curve is easily derived from the curve for a single 50 mA valve, by doubling the voltage scale of Fig. 4.

*Sequence of the valves*

In series circuits it would be logical to connect the valve requiring the highest grid bias to the positive end of the supply, thus utilising the potential drop across the

filaments of the other valves. In AC/DC receivers there is, however, an objection to this; the highest grid bias is usually required by the output valve, which is accordingly connected to the positive side. In this case the anode current of the output valve also passes through the filaments of the preceding valves (Fig. 7). The filaments of the first two valves have also to carry the anode current of the penultimate valve, while the filament current of the first valve is augmented by the anode current of the three following valves. When the valves are battery-fed

Fig. 4  
Filament voltage as a function of filament current of 25, 50 and 100 mA valves.

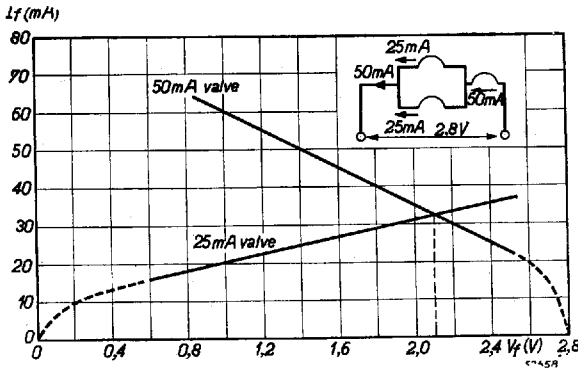
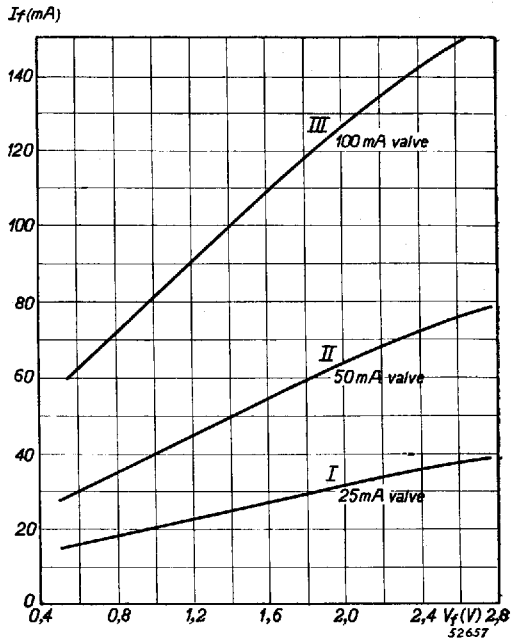
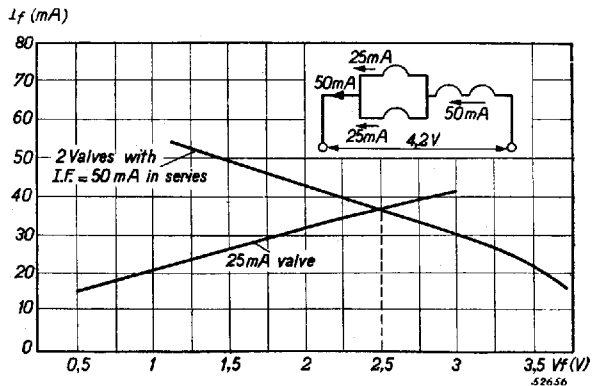

Fig. 5  
Graphical representation of excess voltage on one of two parallel-connected valves when the filament of the other is open-circuited. DF 21—DF 21—DL 21, connected for feeding from a 2.8V battery.

Fig. 6  
Graph showing excess voltage on one of two 25 mA valves in parallel, when the filament of the other is open-circuited. DK 21—DF 21—DAC 21—DL 21 connected for feeding from a 4.2 V battery.





this is not so serious, since part of the anode current then flows through the filament battery, but on mains the total anode current flows through the filaments of the initial valves. To prevent this overloading a resistance would have to be connected in parallel with the filaments of the valves in question, but as such resistances would be of a different value for battery operation than for mains feeding this particular arrangement of the valves is not suitable for universal receivers.

Another objection to this circuit is that even if overloading is prevented by employing resistances in parallel, anode current variations in the output valve still set up filament variations in the preceding valves. These in turn result in unwanted coupling, which can be avoided only by placing a large condenser in parallel with the filaments.

Obviously, then, the arrangement whereby the output valve is connected to the positive end of the series entails numerous difficulties, for which reason the feeding of an ABC type of receiver is based on a different sequence of the valves, with an alternative method of obtaining grid bias for the output valve. The other valves do not present quite such a problem, as the voltage drop across the filaments can be utilised for biasing, if required. The order of the other valves in Fig. 1 is such that the voltage drop across the filaments of the DK 21, DF 22, DBC 21 can be employed as delay voltage for the automatic gain control. Grid bias for the DF 22 is provided by the voltage drop across the filament of the DK 21, which itself it not given a fixed bias. The circuit shown in diagram VII (page 137) is arranged in this manner.

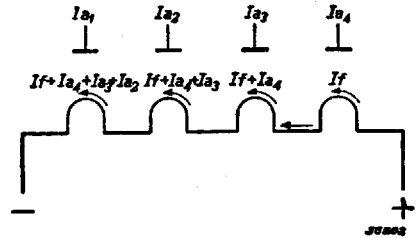

Fig. 7  
Filaments connected in series, with the output valve connected to the positive side of the supply to provide grid bias. A disadvantage of this arrangement is that the anode current of following valves also passes through the filaments.

#### *Current-economy circuits for mains operation*

For battery work low current consumption is of the first importance, but in some cases it is desirable also when operating from the mains, and the circuit diagram shown in Fig. 8 will ensure quite a considerable saving in current. Here, the filament of the rectifier does not provide a separate path for the current but is connected in series with the filaments of the receiving valves. Since no current flows in this circuit when the cathode of the rectifier is cold, the circuit has first to be "started up", by closing a switch,  $S_1$ , across the rectifier, for a few moments. Actually, it must not be opened again until the rectifier has reached the temperature necessary for rectification. It will be seen that the short circuit is not applied directly across the rectifier; if this were done the first smoothing condenser would be placed in direct contact with the mains, which is not desirable on A.C. On D.C., moreover, difficulties may arise if the question of polarity is not taken into account. Whilst the rectifier is warming up the filaments of the other valves are short-circuited to protect them from possible damage due to the initial current surge. In Fig. 8 switch  $S_2$  is coupled to  $S_1$  for this purpose.

The saving in current by this means is not inconsiderable; in the case of the DLL 21 employed as output valve, the filament current being 100 mA, this same current flows through the filaments of the other valves and rectifier. If the total anode current is, say, 15 mA, the current taken from the mains will be 115 mA, whereas in a standard receiver 115 mA would be required for the receiving valves and a further 100 mA for the rectifier. When the DL 21 is used as output valve the current passing through the amplifier valves is only 50 mA, and assuming once more that the anode current is

15 mA, the filaments have to be bridged by a resistance to take up the remaining 35 mA, in which case the total amount of current taken from the mains is 100 mA, as against 165 mA in any other ordinary circuit. An objection to this economy circuit is of course the fact that the receiver is not switched on in one operation, but in two stages. This can be overcome, however, by employing a relay to actuate the switch as soon as the necessary current is established at the first smoothing condenser. The relay can also take care of the switching arrangements for the change-over from battery to mains operation.

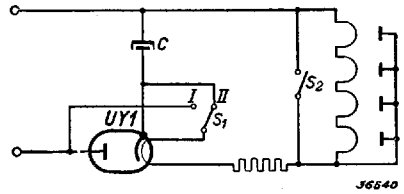

Fig. 8  
Current economy circuit in which the rectifier valve is switched by  $S_1$  for a short time after the receiver has been placed under tension. While the rectifier is warming up, the filaments of the receiving valves are short-circuited by switch  $S_2$ .

### Universal circuits

A universal circuit is understood to be one which will enable the receiver to be operated from any source of voltage, without any switching operations on the part of the user. When transferring from battery to mains the battery must always be disconnected, to prevent it from being charged or discharged by the mains; a relay is therefore required to open the connection to the batteries as soon as the receiver is connected to the mains. This relay can be used for other purposes as well, such as switching over the filament circuit, for varying the circuit producing the grid bias or for shorting the rectifier valve during the warming-up period, in the manner described above.

If the circuit be so arranged that the receiver is set for battery operation when the relay is "off", the receiver, when connected to the mains, will first be fed from the batteries and switched to the mains only when the rectifier has warmed up, thus giving an impression of a very short warming-up period.

Fig. 9 gives an example of a universal circuit. The main switches  $S_1$  and  $S_2$  are mechanically ganged. Switches  $r_1$  to  $r_4$  are operated by the relay, being shown in the "off" position: if the set is not connected to the mains when switches  $S_1$  and  $S_2$  are closed, it will be fed normally, from the batteries. When the receiver is plugged into the mains the rectifier valve warms up through the switches  $r_1$  and  $r_2$ . The smoothing circuit is not included in the filament pre-heating circuit, since the filament current would then be limited too much by the choke coil when operating on mains, whilst moreover, the condensers should not be normally connected direct to the mains. As soon as the cathode reaches the required temperature a direct voltage develops

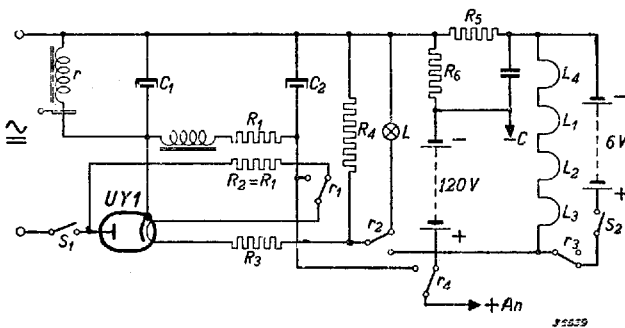

Fig. 9

Example of a universal circuit for the supply section of an AC/DC-battery receiver.  $S_1$  and  $S_2$  are the ganged main switches. Switches  $r_1$  to  $r_4$  are operated by the relay  $r$ ; these are depicted in the "off" position in the diagram.

across the condenser  $C_1$  and the relay is energised. Switch  $r_1$  ensures that the rectifier "heats itself" as soon as the cathode is hot enough, whilst including the filaments of the receiving valves in the filament circuit is done by  $r_2$ . The filament battery is then switched off by  $r_3$  and the anode circuit transferred

from the battery to the rectifier by switch  $\tau_4$ .

Resistance  $R_1$  ensures the correct value for the anode voltage and  $R_2$  further reduces this voltage to the value required for the filaments of the valves.  $R_4$  takes up the difference between the filament current of the UY 1 and the current required by the receiver. When the rectifier has warmed up,  $R_2$  takes over the function of  $R_1$ .

One drawback of the circuit in Fig. 8 is this, that in the case of incorrect polarity, such as may occur with direct current mains, the relay does not switch over the set from "battery" to "mains". In that event the rectifier UY 1 is certainly heated up, but the anode is then negative, so that no voltage is established across the smoothing condenser  $C_1$  and the set continues to work from the batteries, without the user being aware of it. To prevent this waste of battery current a "tell-tale" can be fitted to indicate when the set is working from the batteries. In the above mentioned circuit a lamp  $L$  is employed for this purpose and this lights up while the rectifier is heating, but does not burn when the receiver is working normally.

If the designer prefers not to leave the matter to the attentiveness of the user, another method can be employed, in which the relay—if necessary of the thermal type—is energised direct from the mains, but this has the effect of extending the warming up period. If the polarity is incorrect the relay operates, no voltage occurs at condenser  $C_1$  and the receiver cannot function.

---

<sup>1)</sup> If it can be assumed that the filaments during the heating up period are sufficiently shunted by the low resistance of the battery,  $\tau_2$  may be dispensed with. The grid bias then has to be supplied by a battery, since otherwise, when the required temperature is reached, alternating current flows through the resistance  $R_3$  serving to provide the bias.



**CIRCUITS**  
**of battery receivers**

## V. Four-valve Battery Receiver

*Valves used:* DK 21—DF 21—DAC 21—DL 21.

### *Description*

This is an example of a simple super-heterodyne receiver for battery operation. The sensitivity of a circuit of this type is not particularly high but is nevertheless quite sufficient for all purposes where a minimum current consumption is required.

### *Waves ranges:*

Long waves	940	—2040 m
Medium waves	197.5	— 572 m
Short waves	18.75—	54 m

### *Batteries*

This receiver requires a 90 V H.T. battery, with a 1.4 V filament battery. Grid bias of the output valve is obtained automatically by means of a resistance. The anode current is about 10 mA and the filament current 150 mA.

### *Coils*

A complete coil unit is employed, comprising R.F. and oscillator coils with trimmers, padding condensers and wave-range switch. This unit is indicated by the dotted-line rectangles in the diagram in order to simplify the outline, but in effect this is a single unit. The voltage gain factor of the aerial circuit is about 3 in all wave ranges.

### *Frequency-changer*

The total current consumption of the mixer valve DK 21 is only 3.8 mA approx., the filament current being 50 mA. The oscillator voltage, as measured at the first grid, should be about 10 V<sub>eff</sub>. Voltage for the fifth grid is obtained by means of a series-resistance. In the medium and long waves the frequency-changer is included in the automatic gain control system, but not on the short waves. This valve gives a conversion gain factor of approx. 50.

### *I.F. circuits*

The I.F. coils are wound on iron cores and are mounted in a "Philite" box. They comprise  $2 \times 155$  turns of  $24 \times 0.04$  mm Litz wire. The I.F. circuit capacitance is provided by a 100 pF condenser.

The self-inductance of the I.F. coils is approx. 1 mH and the circuits are trimmed to the I.F. (470 kc/s) by means of the iron cores.

### *I.F. valve*

The DF 21 is employed as I.F. amplifier, the filament current being only 25 mA and the anode and screen grid currents roughly 1.5 mA. This valve is controlled by the A.G.C. in all the wave ranges and the I.F. gain factor is approx. 50.

### *Detector and A.F. amplifier*

The filament current of the DAC 21 is also 25 mA, whilst the anode current in this particular circuit is about 0.4 mA. The diode is connected to a tapping on the secondary side of the final I.F. transformer and also serves to provide the control voltage.

### *Output valve*

The DL 21, employed as output valve, has an anode current of only 4 mA, with a screen grid current of 0.7 mA, the filament current being 50 mA. Grid bias for this valve

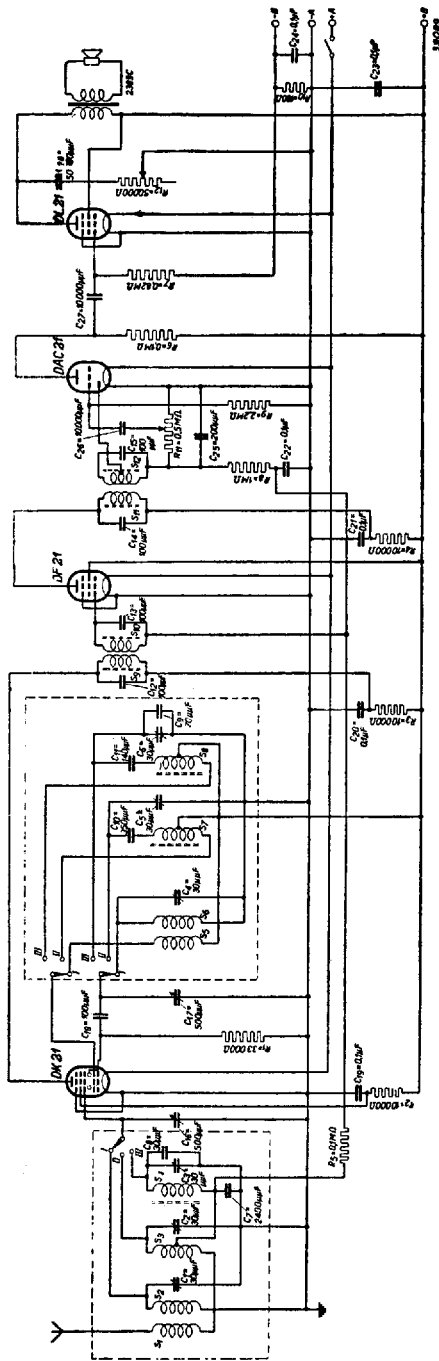

SIGNAL REPELLER  
 I V B  
 1W 4W 1W  
 1000Ω 1000Ω  
 RESISTORS OF INTERCHANGEABLE TYPE

Fig. 1 (Published without any guarantees in respect of patent rights.)

Circuit diagram of 4-valve super-heterodyne battery receiver

is provided by a resistance  $R_{10}$  and a separate battery is therefore not required. The DL 21 is capable of an output of 170 mW and, to provide the optimum matching impedance of 22,000 Ohms, a relatively large output transformer should be used. A transformer of this type, however, will as a rule be too costly for a small, low-priced receiver, but at the same time the maximum available output power will be correspondingly lower if a smaller transformer is used.

**TECHNICAL DATA**

Filament current	DK 21	50 mA
	DF 21	25 mA
	DAC 21	25 mA
	DL 21	50 mA
	Total	150 mA

<i>Anode current</i>	DK 21	3.8 mA
	DF 21	1.5 mA
	DAC 21	0.4 mA
	DL 21	4.7 mA
	Total	10.4 mA

*Sensitivity* (for an output of 50 mW)  
 at the detector diode 0.5 V  
 at the aerial 70  $\mu$ V  
 I.F. gain factor 50  
 conversion gain factor 50  
 voltage gain factor 3

*Selectivity*

Attenuation on a variation in tuning of +4.5 and -4.5 kc/s 1 : 10.  
 Attenuation on a variation in tuning of +8 and -8 kc/s 1 : 100.  
 Attenuation on a variation in tuning of +13 and -13 kc/s 1 : 1000.

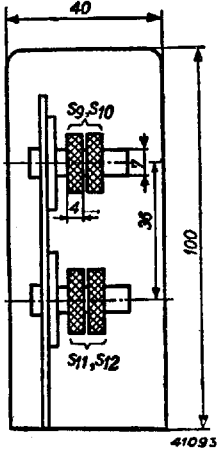

Fig. 2  
 Sketch of the I.F. bandfilter coils.  $S_9$ ,  $S_{10}$ ,  $S_{11}$  and  $S_{12}$  =  $2 \times 155$  turns  
 Litz wire wound on iron cores and mounted in a "Phillite" box.



## VI. 5-Valve battery receiver

Valves used: DK 21—DF 21—DF 21—DAC 21—DL 21.

### Description

The difference between this and the circuit described in V lies in the I.F. stage: two such stages are now employed, giving a relatively low current consumption coupled with very high sensitivity ( $3 \mu\text{V}$ ). Two DF 21 valves are used in the I.F. stages, the first of these being incorporated in the A.G.C. system. The anode circuit of this valve includes a single I. F. circuit damped by a resistance of 0.1 Megohm, this giving an I.F. gain factor of 25. Without this resistance the sensitivity would be so high that higher tones would be insufficiently reproduced, and since the circuit is quite selective enough with 4 I.F. circuits one of these can be dispensed with by making the first aperiodic. If a resistance of 0.1 Megohm is connected in the anode circuit the gain factor in respect of the first I.F. stage will be 7, giving a receiver sensitivity of about  $10 \mu\text{V}$ , which may still be considered good.

A bandfilter is provided in the anode circuit of the second I.F. valve; the gain factor for this stage is 50. The use of an extra I.F. stage has this advantage over an additional R.F. stage that the amplification is then independent of the wavelength and the sensitivity therefore constant in all wave ranges. (As is known, R.F. stages amplify less on short waves than on medium and long waves.)

The anode current of the receiver is approximately 12 mA and the filament current 175 mA.

### TECHNICAL DATA

<i>Sensitivity</i> (for an output of 50 mW)	
at the detector diode	0.5 V
I.F. amplification II	50
I.F. amplification I	25
conversion amplification	50
voltage gain factor	3
at the aerial	approx. $3 \mu\text{V}$

### Selectivity

Attenuation when set is detuned +3 and -3 kc/s:	1 : 10.
Attenuation when set is detuned +6 and -6 kc/s:	1 : 100.
Attenuation when set is detuned +9 and -9 kc/s:	1 : 1000.

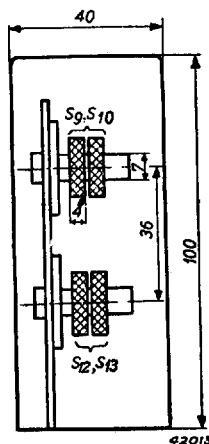
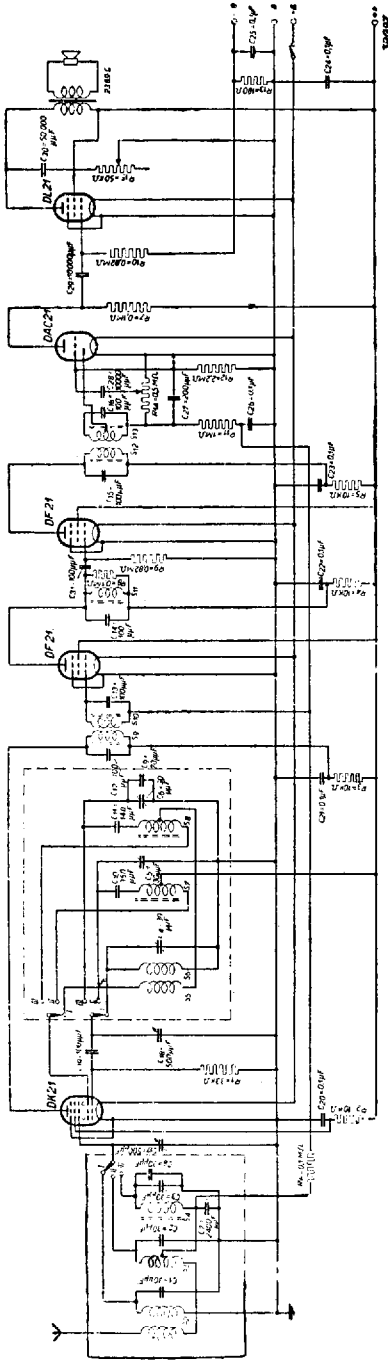

Fig. 1  
Sketch of the I.F. band-filter coil unit.  $S_7$ ,  $S_{10}$ ,  $S_{12}$  and  $S_{13}$  (also  $S_{11}$  in the circuit diagram) =  $2 \times 155$  turns of litz wire  $24 \times 0.04$  mm wound on iron cores and mounted in a Philite box.



6N21 PENTODE  
 PARTS OF CHRYSLER  
 6F21 PENTODE  
 6F21 PENTODE  
 6N21 PENTODE

(Published without any guarantees in respect of patent rights.)  
 Fig. 2  
 Circuit diagram of a 5-valve superheterodyne battery receiver

## VII. 4-valve super-heterodyne receiver for 110/220 V AC/DC mains and battery operation.

*Valves used:* DK 21—DF 22—DBC 21—DL 21—UY 1.

*Wave-ranges:*

Long waves	830—2090 m
Medium waves	200— 570 m
Short waves	17— 51 m

### *R.F. and Oscillator circuits*

A standard set of coils is used, the R.F. and oscillator coils with trimmers and padding condensers as well as the wave-range switch being assembled as a compact unit. By this construction the oscillator coil is coupled capacitively and inductively to the control grid of the frequency-changer and the resultant voltage may therefore be relatively high, resulting in such effects as grid current, "pulling" of the frequency, insufficient voltage gain, etc. so that it is advisable to screen off the short wave (and possibly also the medium wave) circuits and to operate them by separate switches.

The gain factor in respect of the aerial circuit is approximately 3 in all wave-ranges. If trouble is experienced due to whistles, these can generally be suppressed by means of a filter circuit tuned to 470 kc/s interposed between aerial and earth.

The different wave ranges are selected by switching the coils, this being better, as already stated (p. 58), than short-circuiting parts of the coils.

The R.F. circuits are coupled inductively to the aerial circuit and in the medium and long wave ranges the self-inductance of the tuning coil is therefore corrected to the desired value with short-circuited aerial coil. The increase in the self-inductance when the short-circuit is removed is a measure of the coupling between aerial and tuning coils required to produce the required voltage gain. The coils in this unit are designed to give a gain factor of 3 in all wave ranges; when the short-circuit is removed from the aerial coil the self-inductance of the medium wave tuning coil must therefore vary 3 % and that of the long wave coil 8 %. If the coupling is made any tighter, naturally more gain is obtained, but the effect of aerial capacitance is then also increased. A variable condenser of 20—500 pF is taken as the basis of the R.F. circuits, the distributed capacitance in the medium wave range being estimated at 45 pF and that on long waves at 70 pF (trimmers, wiring etc.). The variation in the capacitance on medium waves is thus 65 to 545 pF and on long waves 90 to 570 pF. With R.F. coils of 170  $\mu$ H the medium range is 200—570 m, whilst coils of 2150  $\mu$ H give 830—2090 m in the long wave range.

The oscillator circuit is coupled to the first grid of the DK 21, this conventional battery circuit being selected in view of the limited mutual conductance of the oscillator unit in the mixer valve. Condenser  $C_{15}$ , the grid condenser, is of 47 pF, as this is the most suitable for satisfactory oscillation on long waves, combined with a minimum of frequency drift on the short waves. The padding condensers are of the fixed type, with trimmers in parallel for accurate adjustment of the capacitance.

### *Frequency-changer*

The oscillator voltage, as measured at the first grid of the DK 21 should be about 9 V<sub>eff</sub> (200  $\mu$ A at  $R_7$ ). As already stated, the frequency-changer is controlled by the A.G.C. in the medium and long wave ranges, but not on short waves. The conversion gain factor is approximately 56.

### *I.F. circuits*

The intermediate frequency is 470 kc/s. The I.F. transformers are of the iron-cored



type and self-inductance is approx. 1 mH. To ensure that the R.F. circuit quality shall be as high as possible, the condensers in the I.F. circuit should be of the highest grade (Philips "button" condensers); the value of these is 100 pF. The I.F. circuits are trimmed to the required frequency by adjustment of the self-inductance (iron cores).

#### I.F. valve

The I.F. valve is a DF 22 and this is included in the automatic gain control in all wave ranges. Without control applied to the valve, the grid bias is provided by the voltage drop between the filaments of the DK 21 and DF 22, this being 1.4 V. The I.F. gain factor is approximately 50.

#### Detector, A.G.C. and A.F. amplifier

Diode anode  $d_1$  of the DBC 21 valve is employed for the detection, and  $d_2$  for the automatic gain control. The delay voltage of  $-4.2$  V for the latter is obtained from the potential difference between the filaments of the DK 21, DF 22 and DBC 21, and chassis. (The A.G.C. diode is mounted at the positive end of the filament of the DBC 21.) Without control the grid bias values of the DK 21 and DF 22 are 0 V and  $-1.4$  V respectively. The A.F. voltage is tapped from the volume control  $R_{10}$  and is applied to the grid of the DBC 21 across condenser  $C_{22}$ . To avoid ripple when the set is working from the mains, the anode voltage is taken from a filter,  $R_{13}-C_{24}$ .

#### Gramophone pickup socket

Voltage from the gramophone pickup is applied to the volume control  $R_{10}$  across condensers  $C_{19}$  and  $C_{23}$ . The resistance  $R_9$  is included in series with the volume control to prevent the diode  $d_1$  from being connected in parallel with the pickup.

#### Output stage

The output valve is a DL 21. Grid bias for this valve is obtained when operating on mains by means of a resistance  $R_{13}$  and when on batteries by  $R_{18}$  and  $R_{19}$ . The DL 21 is capable of giving an output of 170 mW.

#### Filament and anode feed

The four receiving valves are connected in a certain sequence, both for mains and for battery operation, and this sequence is: —L.T. battery—DL 21—chassis—DK 21—DF 22—DBC 21— +L.T. The differences in potential occurring between the different filaments and the chassis due to this series connection is utilised as grid bias for the DF 22 and DBC 21, the same circuit also supplying the delay voltage for the automatic gain control. If, instead of the DF 22 and DBC 21, the parallel-coupled DF 21 and

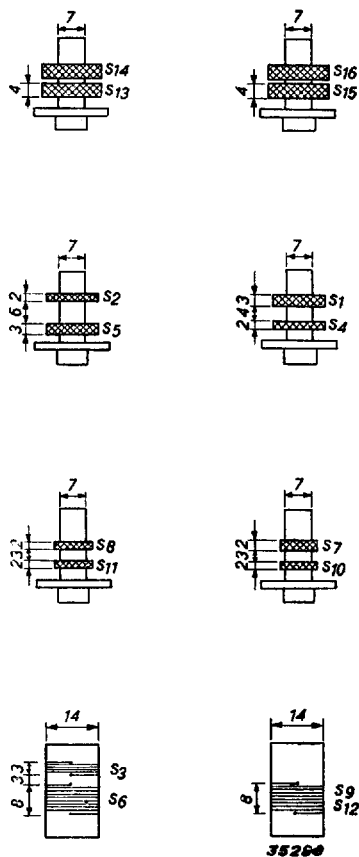

Fig. 2  
Coils used in the circuit shown in Fig. 1.

TABLE OF COILS

Coil	No. of turns.	Self-inductance.	Type of winding	Diam. of former in mm	Wire thickness in mm	Wire
$S_1$	950	—	wave	7	0.07	enamelled
$S_2$	319	—	wave	7	0.1	"
$S_3$	23	—	layer	14	0.1	"
$S_4$	366	2150 $\mu$ H	wave	7	0.1	"
$S_5$	97	160 $\mu$ H	wave	7	15 $\times$ 0.04	litz
$S_6$	10	—	layer	14	1	enamelled
$S_7$	100	—	wave	7	0.1	"
$S_8$	50	—	wave	7	0.1	"
$S_9$	7	—	layer	14	0.1	"
$S_{10}$	128	320 $\mu$ H	wave	7	0.1	"
$S_{11}$	60	75 $\mu$ H	wave	7	0.1	"
$S_{12}$	9	—	layer	14	1	"
$S_{13}$	2 $\times$ 155	1 mH	wave	7 mm iron core	24 $\times$ 0.04	litz
$S_{14}$ *						
$S_{15}$						
$S_{16}$						

\*) Spacing  $S_{13}-S_{14}$  } 36 mm  
 $S_{15}-S_{16}$  }

DAC 21 are employed, a certain amount of battery current can be saved, but the circuit is rather more complicated and the filament battery is then of a non-standard voltage. As already mentioned, grid bias for the DL 21 is obtained in a different manner, namely by means of  $R_{18}$  when on mains and  $R_{18}$ ,  $R_{19}$  on battery feed. If the output valve were to be biased by the potential difference between filaments, special measures would have to be taken to avoid interference such as motor-boating, whistles, etc. Coupling between the output valve and the other valves should be limited as much as possible, for which reason the chassis is not connected to the extreme negative end of the filament circuit, but to the junction of the DK 21 and DL 21.

*Mains operation*

A resistance to safeguard the UY 1 is not necessary, since the capacitance of the electrolytic condenser  $C_3$  immediately following the rectifier is only 16  $\mu$ F. To obtain the maximum permissible anode voltage (120 V) when the receiver is working on 220 V mains, the anode feed is tapped from the junction of  $R_3$  and  $R_4$ . When 110 V mains are used a voltage drop occurs across  $R_4$ , but as this is only roughly 5 V it is not worth while fitting a special switch to interconnect with the junction of the choke and  $R_3$ .

*Battery operation*

The maximum permissible battery voltage is 120 V, but quite satisfactory results are obtained on an anode voltage of 90 V. The maximum anode current of the receiver is only 8 mA and the total filament current is 50 mA at 6 V.

### *Switches in the feed section*

In the feed section there are in all seven switches, of which A and B are the mains on-off switches and C—D the battery on-off: switch E operates the change-over from mains to battery and vice versa. To protect the battery it is advisable to arrange the switching so that:

- 1) the mains cannot be applied when operating on batteries,
- 2) the battery cannot be connected when the set is working on the mains,
- 3) switch E is always at the correct setting for mains or battery operation.

It is quite practicable to arrange for automatic switching from battery to mains, for instance by means of a relay.

Another fool-proof solution is to employ 8 sockets at the points numbered 1 to 7 in the circuit diagram (see figure at the foot of the main circuit). The pins of a four-pin plug are shorted in pairs and the plug is inserted in the upper 4 sockets for mains operation, or the lower 4 sockets when the set is to work on batteries. In the first instance points 1 and 2, 3 and 4 are short-circuited; in the second case points 6 and 7, 3 and 5.

Switches *F* and *G* serve to connect the receiver either for 110 V or 220 V mains and the different resistance values indicated in the circuit diagram have been selected to give optimum results on both of these mains voltages.

## VIII. 2-Valve battery receiver for use with headphones

*Valves used:* DAH 50, DAH 50.

*Batteries:* 15 V anode battery and 1.4 V filament battery. The total anode current of the receiver is about 6 mA and the filament current 75 mA.

*Wave range:* 200—600 m.

### *Description*

This is a two-valve, battery-operated receiver with 2 tuned circuits and reflex A.F. circuit. Although the anode voltage is only 15 V, the sensitivity is high, viz.  $30 \mu\text{V}$ . This sensitivity is based on an input signal such that the output voltage is just sufficient for satisfactory reception by means of headphones, and the appropriate A.F. voltage on the grid of the output valve is only 0.025 V (approx.). The sensitivity referred to enables the listener to receive a very large number of broadcast stations, even when only a few yards of wire are used as aerial. No filter circuits are incorporated, so that the cost and dimensions of the receiver may be kept at a minimum.

### *Coils*

The aerial coupling is inductive and guarantees a constant voltage gain factor of 2 throughout the whole wave range. The self-inductance of the tuning coil is adjusted to the correct value with shorted aerial coil and the increase in the self-inductance is measured when this short-circuit is removed, thus giving an indication of whether the coupling between the aerial and tuning coils is sufficient to ensure the specified voltage gain. When the short-circuit is taken from the aerial coil, the self-inductance of the tuning coil should show an increase of 3 %.

### *R.F. amplification*

The inclusion of an R.F. amplification stage makes it possible for one valve to do the work of two (reflex circuit). R.F. amplification in place of possible extra A.F. ampli-

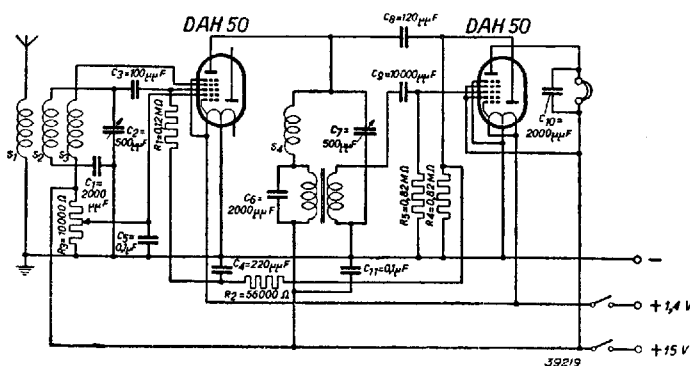

Fig. 1  
Circuit diagram of 2-valve battery receiver for a maximum anode feed of 15 V.  
(Published without any guarantees in respect of patent rights.)

cation is, at the same time, essential to ensure the correct balance between selectivity and sensitivity, and for this purpose reaction is employed. This R.F. reaction is provided by a fixed reaction coil consisting of 15 turns of wire, between the 4th grid of the first DAH 50 and the 15 V anode voltage, and the coupling between this and the tuning



coil is not variable. A potentiometer of 10,000 ohms between the 2nd grid and the filament is employed to control the slope of the valve and, with it, the amount of reaction; the coupling between the coils is so adjusted that the receiver just commences to oscillate at the upper end of the wave-range (800 m), with 15 V on the second grid. The starting point of the oscillation throughout the whole range may be regulated by reducing this voltage, and the point where oscillation commences can thus be ensured from one end of the scale to the other. The great advantage of this type of control through the variations in mutual conductance is that any tendency towards parasitic oscillation due to unwanted coupling arising from the anode-to-grid capacitance is suppressed. Since reaction is applied in the first circuit, there is a possibility of radiation from the aerial when the set oscillates, but the power involved is so small that it may be ignored. The diode of the first DAH 50 is not used and the split filament serving the two units in the valve effects a saving in filament current, in that the portion operating the diode is not used either.

### Detection

Detection takes place at the diode of the output valve.

### A.F. amplification

The first DAH 50 is employed both as R.F. and A.F. amplifier; the R.F. signal, detected by the diode in this reflex circuit, is applied through the R.F. filter  $R_2-C_4$  (with grid

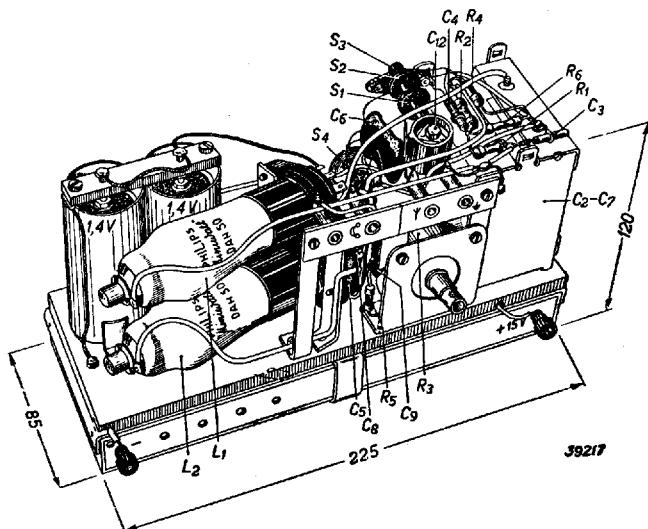

Fig. 2  
Drawing of a set with two DAH 50 valves.

leak  $R_1$ ) to the control grid of the first valve. If preferred, of course, a volume control can be used in place of the fixed resistance  $R_4$ , in which case the reaction can be adjusted to give optimum selectivity in each case. To avoid short-circuiting of the A.F. signal in the input circuit, a small blocking condenser  $C_3$  is provided. An A.F. transformer is placed in series with the anode circuit of the first valve (ratio 1 : 3). Condenser  $C_6$  serves to prevent the primary winding of the A.F. transformer from forming an impedance in the tuned circuit and to avoid R.F. voltages on the control grid of the output

valve: this condenser naturally affects the tuning of the second circuit and, to ensure proper alignment between the 1st and 2nd circuits, a condenser  $C_1$  of 2000 pF is also included in the former. Obviously condensers  $C_1$  and  $C_6$  must be of the same value.

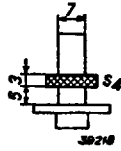
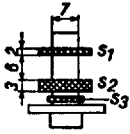

Fig. 3  
Sketches of the coils

The A.F. voltage on the secondary side of the A.F. transformer is applied to the control grid of the output valve through a condenser  $C_9$  which, together with  $R_6$ , provides automatic bias for this valve in the event of grid current flowing. Distortion is not fully eliminated in this manner, but grid current distortion is replaced by the less unpleasant distortion caused by curvature in the characteristic.

Fig. 2 shows a method of construction that will keep the dimensions of the receiver at a minimum. Sizes are given in millimetres.

TABLE OF COILS

Coil	No. of turns	Type of winding	diameter of former in mm	Wire thickness in mm	Type of wire
$S_1$	319	wave	7	0.1	enamelled
$S_2$	97	wave	7	$15 \times 0.04$	litz
$S_3$	15	wave	7	0.1	enamelled
$S_4$	97	wave	7	$15 \times 0.04$	litz

**100 mA Valves**  
**for AC/DC receivers**

## 100 mA valves for AC/DC receivers

The valves originally employed in AC/DC receivers (C and E types) consumed a heater current of 200 mA and this represented a definite obstacle to the construction of the cheaper type of low-consumption receiver. Towards the close of 1939, a range of valves was therefore developed of which the heater current was only one half of the former value in this class of "U-valve", that is, only 100 mA.

The advantages of such a reduction in heater current have already been described in the chapter on the AC/DC "all-glass" valves and it will now be sufficient to summarise in brief the different types. The functions of these valves are based on the standardisation as described on page 8, and the range under review thus includes only 3 receiving valves, an electronic indicator and a rectifier.

Type	Function	Heater voltage
UBL 1	Double diode O.P. pentode	55 V
UCH 4	Triode heptode	20 V
UF 9	Variable mu R.F. pentode	12.6 V
UM 4	Electronic indicator	12.6 V
UY 1 (N)	Half-wave rectifier	50 V

All these valves have the 8-pin base with pilot pin. Data and characteristics will be found in the following pages, but since the different types in this series correspond to those in the new U-type of "all-glass" valve, reference may be made to the description of these (pp. 33 et seq.) for details of the construction and application.

# UBL 1 Double diode output pentode

The UBL 1 is a double diode output pentode of high mutual conductance (at  $V_a = 200$  V,  $S = 8.5$  mA/V). A common cathode serves both units of the valve, in which the diodes are mounted below the pentode, both at the same level; the two diodes are therefore equal in value and for practical purposes it is immaterial which of them is employed for detection. The connection of the grid of the pentode is situated at the top of the valve to avoid any possible interaction between the diode and the pentode sections. With a view to possible hum, the A.F. sensitivity at the detector diode should not be more than about 24 mV, with the volume control at maximum strength. If negative feed-back is employed the gain factor between the detector diode and the grid of the output valve may if necessary exceed 15, but only provided that negative feed-back is such that the sensitivity value given above is not exceeded.

The screen grid voltage may be the same as the anode voltage, with consequent simplification of the circuit; there is then no screen grid resistance to be short-circuited in cases where a 220 V receiver is to be switched over for 100 and 127 V mains. Special care has been taken in connection with the optimum output to be obtained from this valve on a low working voltage, this being about 1 W with 7 % distortion, at an anode and screen grid voltage of 100 V.



Fig. 1  
Dimensions in mm

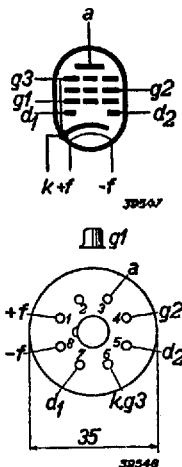

Fig. 2  
Arrangement of electrodes and contacts

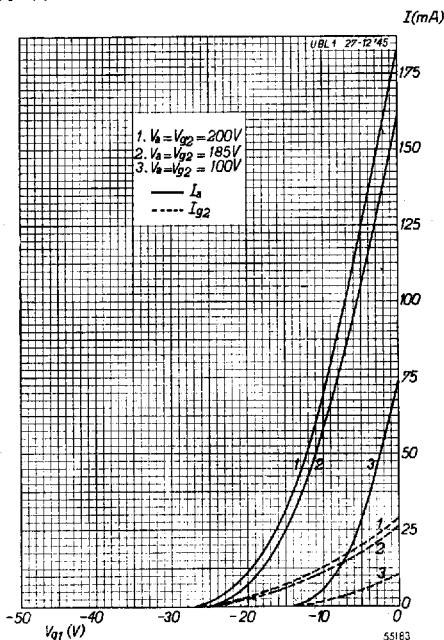

Fig. 3  
Anode and screen grid current as a function of the grid bias at  $V_a = V_{g2} = 200$  V, 185 V and 100 V.

## HEATER RATINGS

Heater feed: indirect by AC or DC: series supply.

Heater voltage . . .  $V_f = 55$  V

Heater current . . .  $I_f = 0.100$  A

## CAPACITIES

Pentode section:  $C_{ag1} < 0.8$  pF

Diode section:  $C_{d1k} = 4.8$  pF

$C_{d2k} = 4.6$  pF

$C_{d1d2} < 0.08$  pF

# UBL 1

Between diode and pentode	$C_{d1a}$	< 0.08 pF
	$C_{d2a}$	< 0.08 pF
	$C_{d1g1}$	< 0.05 pF
	$C_{d2g1}$	< 0.05 pF
	$C_{(d1 + d2)g1}$	< 0.1 pF
	$C_{(d1 + d2)a}$	< 0.25 pF

## OPERATING DATA FOR THE PENTODE SECTION when used as single output valve

Anode voltage . . . . .	$V_a$	=	100	185	200	200	V
Screen grid voltage . . . . .	$V_{g2}$	=	100	185	200	200	V
Cathode resistance . . . . .	$R_k$	=	145	140	240	175	Ohms
Grid bias . . . . .	$V_{g1}$	=	-5	-10	-13	-11.5	V
Anode current . . . . .	$I_a$	=	28.5	59	45	55	mA
Screen grid current . . . . .	$I_{g2}$	=	5.25	11.3	9	11	mA
Mutual conductance . . . . .	$S$	=	7	8.8	7.5	8.5	mA/V
Internal resistance . . . . .	$R_i$	=	25,000	23,000	28,000	20,000	Ohms
Gain factor with respect to screen grid . . . . .	$\mu_{g2g1}$	=	11	11	11	11	
Optimum load resistance . . . . .	$R_a$	=	3000	3000	4500	3500	Ohms
Output power . . . . .	$W_o$	=	1.05	5	4	5.2	Watts
Total distortion . . . . .	$d_{tot}$	=	6.8	10	10	10	%
Alternating grid voltage . . . . .	$V_i$	=	3.3	7	6.4	7	$V_{eff}$
Sensitivity $V_i (W_o = 50 \text{ mW})$		=	0.6	0.5	0.5	0.5	$V_{eff}$

## MAXIMUM RATINGS (Pentode section)

$V_a (I_a = 0)$	= max. 550 V	$W_{g2} (W_o = \text{max.})$	= max. 4.0 W
$V_a$	= max. 250 V	$I_k$	= max. 70 mA
$W_a$	= max. 11 W	$V_{g1} (I_{g1} = + 0.3 \mu\text{A})$	= max. -1.3 V
$V_{g2} (I_{g2} = 0)$	= max. 550 V	$R_{g1k}$	= max. 1 MOhm
$V_{g2}$	= max. 250 V	$R_{fk}$	= max. 20,000 Ohms
$W_{g2} (V_i = 0)$	= max. 2.5 W	$V_{fk}$	= max. 150 V

### Diode section:

$V_{d1} = V_{d2}$	= max. 200 V	$V_{d1} (I_{d1} = + 0.3 \mu\text{A})$	= max. -1.3 V
$I_{d1} = I_{d2}$	= max. 0.8 mA	$V_{d2} (I_{d2} = + 0.3 \mu\text{A})$	= max. -1.3 V

Grid bias must be obtained by means of a cathode resistance only. So-called semi-automatic bias may be employed only when the cathode current of this valve is in excess of 50 % of the total current passing through the resistance producing this potential.

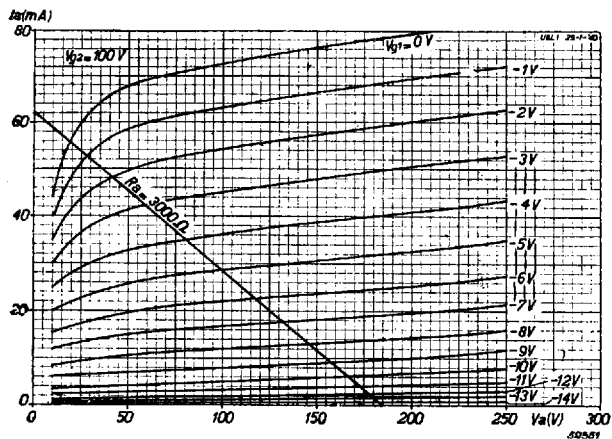

Fig. 4  
Anode current as a function of anode voltage at  $V_{g2} = 100V$ , with  $V_{g1}$ , as parameter.

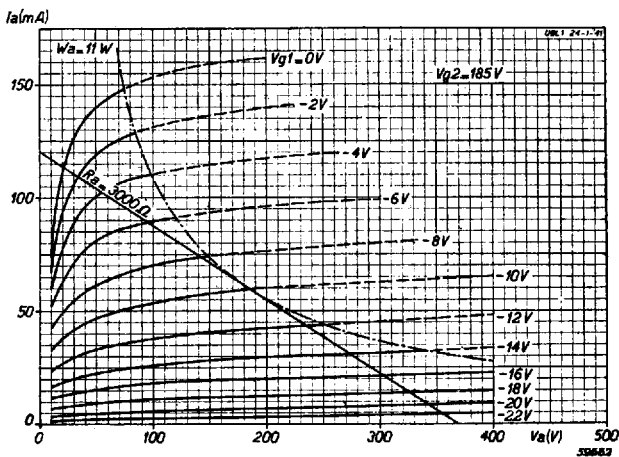

Fig. 5  
Anode current as a function of anode voltage at  $V_{g2} = 185V$ , with  $V_{g1}$ , as parameter.

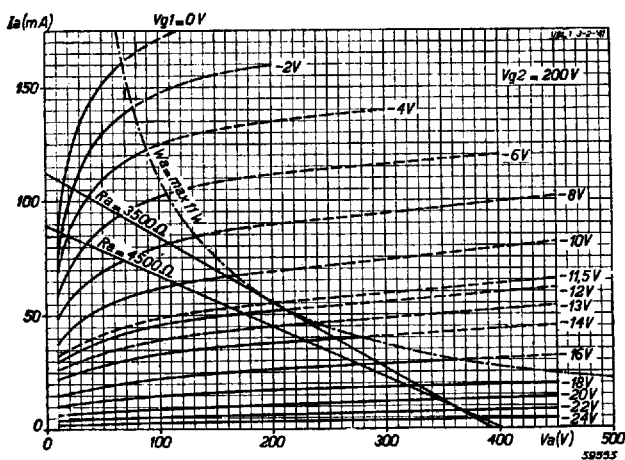

Fig. 6  
Anode current as a function of anode voltage at  $V_{g2} = 200V$ , with  $V_{g1}$ , as parameter. The load lines for 9 W ( $R_a = 4500 \Omega$ ) and 11 W ( $R_a = 3500 \Omega$ ) operation are also shown.

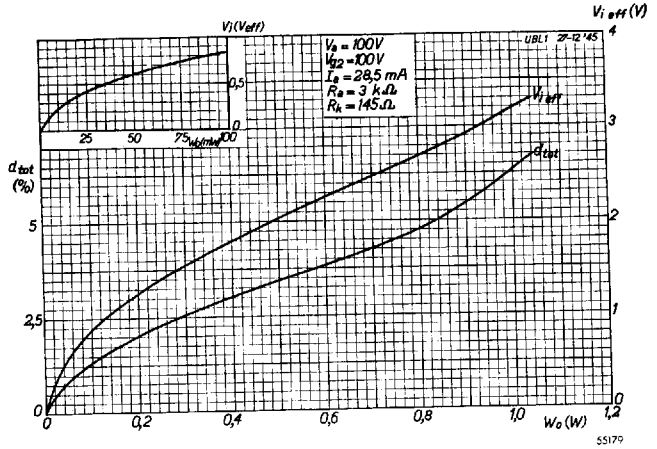

Fig. 7. Total distortion and alternating grid voltage as a function of output power at  $V_a = V_{g2} = 100$  V.

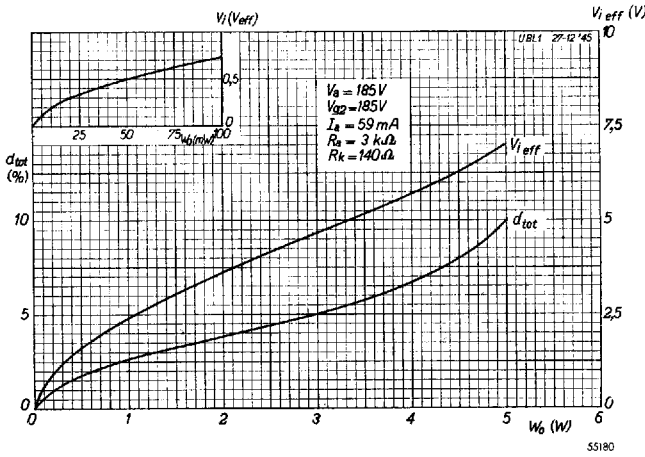

Fig. 8. Total distortion and alternating grid voltage as a function of output power at  $V_a = V_{g2} = 185$  V.

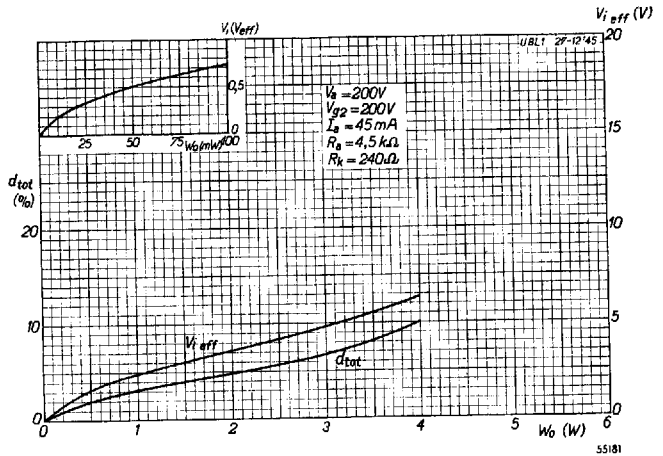

Fig. 9. Total distortion and alternating grid voltage as a function of output power at  $V_a = V_{g2} = 200$  V, for 9 W operation



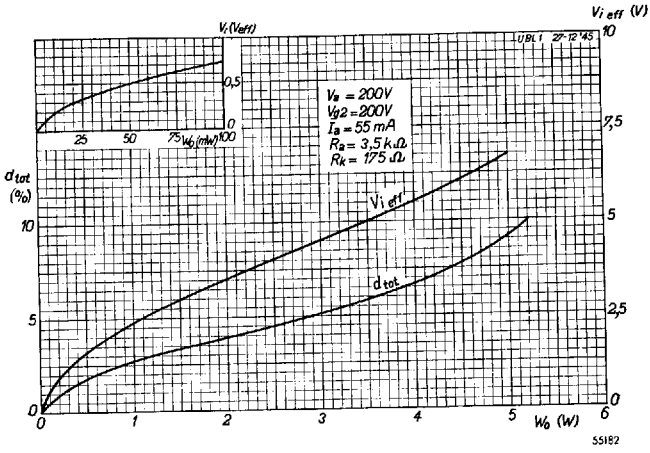

Fig. 10  
 Total distortion and alternating grid voltage as a function of output power at  $V_a = V_{g_2} = 200$  V, for 11 W operation.

# UCH 4 Triode-heptode

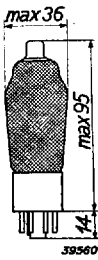

Fig. 1  
Dimensions in mm.

The UCH 4 is a triode-heptode the characteristics of which correspond almost entirely to those of the UCH 21, and reference should be made to the description of that valve. In the UCH 4, too, the triode grid and the third grid of the heptode are quite separate, with individual outside connection, making the valve systems suitable for various functions, such as:

- 1) mixer valve;
- 2) combined I.F. and A.F. amplifier;
- 3) A.F. amplifier and phase inverter.

In the following pages the operating data and characteristics are given in reference to these three types of application.

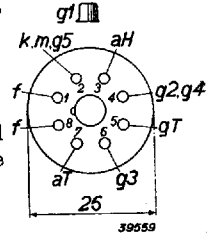
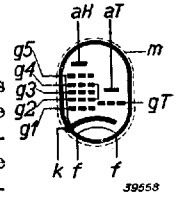

Fig. 2.  
Arrangement of electrodes and contacts.

### HEATER RATINGS

Heater feed: indirect by AC or DC; series supply.

Heater voltage . . . . .  $V_f = 20$  V

Heater current . . . . .  $I_f = 0.100$  A

### CAPACITIES

Heptode section:	$C_{g1}$	= 4.8 pF	$C_{g1g2}$	< 0.2 pF
	$C_a$	= 8.0 pF	$C_{g2}$	= 9.1 pF
	$C_{g1}$	< 0.002 pF	$C_{g1f}$	< 0.0015 pF
Triode section:	$C_g$	= 5.9 pF	$C_{ak}$	= 2.4 pF
	$C_a$	= 5.2 pF	$C_{ag}$	= 2.1 pF
	$C_{gk}$	= 2.8 pF	$C_{gf}$	< 0.3 pF

Between heptode and triode:

$C_{gTg1H}$	< 0.1 pF	$C_{(gT+g3)g1H}$	< 0.25 pF
$C_{(gT+g3)}$	= 13.8 pF	$C_{(gT+g3)aH}$	< 0.1 pF

### OPERATING DATA FOR THE HEPTODE SECTION when used as mixer valve

Third grid connected to triode grid, sliding screen grid voltage

Anode and supply voltage $V_a = V_b$	=	100 V	200 V
Screen grid resistance . . . $R_{(g2+g4)}$	=	15,500 Ohms	15,500 Ohms
Cathode resistance . . . $R_k$	=	150 Ohms	150 Ohms
Grid leak: third and triode grids . . . . . $R_{(gT+g3)}$	=	50,000 Ohms	50,000 Ohms
Current to third and triode grids . . . . . $I_{(gT+g3)}$	=	95 $\mu$ A	190 $\mu$ A
Grid bias . . . . . $V_{g1}$	=	$-1^1$ $-13.5^2$	$-2^1$ $-26.5^2$ V
Screen grid voltage . . . $V_{(g2+g4)}$	=	53    100	100    200 V
Anode current . . . . . $I_a$	=	1.5    —	3.0    — mA
Screen grid current . . . $I_{(g2+g4)}$	=	3.0    —	6.5    — mA
Conversion conductance . . $S_c$	=	600    6.0	750    7.5 $\mu$ A/V
Internal resistance . . . $R_i$	=	1.0    > 10	1.3    > 10 M Ohm
Equivalent noise resistance $R_{eq}$	=	40,000    —	55,000    — Ohms

**OPERATING DATA FOR THE HEPTODE SECTION when used as I. F. amplifier**

Third grid not connected to triode grid; sliding screen grid voltage.

Anode and supply voltage . . . . .	$V_a = V_b =$	100 V	200 V			
Third grid voltage	$V_{g3} =$	0 V	0 V			
Screen grid resistance . . . . .	$R_{(g2+g4)} =$	30,000 Ohms	30,000 Ohms			
Grid bias . . . . .	$V_{g1} =$	$\overbrace{-1.0^1) \quad -13^2) \quad -18^3)}$	$\overbrace{-2.0^1) \quad -27^2) \quad -35^3)}$	V		
Screengrid voltage	$V_{(g2+g4)} =$	50	98	94	200	V
Anode current . . . . .	$I_a =$	2.6	—	5.2	—	mA
Screengrid current	$I_{(g2+g4)} =$	1.9	—	3.5	—	mA
Mutual conductance . . . . .	$S =$	2100	21	2.1	2200	22
Internal resistance . . . . .	$R_i =$	0.7	>10	>10	0.7	>10
Gain factor in respect of the screen	$\mu_{g2g1} =$	18	—	—	18	—
Equivalent noise resistance . . . . .	$R_{eq} =$	4900	—	—	9000	—
						Ohms

<sup>1)</sup> Valve not controlled.  
<sup>2)</sup> Mutual or conversion conductance controlled to 1/100.  
<sup>3)</sup> Mutual or conversion conductance controlled to 1/1000.

**TRIODE RATINGS**

Anode voltage . . . . .	$V_a =$	100 V
Grid bias . . . . .	$V_g =$	0 V
Anode current . . . . .	$I_a =$	12 mA
Mutual conductance . . . . .	$S =$	3.2 mA/V
Gain factor . . . . .	$\mu =$	22

**OPERATING DATA FOR THE TRIODE SECTION when used as oscillator valve**

Supply voltage . . . . .	$V_b =$	100 V	200 V
Anode resistance . . . . .	$R_a =$	20,000 Ohms	20,000 Ohms
Anode voltage . . . . .	$V_a =$	62 V	116 V
Grid leak . . . . .	$R_{(gT+g3)} =$	50,000 Ohms	50,000 Ohms
Current passing through grid leak during oscillation . . . . .	$I_{(gT+g3)} =$	95 $\mu$ A	190 $\mu$ A
Anode current during oscillation . . . . .	$I_a =$	1.9 mA	4.1 mA
Effective mutual conductance . . . . .	$S_{eff} =$	0.44 mA/V	0.45 mA/V

**OPERATING DATA FOR THE TRIODE SECTION when used as A.F. amplifier**

Supply voltage $V_b$ (V)	Anode resistance $R_a$ (MOhm)	Anode current $I_a$ (mA)	Grid bias $V_g$ (V)	Gain factor $\frac{V_{o\ eff}}{V_{i\ eff}}$ —	Alternating output voltage $V_{o\ eff}$ (V)	Total distortion $d_{tot}$ (%)
200	0.2	0.8	—2	10	7.5	2.8
100	0.2	0.37	—1	10	7.5	6.0
200	0.1	1.5	—2	10.5	7.5	2.8
100	0.1	0.68	—1	10.5	7.5	5.8
200	0.05	2.8	—2	11	7.5	2.2
100	0.05	1.3	—1	11	7.5	5.4

**OPERATING DATA: valve employed as phase inverter for modulation of a push-pull output stage**

(With feedback, see Fig. 16).

Supply voltage . . . . .	$V_b$	= 200 V	200 V	100 V	100 V
Anode resistance; heptode section . . . . .	$R_{aH}$	= 0.2	0.1	0.2	0.1 MOhm
Anode resistance; triode section . . . . .	$R_{aT}$	= 0.1	0.1	0.1	0.1 MOhm
Screen grid resistance . . .	$R_{(g_2 + g_4)}$	= 0.18	0.1	0.18	0.1 MOhm
Total anode current: triode and heptode . . . . .	$I_{aH} + I_{aT}$	= 2.1	2.7	1.1	1.3 mA
Screen grid current . . . .	$I_{(g_2 + g_4)}$	= 0.8	1.3	0.4	0.65 mA
Cathode resistance . . . .	$R_k$	= 700	500	700	500 Ohms
Voltage gain . . . . .	$\frac{V_{o\ eff}}{V_{i\ eff}}$	= 75	70	65	55
Alternating output voltage	$V_{o\ eff}$	= 10	10	10	10 V
Alternating input voltage .	$V_{i\ eff}$	= 0.13	0.14	0.155	0.18 V
Total distortion . . . . .	$d_{tot}$	= 2.5	2.3	3.1	2.4 %

**MAXIMUM RATINGS FOR THE HEPTODE SECTION**

Anode voltage in cold condition . . . . .	$V_{a0}$	= max. 550 V
Anode voltage . . . . .	$V_a$	= max. 250 V
Anode dissipation . . . . .	$W_a$	= max. 1.5 W
Screen grid voltage, cold . . . . .	$V_{(g_2 + g_4)0}$	= max. 550 V
Screen grid voltage, valve uncontrolled ( $I_a = 3$ mA)	$V_{(g_2 + g_4)}$	= max. 100 V
Screen grid voltage, valve controlled ( $I_a < 1$ mA)	$V_{(g_2 + g_4)}$	= max. 250 V
Screen grid dissipation . . . . .	$W_{(g_2 + g_4)}$	= max. 1 W
Cathode current . . . . .	$I_k$	= max. 15 mA
Grid current commences at ( $I_{g1} = +0.3$ $\mu$ A) . .	$V_{g1}$	= max. —1.3 V
Grid current commences at ( $I_{g3} = +0.3$ $\mu$ A) . .	$V_{g3}$	= max. —1.3 V
Max. external resistance between grid 1 and cathode . . . . .	$R_{g1k}$	= max. 3 MOhm
Max. external resistance between grid 3 and cathode . . . . .	$R_{g3k}$	= max. 3 MOhm
Max. external resistance between filament and cathode . . . . .	$R_{fk}$	= max. 20,000 Ohms
Max. voltage between filament and cathode (D.C. or effective value of A.C.) . . . . .	$V_{fk}$	= max. 150 V

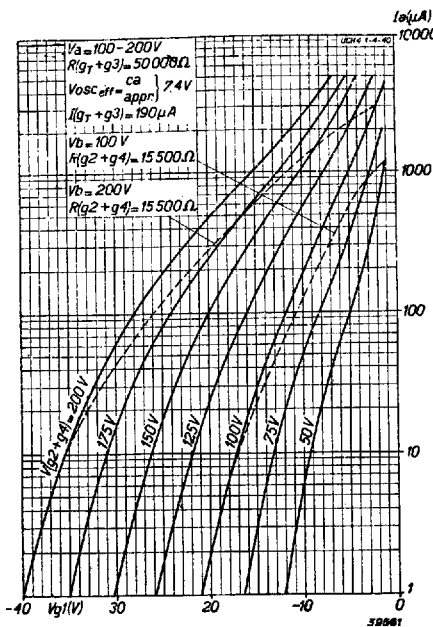

Fig. 3  
Anode current as a function of grid bias at  $V_a = 100-200V$ ,  $R(g_T + g_s) = 50,000$  Ohms,  $I(g_T + g_s) = 190$   $\mu A$ , with  $V(g_s + g_a)$  as parameter.

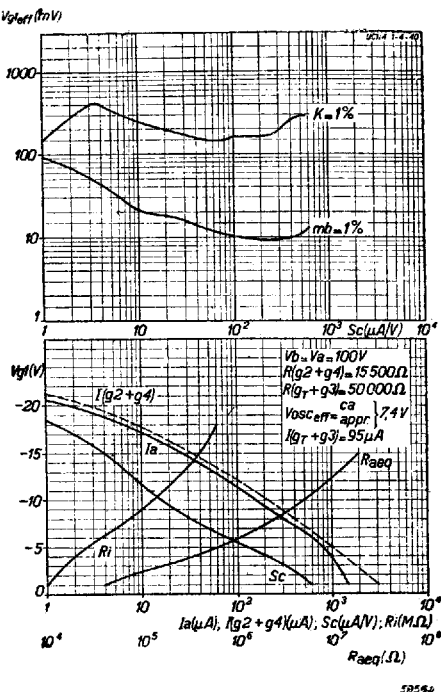
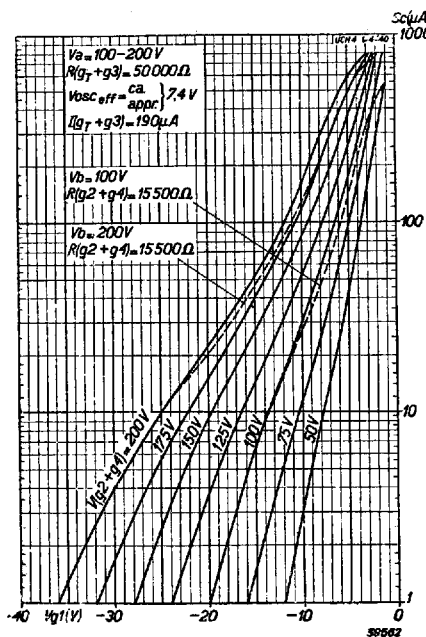

Fig. 5  
Upper diagram; Maximum permissible effective value of R.F. alternating voltage at 1% cross modulation ( $K = 1\%$ ) and also for 1% modulation hum ( $mb = 1\%$ ), both in respect of the interfering signal at the grid, as a function of conversion conductance. Screen grid fed through a resistance of 15,500 ohms from the 100 V line.  
Lower diagram; Conversion conductance  $Sc$ , anode current  $I_a$ , screen grid current  $I$  ( $g_s + g_a$ ), internal resistance  $R_i$  and equivalent noise resistance  $R_{aeg}$  as a function of grid bias.



**MAXIMUM RATINGS FOR THE TRIODE SECTION**

- Anode voltage in cold condition  $V_{a0} = \text{max. } 550V$
- Anode voltage  $V_a = \text{max. } 100V$
- Anode dissipation  $W_a = \text{max. } 0.5W$
- Grid current commences at ( $I_g = +0.3 \mu A$ )  $V_g = \text{max. } -1.3V$
- Maximum external resistance in grid circuit  $R_{gk} = \text{max. } 3M\Omega$

Fig. 4  
Conversion conductance as a function of the grid bias at  $V_a = 100-200V$ ,  $R(g_T + g_s) = 50,000$  Ohms,  $I(g_T + g_s) = 190\mu A$ , with  $V(g_s + g_a)$  as parameter.

UCH 4

$R_{eq}(\Omega) \times 10^3$   
 $Sc(\mu A/V)$

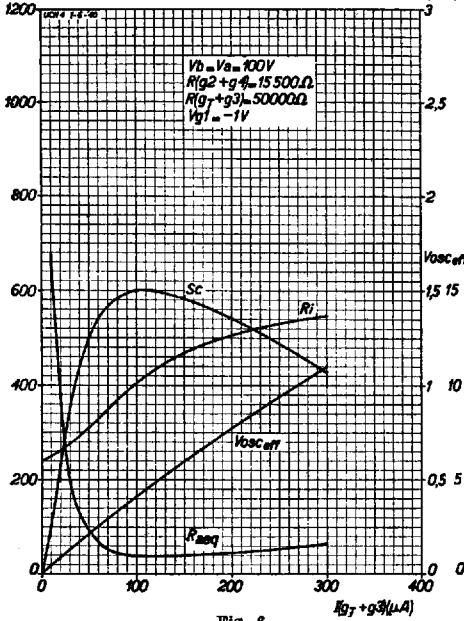

Fig. 6  
38533

Conversion conductance, internal resistance, alternating oscillator voltage and equivalent noise resistance as a function of oscillator current, with screen grid fed through a 15,500 Ohm resistance from 100 V, at  $Vg_1 = -1 V$ .

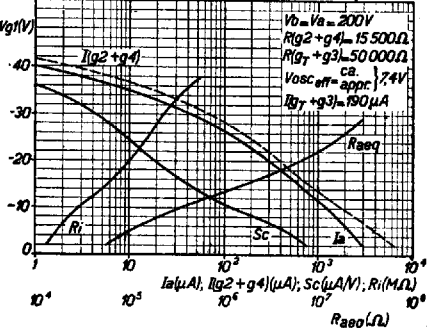
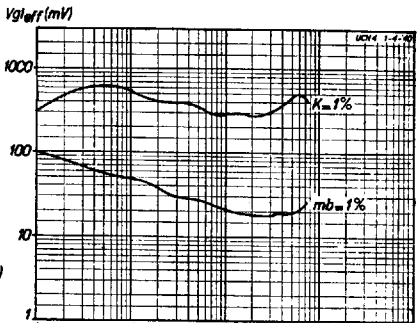

Fig. 7

Upper diagram; Maximum permissible effective value of R.F. alternating voltage at 1% cross modulation ( $K = 1\%$ ) and also at 1% modulation hum ( $mb = 1\%$ ), both in respect of the interfering signal at the grid, as a function of conversion conductance, with screen grid fed through a resistance of 15,500 ohms from the 200 V line.

Lower diagram; Conversion conductance  $Sc$ , screen grid current  $I(g_3 + g_4)$ , internal resistance  $Ri$  and equivalent noise resistance  $R_{eq}$  as a function of grid bias.

$R_{eq}(\Omega) \times 10^3$   
 $Sc(\mu A/V)$

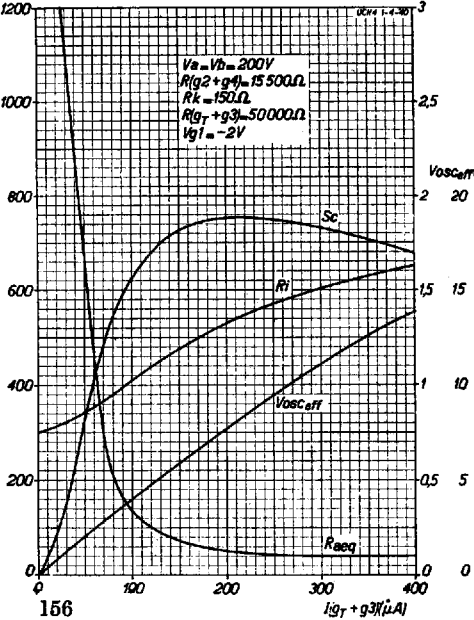

Fig. 8

Conversion conductance, alternating oscillator voltage and equivalent noise resistance as a function of oscillator current, with screen grid fed through a 15,500 ohm resistance from the 200 V line, at  $Vg_1 = -2 V$

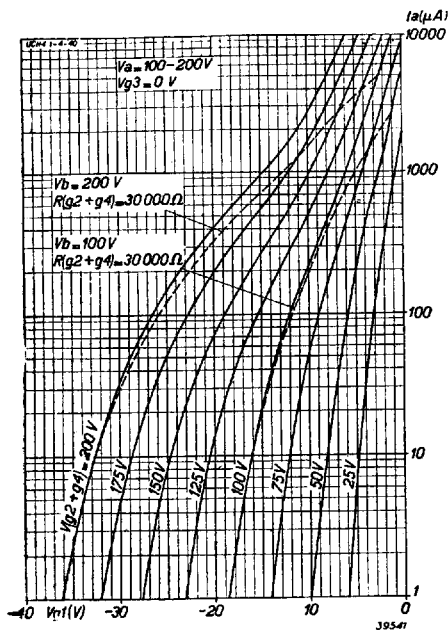

Fig. 9.

Anode current of the heptode section used as I.F. amplifier, as a function of grid bias, at  $V_a = 100-200V$ ,  $V_{g_3} = 0V$  and screen grid fed through a 30,000 ohm resistance, with  $V(g_2 + g_4)$  as parameter.

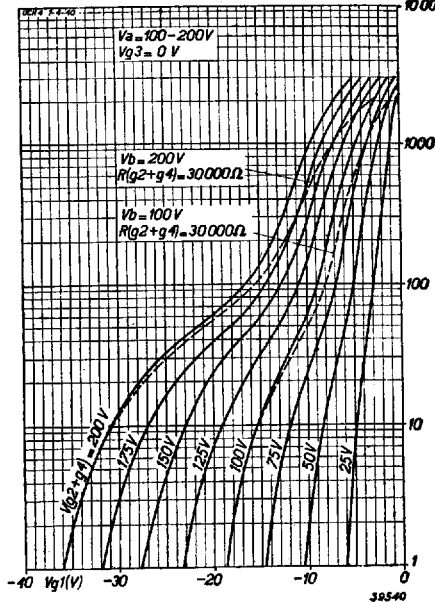

Fig. 10

Mutual conductance of the heptode section as a function of grid bias at  $V_a = 100-200V$ ,  $V_{g_3} = 0V$  and screen grid fed through a 30,000 ohm resistance, with  $V(g_2 + g_4)$  as parameter.

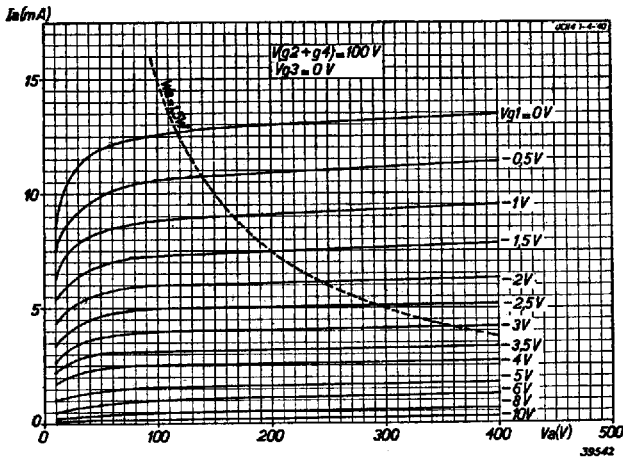

Fig. 11

Anode current as a function of anode voltage at  $V(g_2 + g_4) = 100V$  and  $V_{g_3} = 0V$ , with grid bias as parameter.

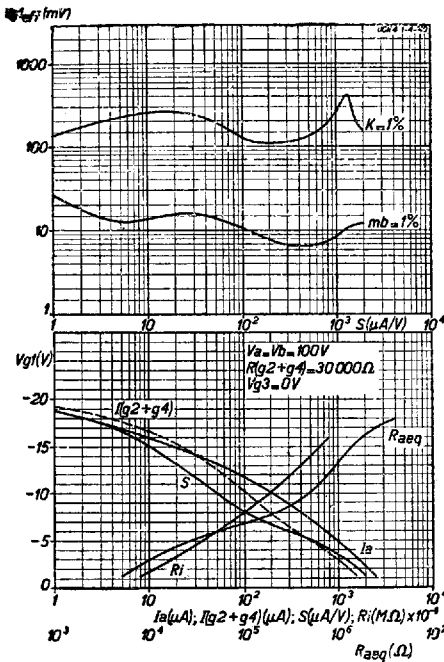

Fig. 12

Upper diagram; Maximum permissible effective value of R.F. alternating voltage at 1% cross modulation ( $K = 1\%$ ) and also at 1% modulation hum ( $mb = 1\%$ ), both in respect of the interfering signal at the grid, as a function of grid bias, with screen grid fed through a 30,000 ohm resistance from the 100 V line. Lower diagram; Mutual conductance  $S$ , anode current  $I_a$ , screen grid current  $I(g_2 + g_4)$ , internal resistance  $R_i$  and equivalent noise resistance  $R_{aeq}$  as a function of grid bias.

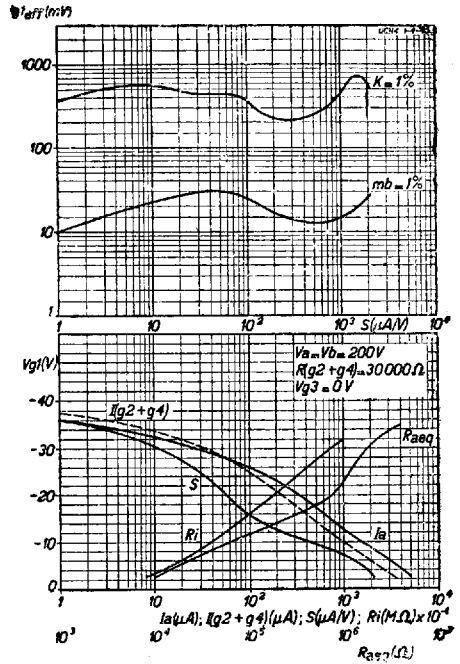

Fig. 13

Upper diagram; Maximum permissible effective value of the R.F. alternating voltage at 1% cross modulation ( $K = 1\%$ ) and also at 1% modulation hum ( $mb = 1\%$ ), both in respect of the interfering signal at the grid, as a function of grid bias, with screen grid fed through a 30,000 ohm resistance from the 200 V line. Lower diagram; Mutual conductance  $S$ , anode current  $I_a$ , screen grid current  $I(g_2 + g_4)$ , internal resistance  $R_i$  and equivalent noise resistance  $R_{aeq}$  as a function of grid bias.

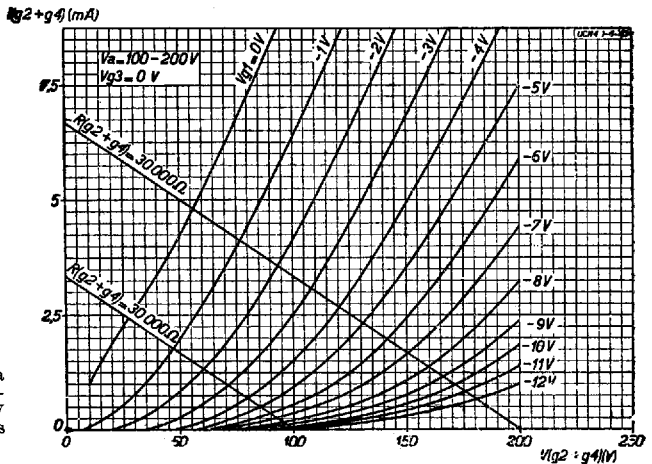

Fig. 14

Screen grid current as a function of screen grid voltage at  $V_a = 100-200V$  and  $V_{g3} = 0V$ , with  $V_{g1}$  as parameter.



**APPLICATIONS**

When the valve is employed as mixer the following points should be observed.

(I) The heptode can be connected in the usual way, the screen grids being fed through a resistance of 15,500 ohms from the source of anode voltage.

(II) In receivers which are to be operated on 220 V, 127 V or 110 V mains the most suitable bias resistance is 150 ohms, which serves both the high and the low supply voltages, as also does the screen grid resistance; none of the resistances need therefore be changed when the receiver is transferred from one mains voltage to another.

(III) On a supply voltage of 100 V and with the 150 ohm cathode resistance, the grid bias is 1 V and there is a possibility of running into grid current, but the demands to be met by a receiver are usually not so high when working on 110 V mains as on 220 V, so this tendency will be accepted as inevitable, but not very serious since the voltage produced by the automatic gain control will to a certain extent counteract this grid current.

The oscillator voltage is obtained in the normal manner, but it is advisable, in order to suppress frequency drift and "pulling" of the oscillator tuning by the R.F. circuit, to connect the tuned oscillator circuit to the anode and the reaction coupling coil to the grid of the triode in the manner shown in Fig. 17. The triode anode is fed through a 20,000 ohms resistance, the tuned circuit being coupled to that anode through a condenser of 100 to 150 pF, i.e. by parallel feed. The grid leak is 50,000 ohms and the grid condenser 50 pF, these being the best values for average conditions, whilst excluding the possibility of over-oscillation.

At a supply voltage of 100 V, parallel feed can be employed only when the reaction coupling is extremely tight, and the best practical results are obtained with an anode resistance of 20,000 ohms. As a rule, however, series-feed will be given preference

(see Fig. 18). A resistance of 28,500 ohms is then used for the triode anode and this method of feed can be maintained for 200 V supply voltage as well. It is recommended that the reaction coupling should be tighter for series than for parallel feed, especially on 100 V supply voltage and for reception on long waves.

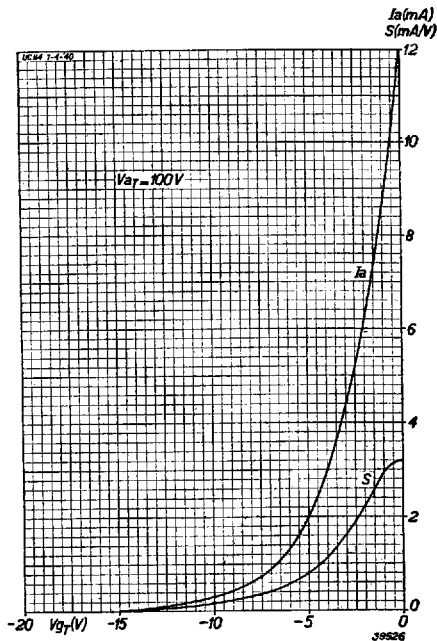

Fig. 15  
Anode current and mutual conductance of the triode part as functions of the negative grid bias at  $V_{gr} = 100$  V.

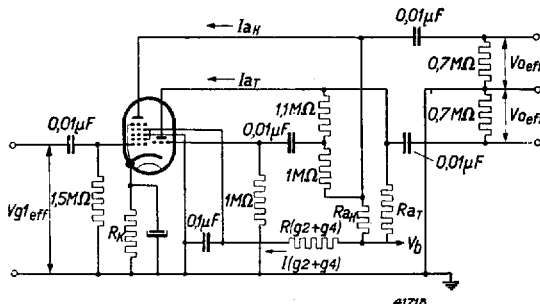

Fig. 16  
Circuit diagram showing the UCH 4 employed as phase inverter with negative feedback.

Tighter coupling can also be obtained by means of a

## UCH 4

combination of inductive and capacitive coupling through the padding condenser. Fig. 18 shows a condenser  $C_p$  employed as decoupling capacitance for the series

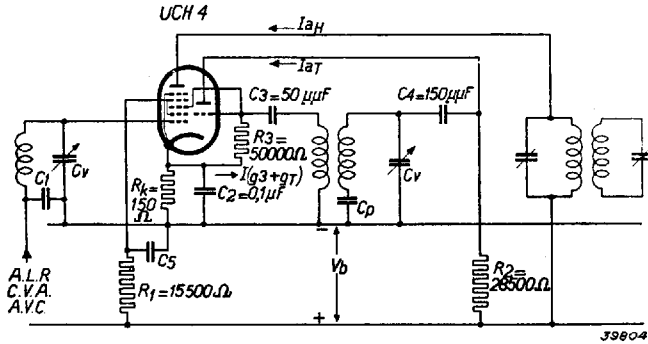

Fig. 17  
Circuit diagram for employing the UCH 4 as mixer in AC/DC sets for a working voltage of 200 V.

resistance  $R_2$ . A blocking condenser  $C_4$  of about  $0.1 \mu\text{F}$  is also included, to prevent development of a voltage at the rotor of the variable condenser, and the resistance

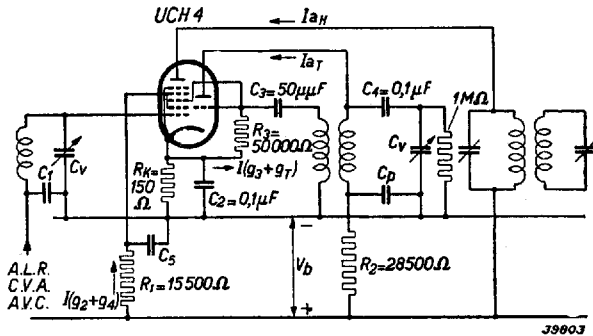

Fig. 18  
Circuit diagram showing the UCH 4 used as mixer in AC/DC receivers to work on 100 V and 200 V mains supply voltage.

of 1 megohm further prevents the tuning condenser  $C_p$  from being under a potential produced by the currents through  $C_4$ . The circuit in which the tuned oscillator circuit is coupled to the grid of the triode is undoubtedly a much simpler proposition, but in that case the frequency drift will be considerably greater.

# UF 9 R.F., I.F. and A.F. pentode

This is a variable-mu R.F. or I.F. pentode for AC or DC receivers having series-connected 100 mA heater circuits. It can also be employed as R—C coupled A.F. amplifier, with or without control (A.G.C. system including A.F. stage). The UF. 9 is designed to work on a sliding screen grid voltage, giving a lower anode current with higher mutual conductance than a valve of which the screen grid voltage is fixed and which, as far as cross-modulation is concerned in the uncontrolled condition, has the same characteristics. When the valve is used on a supply voltage of 200 V, the screen grid is fed through a resistance of 60,000 Ohms, in which case the cathode resistance is 325 Ohms and the mutual conductance in the uncontrolled condition 2.2 mA/V. On 100 V supply voltage the resistance in series with the screen grid can with advantage be short-circuited, since the grid bias in the uncontrolled state then readjusts itself to  $-2.5$  V, with the mutual conductance once more at 2.2 mA/V. If this resistance is not shorted, the resultant lower screen grid voltage, combined with the smaller anode and screen grid current, will result in a reduction of both mutual conductance and bias; the cross-modulation curve is then not so satisfactory and there is a possibility that grid current will flow when no control is applied. The very slight degree of mains hum produced by the UF9 when used as A.F. amplifier is an advantage. Very great care has been taken in the designing to reduce hum to a minimum, more especially with a view to the use of this valve in AC/DC receivers where its heater, counting from the chassis, comes second in the heater circuit and carries high alternating voltages. The UF 9 excels by reasons of its exceptionally low inter-electrode capacitances, the anode-to-grid capacitance being less than 0.002 pF. It is therefore very suitable for short-wave reception.



Fig. 1  
Dimensions in mm.

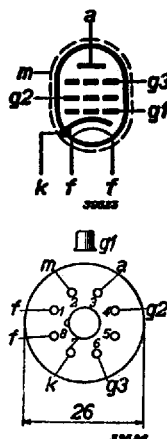

Fig. 2.  
Arrangement of electrodes and contacts.

## HEATER RATINGS

Heater feed: indirect by AC or DC; series supply.

Heater voltage . . . . .  $V_f = 12.6$  V  
 Heater current . . . . .  $I_f = 0.100$  A

## CAPACITANCES

Anode-grid . . . . .  $C_{ag1} < 0.002$  pF.  
 Grid—all other electrodes . . . . .  $C_{g1} = 4.9$  pF.  
 Anode—all other electrodes . . . . .  $C_a = 7.5$  pF.  
 Grid-filament . . . . .  $C_{g1f} < 0.005$  pF.

## OPERATING DATA: valve employed as R.F. or I.F. amplifier

a) With fixed screen grid voltage.

Anode voltage . . . . . $V_a =$	100 V	200 V
Suppressor grid voltage $V_{g3} =$	0 V	0 V
Screen grid voltage . . . $V_{g2} =$	100 V	100 V
Cathode resistance . . . $R_k =$	325 Ohms	325 Ohms
Grid bias . . . . . $V_{g1} =$	$-2.5^1)$ $-16.0^2)$ $-19.5^3)$	$-2.5^1)$ $-16.0^2)$ $-19.5^3)$ V
Anode current . . . . . $I_a =$	6	6 mA
Screen grid current . . . $I_{g2} =$	1.7	1.7 mA
Mutual conductance . . . $S =$	2200 22 7	2200 22 7 $\mu$ A/V
Internal resistance . . . $R_i =$	0.4 > 10 > 10	1.2 > 10 > 10 MOhms

<sup>1)</sup> Without control. <sup>2)</sup> Mutual cond. controlled to 1/100. <sup>3)</sup> Mutual conductance controlled to limit of range.

b) With sliding screen grid voltage.

Anode voltage . . . $V_a =$	100 V	200 V
Suppressor grid voltage . . . . . $V_{g3} =$	0 V	0 V
Screen grid resistance . . . . . $R_{g2} =$	60 000 Ohms	60,000 Ohms
Cathode resistance. $R_k =$	325 Ohms	325 Ohms
Grid bias. . . . . $V_{g1} =$	$-1.3^1)$ $-16.5^2)$ $-20^3)$	$-2.5^1)$ $-32^2)$ $-39^3)$ V
Screen grid voltage $V_{g2} =$	50 — 100	100 — 200 V
Anode current . . . $I_a =$	3.2 — —	6 — — mA
Screen grid current $I_{g2} =$	0.85 — —	1.7 — — mA
Mutual conductance $S =$	2000 20 5	2200 22 5.5 $\mu$ A/V
Internal resistance $R_i =$	1 > 10 > 10	1.2 > 10 > 10 MOhms
Gainfactor (with respect to screen grid) $\mu_{gsg1} =$	18 — —	18 — —

<sup>1)</sup> Without control. <sup>2)</sup> Valve controlled to 1/100. <sup>3)</sup> Limit of control range.

**OPERATING DATA: valve used as resistance-capacitance coupled A.F. amplifier with gain control on the control grid**

Supply voltage	Anode coupling resistance	Screen grid resistance	Anode current	Screen grid current	Cathode resistance	Control voltage on grid 1	Gain	Required alternating grid voltage and total distortion for an output voltage of:					
								$V_{o\ eff} = 3\ V$		$V_{o\ eff} = 5\ V$		$V_{o\ eff} = 8\ V$	
$V_b$ (V)	$R_a$ (M $\Omega$ )	$R_{g2}$ (M $\Omega$ )	$I_a$ (mA)	$I_{g2}$ (mA)	$R_k$ (ohms)	$-V_R$ (V)	$\frac{V_{o\ eff}}{V_{i\ eff}}$	$V_{i\ eff}$ (V)	$d_{tot}$ (%)	$V_{i\ eff}$ (V)	$d_{tot}$ (%)	$V_{i\ eff}$ (V)	$d_{tot}$ (%)
200	0.2	0.8	0.65	0.17	2500	0	88	0.034	0.75	0.057	1.2	0.091	2.0
200	0.2	0.8	0.52	0.13	2500	5	32	0.095	1.3	0.160	2.2	0.255	3.5
200	0.2	0.8	0.42	0.10	2500	10	17	0.172	1.6	0.288	2.8	0.460	4.3
200	0.2	0.8	0.33	0.07	2500	15	12	0.260	1.8	0.430	3.0	0.690	4.8
200	0.2	0.8	0.25	0.05	2500	20	8	0.382	2.2	0.640	3.7	1.020	5.9
100	0.2	0.8	0.33	0.08	2500	0	82	0.037	0.83				
100	0.2	0.8	0.25	0.06	2500	2.5	31	0.090	2.6				
100	0.2	0.8	0.20	0.04	2500	5	16	0.190	3.9				
100	0.2	0.8	0.15	0.03	2500	7.5	10	0.300	4.2				
100	0.2	0.8	0.12	0.02	2500	10	7	0.450	5.1				
200	0.1	0.4	1.22	0.35	1300	0	78	0.039	0.75	0.064	1.3	0.103	2.0
200	0.1	0.4	0.91	0.26	1300	5	29	0.100	1.3	0.170	2.2	0.275	3.5
200	0.1	0.4	0.70	0.19	1300	10	16	0.190	1.9	0.310	3.1	0.500	5.0
200	0.1	0.4	0.51	0.13	1300	15	9	0.320	2.1	0.540	3.5	0.860	5.6
200	0.1	0.4	0.36	0.09	1300	20	6	0.500	3.4	0.840	5.6	1.340	9.0
100	0.1	0.4	0.61	0.15	1300	0	72	0.042	0.83				
100	0.1	0.4	0.44	0.12	1300	2.5	29	0.104	3.8				
100	0.1	0.4	0.33	0.09	1300	5	15	0.206	3.8				
100	0.1	0.4	0.24	0.06	1300	7.5	8	0.380	5				
100	0.1	0.4	0.17	0.04	1300	10	6	0.580	6.2				

**MAXIMUM RATINGS**

Anode voltage in cold condition . . . . .	$V_{a0}$ = max. 550 V
Anode voltage . . . . .	$V_a$ = max. 250 V
Anode dissipation . . . . .	$W_a$ = max. 2 W
Screen grid voltage in cold condition . . . . .	$V_{g20}$ = max. 550 V
Screen grid voltage at $I_a = 6$ mA . . . . .	$V_{g3}$ = max. 125 V
Screen grid voltage at $I_a < 3$ mA . . . . .	$V_{g3}$ = max. 250 V
Screen grid dissipation . . . . .	$W_{g2}$ = max. 0.3 W
Cathode current . . . . .	$I_k$ = max. 10 mA
Grid current commences at ( $I_{g1} = + 0.3 \mu\text{A}$ ) . . . . .	$V_{g1}$ = max. $-1.3$ V
Max. external resistance between grid and cathode . . . . .	$R_{g1k}$ = max. $3M\Omega$
Max. external resistance between filament and cathode . . . . .	$R_{fk}$ = max. 20,000 Ohms
Max. voltage between filament and cathode (D.C. or effective value of A.C.) . . . . .	$V_{fk}$ = max. 150 V

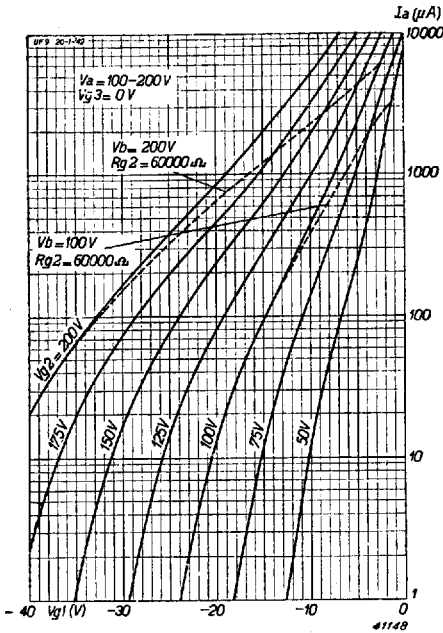

Fig. 3

Anode current as a function of grid bias at  $V_a = 100-200$  V and  $V_{g3} = 0$  V, with screen grid voltage as parameter. The broken lines show the anode current of the controlled valve, with screen grid fed through a 60,000 ohm resistance from the 200 V or 100 V supply.

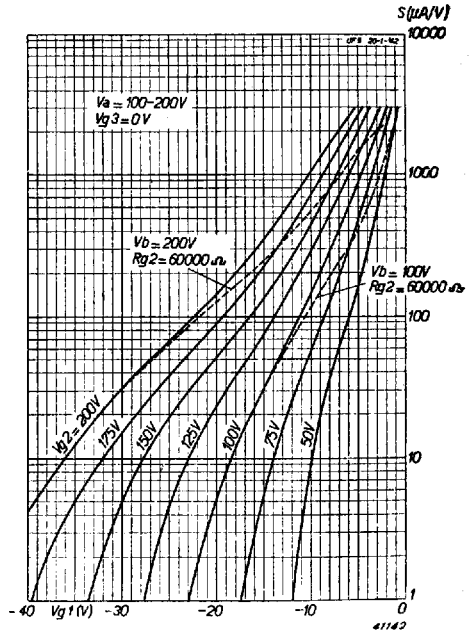

Fig. 4

Mutual conductance as a function of grid bias, with screen grid voltage as parameter. The broken lines show the course of the slope with control on the valve and the screen grid fed through a 60,000 Ohm resistance from the 200 V and 100 V supply.

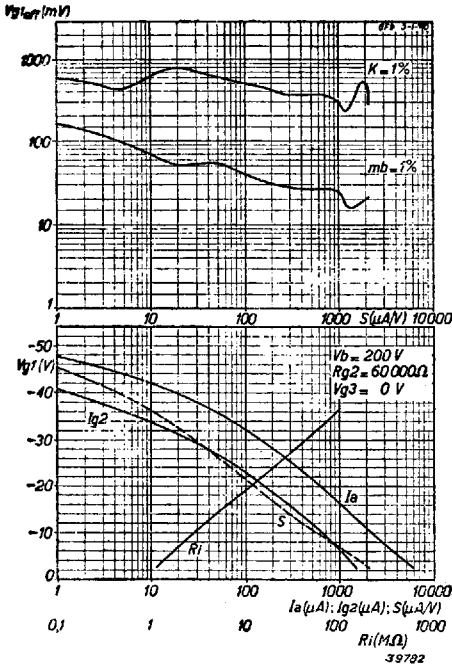

Fig. 5

At  $V_b = 200$  V,  $R_{g2} = 60,000$  Ohms (screen grid fed through a resistance) and  $V_{g3} = 0$  V: *Upper diagram*; Maximum permissible effective value of alternating grid voltage with 1% cross modulation and 1% modulation hum, as a function of mutual conductance. *Lower diagram*; Mutual conductance, anode current, screen grid current and internal resistance as a function of grid bias.

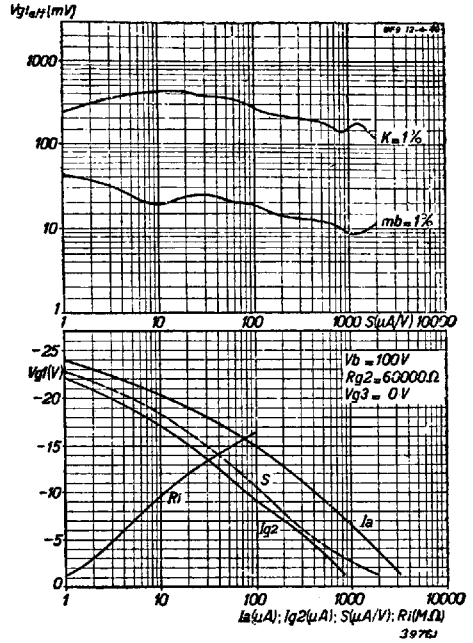

Fig. 6

At  $V_b = 100$  V,  $R_{g2} = 60,000$  ohms (resistance in series with the screen grid) and  $V_{g3} = 0$  V: *Upper diagram*; Maximum permissible effective value of alternating grid voltage with 1% cross-modulation and 1% modulation hum as a function of mutual conductance. *Lower diagram*; Mutual conductance, anode current, screen grid current and internal resistance as a function of grid bias.

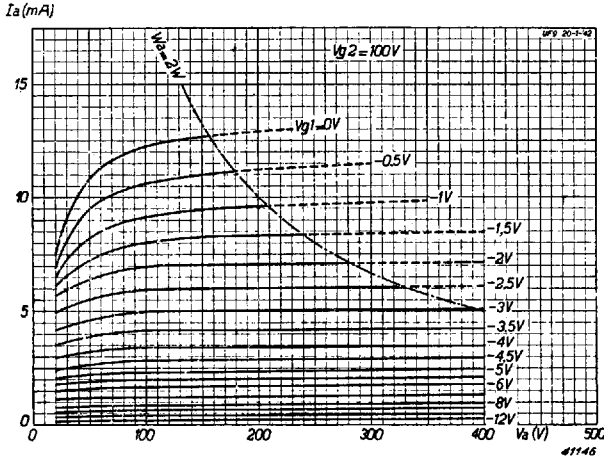

Fig. 7

Anode current as a function of anode voltage with a fixed screen grid voltage of 100 V; grid bias as parameter.

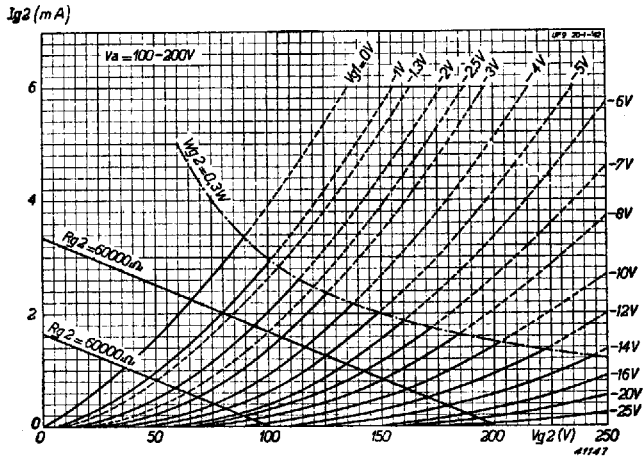

Fig. 8  
 Screen grid current as a function of screen grid voltage at  $V_a = 100-200$  V and  $V_{g1} = 0$  V, with grid bias as parameter.

# UM 4 Dual sensitivity electronic indicator

The UM 4, like the EM 4, is a dual-sensitivity tuning indicator on the screen of which two distinct fluorescent zones are formed. The distribution of light on the screen is such, however, that the variations in the dark sectors spring into view rather more than the fluorescing sectors themselves. During tuning, the variations in the widths of the two dark sectors are not uniform; in fact the sensitivity of one section is very much greater than the other, the angular variation in one being more rapid than in the other.

This effect is obtained by means of two triode sections of different amplification factors, these triodes being mounted one under the other around the cathode. A single grid serves the two units, but the pitch differs between the one system and the other. The two anodes are electrically separated; the upper and smaller one serves the low-gain triode, and the lower and larger anode the high-gain triode. Each anode is connected to a deflector-electrode, as well as to the external contacts.

The anodes of the indicator are both connected to the positive line in the receiver, in series with a 1 Megohm resistance (see also Circuit diagram IV), this potential being applied also to the fluorescent screen. Both the triodes are controlled simultaneously by the negative D.C. voltage on the grid (e.g. the control voltage from a detector diode) and actuated by a certain variation in this grid voltage, the high-gain triode producing a wider variation in the shadow angle behind the deflector electrode than the low-gain unit.

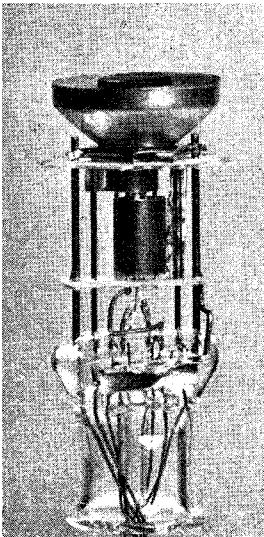

Fig. 3  
Internal construction of the UM 4.

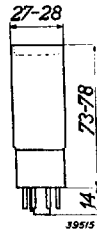
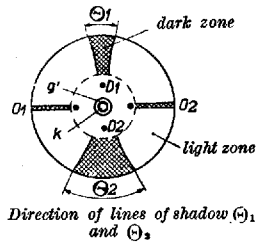
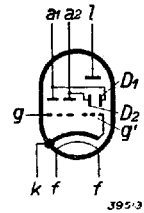

Fig. 1  
Dimensions in mm



Direction of lines of shadow ( $\Theta_1$  and  $\Theta_2$ )

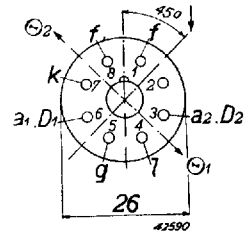

Fig. 2  
Arrangement of electrodes and contacts.

The UM 4 is so designed that the shadow angles with respect to the two deflectors will be  $90^\circ$  at zero grid voltages with supply voltages of 100 or 200 V. At a negative grid voltage of  $-4.2$  V ( $V_b = 200$  V), the shadow angle on the high-gain side is  $5^\circ$ , whereas on the other side this angle is reached only at  $-12.5$  V: an easily visible indication is thus obtained on weak as well as strong aerial signals.

Figs 4 and 5 show the characteristics of both sections of the indicator when working on supply voltages

of 200 and 100 V respectively, and these clearly illustrate the performance of the tube. The bulb of this indicator, like the EM 4, has been given a re-entrant extremity which, with the lacquered ridge of the glass, presents a dark background behind the aperture through which it is observed. This increases



the contrast between the fluorescent light and the background and facilitates observation of variations in the pattern.

**HEATER RATINGS**

Heater feed: Indirect by AC or DC; series supply.

Heater voltage. . . . .	$V_f = 12.6 \text{ V}$
Heater current. . . . .	$I_f = 0.100 \text{ A}$

**OPERATING DATA FOR THE TUBE WHEN EMPLOYED AS TUNING INDICATOR**

Voltage supply to screen and anode series resistances. . . . .

Anode coupling resistance, high-gain side

Anode coupling resistance, low-gain side

Screen current at  $V_g = 0 \text{ V}$  . . . . .

Grid voltage for a shadow angle of  $90^\circ$  in the high-gain section . . . . .

Grid voltage for a shadow angle of  $90^\circ$  in the low-gain section . . . . .

Grid voltage for a shadow angle of  $0^\circ$  in the high-gain section . . . . .

Grid voltage for a shadow angle of  $0^\circ$  in the low-gain section . . . . .

Grid voltage for a shadow angle of  $5^\circ$  in the high-gain section . . . . .

Grid voltage for a shadow angle of  $5^\circ$  in the low-gain section . . . . .

$V_s = V_b$	= 100 V	200 V
$R_{a1}$	= 1 M ohm	1 M ohm
$R_{a2}$	= 1 M ohm	1 M ohm
$I_s$	= 0.2 mA	0.55 mA
$V_g (\Theta_1 = 90^\circ)$	= 0 V	0 V
$V_g (\Theta_2 = 90^\circ)$	= 0 V	0 V
$V_g (\Theta_1 = 0^\circ)$	= -2.5 V	—
$V_g (\Theta_2 = 0^\circ)$	= -8 V	—
$V_g (\Theta_1 = 5^\circ)$	= —	-4.2 V
$V_g (\Theta_2 = 5^\circ)$	= —	-12.5 V

$\Theta_1$  = shadow angle of the deflector electrode  $D_1$ , measured at the edge of the screen.  
 $\Theta_2$  = shadow angle of the deflector electrode  $D_2$ , measured at the edge of the screen.

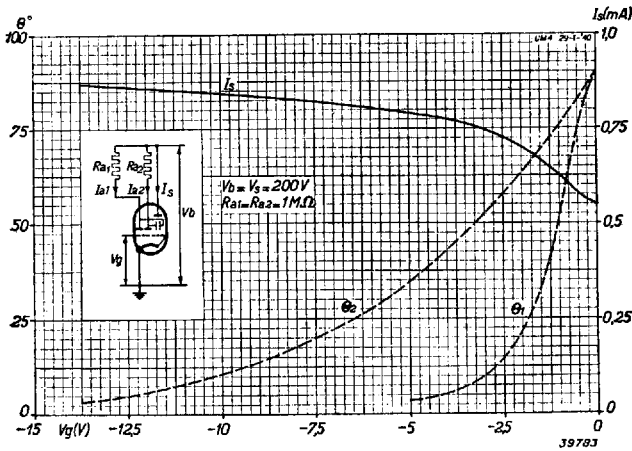

Fig. 4  
 Shadow angles  $\Theta_1$  and  $\Theta_2$ , measured at the edge of the screen, and screen current  $I_s$  as a function of grid voltage at a supply potential of 200 V.

**MAXIMUM RATINGS**

$V_{a10}$  = max. 550 V  
 $V_{a1}$  = max. 250 V  
 $V_{a20}$  = max. 550 V  
 $V_{a1}$  = max. 250 V  
 $V_{g0}$  = max. 550 V

$V_g$  = max. 250 V  
 $V_g (I_g = + 0.3 \mu A)$  = max. -1.3 V  
 $R_{gk}$  = max. 3 M Ohms  
 $R_{fk}$   $R_{gk}$  = max. 20,000 Ohms  
 $V_{fk}$  = max. 150 V<sup>1)</sup>

<sup>1)</sup> D.C. voltage or effective value of alternating voltage.

**APPLICATIONS**

The UM 4 was designed especially for use in AC/DC receivers. It is recommended that the indicator be connected to the grid leak of the detector diode, since connection to the A.G.C. diode in cases where delayed control is applied incurs the disadvantage that the indicator then gives no indication on weak signals, below the level of the delay voltage. As the more sensitive side of the indicator was expressly provided to react on weak signals, including those below the normal delay level (for short wave reception), it is, as stated, better to couple the grid of the UM 4 with the detector diode.

In many cases the signals on the detector diode will however be too strong and it will be found desirable to reduce the direct voltage on the grid leak by means of a potentiometer. Care must be taken at the same time to ensure that the A.C. resistance of the diode circuit is not reduced too much, since otherwise the ratio  $\frac{R_{d0}}{R_g}$  becomes unfavourable and the maximum modulation depth at which distortionless detection is possible is also reduced: high-resistance potentiometers should therefore be used (see also Circuit IV).

If the UM 4 is to be employed in an AC/DC receiver operating on low mains voltages, a sufficiently high voltage for the fluorescent screen must nevertheless be ensured, or the brightness of the light-pattern will fall short of requirements. At a supply voltage of 100 V it will be noticed, moreover, that the working of the high-sensitivity side of the indicator is not so effective as usual, for which reason it is better, in the case of receivers intended for use mainly on a 100 V supply, to interconnect the two anodes of the triodes and feed these through a common resistance of 1 M Ohm. Figs 6 and 7 show the characteristic curves thus obtained in respect of  $V_b = 100$  V and 200 V. The variations in the shadow angle can then be clearly observed, even at lower values of the control voltage on the grid.

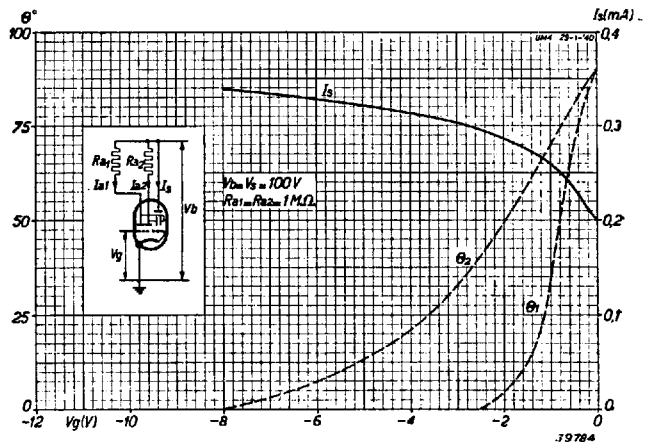

Fig. 5  
 Shadow angles  $\theta_1$  and  $\theta_2$ , measured at the edge of the screen, and screen current  $I_s$  as a function of grid voltage on a supply voltage of 100 V.

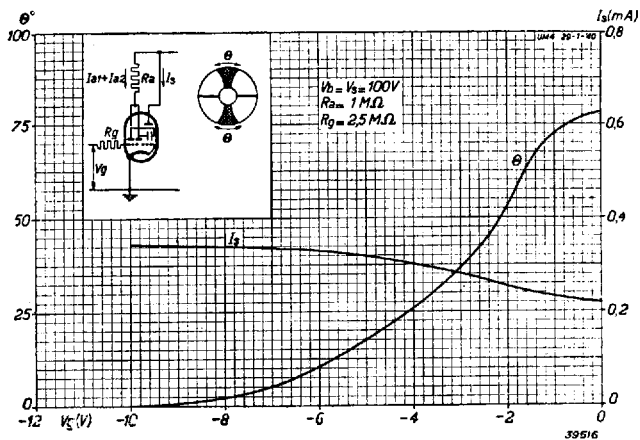

Fig. 6

Shadow angle ( $\ominus$ ) of the two sectors, and screen current  $I_s$  as a function of grid voltage, with the two anodes of the triodes fed in parallel through a 1 M Ohm resistance, on a supply of 100 V.

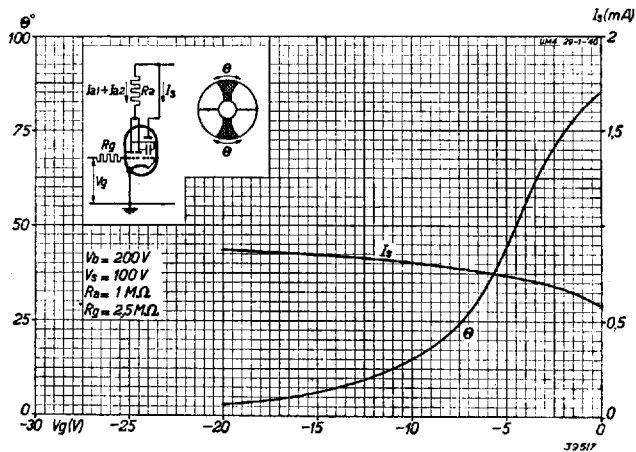

Fig. 7

Shadow angle ( $\ominus$ ) of the two sectors, and screen current  $I_s$  as a function of grid voltage, with the two anodes of the triodes fed in parallel through a 1 M Ohm resistance, on a supply of 200 V.

# UY 1 (N) Half-wave rectifier valve

The UY 1 (N) is an indirectly heated half-wave rectifier for use in AC/DC receivers with 100 mA series heater circuit. The internal resistance of this valve is very low and voltage losses are therefore only slight, this being a very great advantage when the receiver is to operate on 100 V mains. This rectifier is a new version of the UY 1 and differs from the UY 21 only in the base.

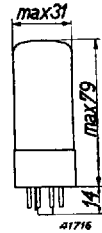

Fig. 1  
Dimensions in mm

## HEATER RATINGS

Heater feed: indirect by AC or DC; series supply.

Heater voltage . . . . .  $V_f = 50$  V

Heater current . . . . .  $I_f = 0.100$  A

## MAXIMUM RATINGS

- Alternating anode voltage . . . . .  $V_i = \text{max. } 250$  V<sub>eff</sub>
- D.C. output . . . . .  $I_o = \text{max. } 140$  mA
- Voltage between filament and cathode . . .  $V_{fk} = \text{max. } 500$  V (peak)
- Capacitance across input of smoothing filter . . . . .  $C = \text{max. } 60$   $\mu\text{F}^1$



<sup>1)</sup> A resistance of which the minimum value is given in the following table must be included in the anode circuit to safeguard the valve.

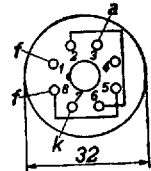

Fig. 2  
Arrangement of electrodes and contacts.

Mains voltage	Capacitance of smoothing condenser	Resistance to safeguard the valve
max. 250 V	60 $\mu\text{F}$	min. 175 Ohms
max. 250 V	32 $\mu\text{F}$	min. 125 Ohms
max. 250 V	16 $\mu\text{F}$	min. 75 Ohms
max. 250 V	8 $\mu\text{F}$	min. 0 Ohms
max. 170 V	60 $\mu\text{F}$	min. 100 Ohms
max. 170 V	32 $\mu\text{F}$	min. 75 Ohms
max. 170 V	16 $\mu\text{F}$	min. 30 Ohms
max. 127 V	60 $\mu\text{F}$	0 Ohms

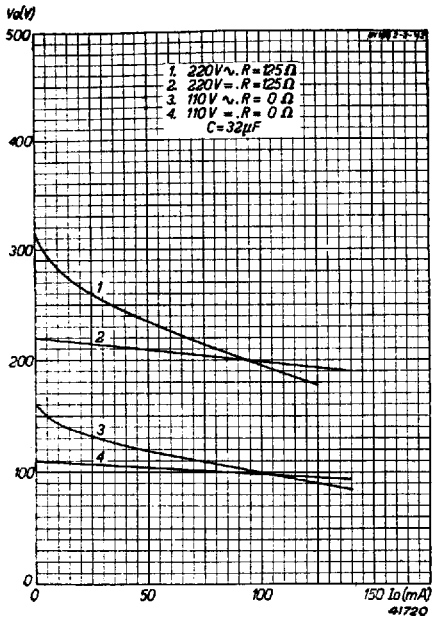

Fig. 3  
Load lines for the rectifier UY 1 (N).

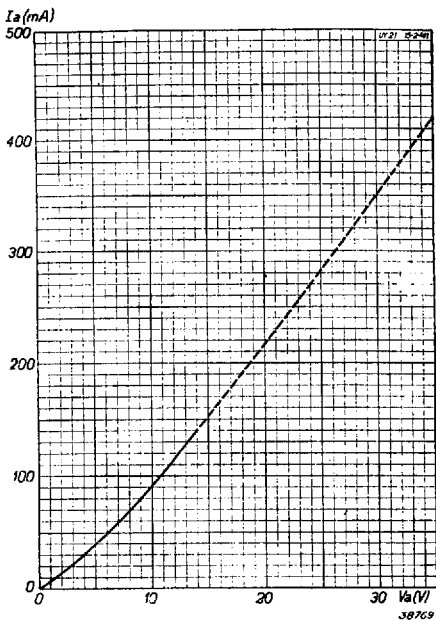

Fig. 4  
Current as a function of applied direct voltage.

## IX. 4-Valve superheterodyne receiver for 220 V AC/DC Mains

*Valves used:* UCH 4, UF 9, UF 9, UBL 1, UM 4, UY 1 (N).

*Wave ranges:*

Long waves	830—2090 m
Medium waves	195—570 m
Short waves	17—51 m

### *R.F., I.F. and oscillator circuits*

These are exactly the same as in Circuit I; for details of the coils see p. 62. The screen grids of the mixer and I.F. valves are fed by means of resistances to obtain a sliding screen grid voltage and the characteristics from the point of view of cross-modulation are therefore good.

The suppressor grid is employed as third diode in a 3-diode circuit. Grid bias is obtained from the voltage drop across resistances  $R_6$  and  $R_7$ , this being tapped from a potentiometer comprising resistances  $R_8$ ,  $R_9$ ,  $R_{17}$  and  $R_{18}$ . The gain factor is 120.

### *Diodes for detection and automatic gain control*

The UBL 1 has two diodes, of which  $d_1$  is used in the usual manner for detection and  $d_2$  for the automatic gain control, the latter being connected to the primary side of the final I.F. transformer. No delay voltage is applied to this diode, in order that distortion may be avoided; the A.G.C. is delayed by means of the suppressor grid of the I.F. valve UF 9. As long as this grid is at a positive potential (across  $R_{19}$ ), grid current flows and no control is applied to the R.F. and I.F. valves, but immediately the anode  $d_2$  becomes sufficiently negative to check the grid current the A.G.C. comes into operation. Diode  $d_1$  is connected to a tapping on the I.F. coil to reduce the damping effect of this diode on the I.F. circuit.

### *A.F. amplifier*

The A.F. voltage is taken from the volume control  $R_{12}$ , by way of a condenser  $C_{39}$ , to the grid of the A.F. valve UF 9. To prevent the possibility of hum, arising from D.C. mains which include considerable ripple, the anode voltage is smoothed by means of a filter  $R_{37}-C_{37}$ .

### *Tone control*

Tone control is obtained by means of the potentiometer  $R_{11}$ , in series with condenser  $C_{31}$ .

### *Gramophone pickup connection*

The output from a gramophone pickup is applied through condensers  $C_{42}$  and  $C_{43}$  to the volume control  $R_{12}$ . A resistance  $R_{10}$  is connected in series with the volume control, as otherwise diode  $d_1$  would be in parallel with the pickup.

### *Output stage*

The output valve is a high slope 11 W double-diode pentode, UBL 1. Low value resistances are included in the control and screen grid circuits to suppress parasitic oscillation.

As the use of a bias resistance on the cathode would result in a delay voltage on both diodes, the cathode is earthed (chassis). Grid bias is obtained from  $R_6$  and  $R_7$  and is applied to the control grid across  $R_{20}$ . Since these resistances are in the negative line and all the currents in the receiver pass through them, efficient smoothing ( $C_{19}$  and  $C_{20}$ ) is essential.

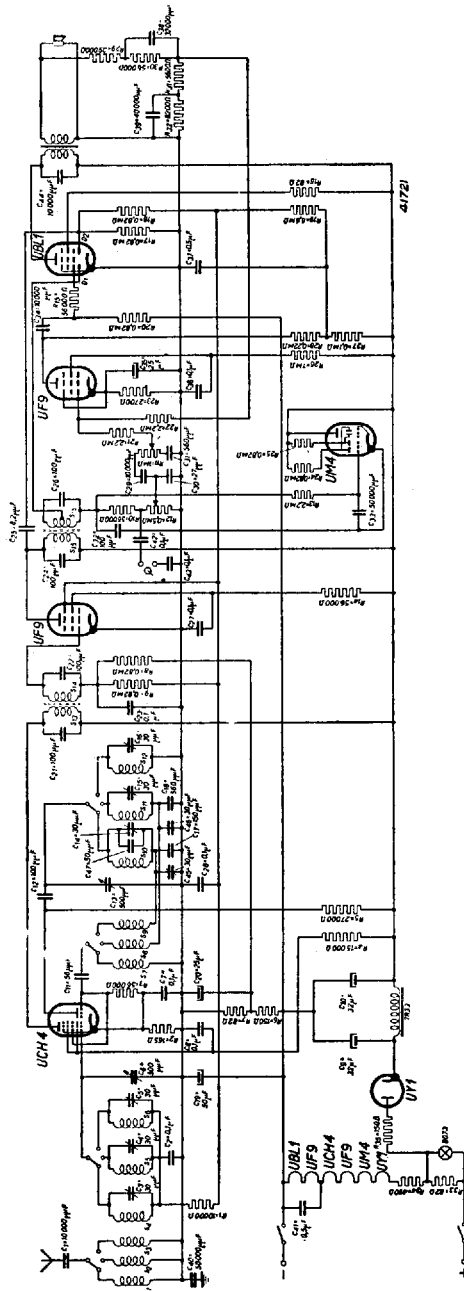

Circuit diagram of 4-valve superheterodyne receiver for 230 V AC/DC mains operation.  
(Published without any guarantees in respect of patent rights.)

### *Negative feedback*

A portion of the voltage on the voice coil is returned across the potentiometers  $R_{29}$ ,  $R_{30}$ ,  $R_{31}$  and  $R_{32}$ , together with resistance  $R_{23}$ , to the control grid of the UF 9.  $R_{30}$  and  $R_{32}$  are shunted by condensers the value of which is such that the feedback is attenuated on the higher and lower tones, thus giving uniform reproduction throughout the whole of the A.F. range. A resistance  $R_{21}$  is also included on the other side of the grid of the UF 9, to check the tendency of the tone control to smooth out the feedback voltage too much; the resultant loss in the A.F. gain is 50 %.

### *Tuning indicator*

"Magic eye" tuning indication is provided by the UM 4, the dual-sensitivity electronic indicator, which enables weak signals to be tuned in with just as much ease as the stronger ones. The negative detector-diode voltage is applied through a filter circuit  $R_{13}-C_{33}$  to the grid of the UM 4. If the latter is connected to the A.G.C. diode it will not register weak signals, because of the delay voltage. The filter  $R_{13}-C_{33}$  checks the passage of any A.F. voltages to the grid of the indicator.  $R_{13}$  must be of a high value to ensure that there will not be too much reduction in the A.C. resistance of the diode.

### *Heater and pilot lamp circuits*

The heaters of the valve are all connected in series, together with a resistance  $R_{34}$  and the pilot lamp, type 8073 (6 V, 0.1 A), with a further resistance  $R_{33}$  in parallel with the latter. The initial current surge when the set is switched on has to be taken into account, and resistance  $R_{33}$  absorbs part of it, thus preventing the pilot lamp from burning out: as soon as the normal heater current starts flowing through the valves it will pass through the pilot lamp, as well as through  $R_{33}$  and, to ensure that the former receives sufficient current, the anode of the rectifier is connected between  $R_{34}$  and  $R_{33}$ , to allow extra current to pass to the pilot lamp when the valves have warmed up. The value of  $R_{33}$  should be so selected that the lamp is not overloaded on A.C. and slightly under voltage when on D.C. mains, taking as basis the effective value of the rectified current, which on A.C. is about twice as much as on D.C. feed. The sequence of the valve heaters is arranged to give the least possible amount of hum, this being the reason for connecting the UBL 1 at the chassis end (earth). Condenser  $C_{41}$  smooths out the heater voltage for the A.F. valves UF 9 and UBL 1 and prevents the passage of any high-frequency hum.

### *Anode feed*

The rectifier is a UY 1 (N). As one side of the mains voltage is applied direct to the chassis, condensers are included in the aerial, earth and gramophone pickup circuits; the chassis itself, therefore, must not be earthed. Two electrolytic condensers of 32  $\mu$ F each, with an 8-henry choke, take care of the smoothing. The total output of current is about 60 mA.

## ELECTRICAL DATA

*Sensitivity* (for an output of 50 mW, with neg. feedback).

At the diode	0.6 V	} I.F. gain factor: 120. } Conversion gain factor: 163. } Voltage gain factor: 3.
At the I.F. valve	5 mV	
At the mixer valve	30 $\mu$ V	
At the aerial	10 $\mu$ V	



*Selectivity*

Attenuation due to detuning + 4 and — 4 kc/s: 1 : 10.

Attenuation due to detuning + 7 and — 7 kc/s: 1 : 100.

Attenuation due to detuning +12 and —12 kc/s: 1 : 1000.

*A.G.C. characteristic*

1 × normal input voltage				corresponds to	1 × normal output voltage			
5 ×	''	''	''	''	5 ×	''	''	''
10 ×	''	''	''	''	8 ×	''	''	''
100 ×	''	''	''	''	20 ×	''	''	''
1000 ×	''	''	''	''	22 ×	''	''	''
10000 ×	''	''	''	''	24 ×	''	''	''



**Two valves for A.C. operation  
ECH 4 and EL 50**

# ECH 4 Triode-heptode

The ECH 4 is a triode-heptode of which the electrical characteristics are similar to those of the "all-glass" valve ECH 21. The triode and heptode units both have their own separate external connections and can therefore be used for individual purposes.

For details of the various applications of this valve reference may be made to the particulars of the ECH 21 on p. 15. The electrical data are summarised below for easy reference and the characteristics are the same as those of the ECH 21.

## HEATER RATINGS

Heater feed: indirect, by A.C.; parallel feed.

Heater voltage. . . . .	$V_f = 6.3$ V
Heater current. . . . .	$I_f = 0.35$ A

## CAPACITANCES

a) heptode section:

$C_{g1}$	= 5.6 pF	$C_{g1g3}$	< 0.2 pF
$C_a$	= 9.2 pF	$C_{g3\uparrow}$	= 8.9 pF
$C_{ag1}$	< 0.002 pF	$C_{g1f}$	< 0.001 pF

b) triode section:

$C_g$	= 6.0 pF	$C_{ak}$	= 2.5 pF
$C_a$	= 5.4 pF	$C_{ag}$	= 2.1 pF
$C_{gt}$	= 3.0 pF	$C_{gf}$	< 0.3 pF

c) between heptode and triode and both combined:

$C_{gTg1H}$	< 0.1 pF	$C_{(gT+gs)g1H}$	< 0.25 pF
$C_{(gT+gs)}$	= 14 pF	$C_{(gT+gs)aH}$	< 0.1 pF

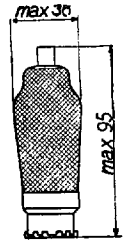

Fig. 1  
Dimensions in mm.

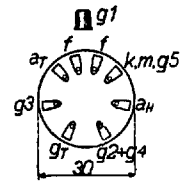
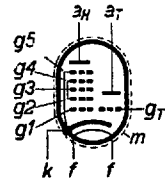

Fig. 2  
Arrangement of electrodes and contacts.

## OPERATING DATA: HEPTODE SECTION EMPLOYED AS MIXER VALVE (3rd grid connected to triode grid)

Anode and supply voltage. . . . .	$V_a = V_b =$	250 V
Screen grid resistance . . . . .	$R_{(g2+g4)} =$	24,000 Ohms
Cathode resistance . . . . .	$R_k =$	150 Ohms
Grid leak: 3rd grid and triode grid . . . .	$R_{(g3+gT)} =$	50,000 Ohms
Current to 3rd grid and triode grid . . . .	$I_{(g3+gT)} =$	190 $\mu$ A
Grid bias . . . . .	$V_{g1} = -2^1)$	-24.5 <sup>2)</sup> V
Screen grid voltage. . . . .	$V_{(g2+g4)} =$	100 250 V
Anode current . . . . .	$I_a =$	3 mA
Screen grid current. . . . .	$I_{(g2+g4)} =$	6.2 mA
Internal resistance . . . . .	$R_i =$	1.4 > 3 M ohms
Conversion conductance. . . . .	$S_c =$	750 7.5 $\mu$ A/V
Equivalent noise resistance . . . . .	$R_{eq} =$	55,000 Ohms.

<sup>1)</sup> Valve not controlled.  
<sup>2)</sup> Mutual conductance controlled to 1/100.

**OPERATING DATA: HEPTODE SECTION EMPLOYED AS I.F. AMPLIFIER**  
 (3rd grid not connected to triode grid)

Anode and supply voltage . . . . .	$V_a = V_b =$	250 V	
Voltage on 3rd grid . . . . .	$V_{g3} =$	0 V	
Screen grid resistance . . . . .	$R_{(g2+g4)} =$	45,000 Ohms	
Grid bias . . . . .	$V_{g1} =$	-21 <sup>1)</sup> -36 <sup>2)</sup> -44 <sup>3)</sup> V	
Screen grid voltage . . . . .	$V_{(g2+g4)} =$	90 — 250 V	
Anode current . . . . .	$I_a =$	5.3 — — mA	
Screen grid current . . . . .	$I_{(g2+g4)} =$	3.5 — — mA	
Mutual conductance . . . . .	$S =$	2200 22 2.2 $\mu$ A/V	
Internal resistance . . . . .	$R_i =$	0.9 >10 >10 M Ohms	
Gain factor, in respect of screen-control grid . . . . .	$\mu_{g2g1} =$	18 — —	
Equivalent noise resistance . . . . .	$R_{eq} =$	7500 — — Ohms	

- 1) Valve not controlled.
- 2) Mutual conductance controlled to 1/100.
- 3) Mutual conductance controlled to 1/1000 (limit of control).

**STATIC RATINGS FOR THE TRIODE SECTION**

Anode voltage . . . . .	$V_a =$	100 V
Grid bias . . . . .	$V_g =$	0 V
Anode current . . . . .	$I_a =$	12 mA
Mutual conductance . . . . .	$S =$	3.2 mA/V
Gain factor . . . . .	$\mu =$	22

**OPERATING DATA: TRIODE SECTION EMPLOYED AS OSCILLATOR VALVE** (triode grid connected to third grid of heptode)

Supply voltage . . . . .	$V_b =$	250 V
Anode resistance . . . . .	$R_a =$	20,000 Ohms
Grid leak . . . . .	$R_{(gT+g3)} =$	50,000 Ohms
Current through grid leak to be adjusted to . . . . .	$I_{(gT+g3)} =$	190 $\mu$ A
Anode current . . . . .	$I_a =$	4.5 mA

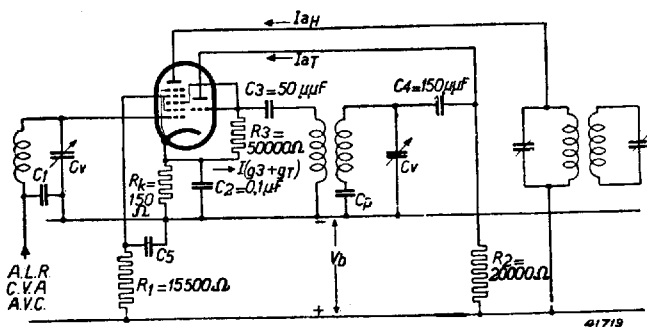

Fig. 3  
 Circuit diagram showing the ECH 4 employed as mixer valve.

**OPERATING DATA: TRIODE SECTION EMPLOYED AS A.F. AMPLIFIER VALVE, Resistance-Capacitance coupled (triode grid not connected to third grid of heptode)**

Supply voltage . . .	$V_b$	=	250	250	250 V
Anode resistance. . .	$R_a$	=	0.2	0.1	0.05 M Ohms
Grid bias. . . . .	$V_g$	=	-2	-4	-2 -4 V
Anode current . . .	$I_a$	=	1	0.9	2 1.7 3.5 3 mA
Alternating output voltage. . . . .	$V_{o\ eff}$	=	7.5	7.5	7.5 7.5 V
Total distortion . . .	$d_{tot}$	=	2.5	2.0	2.1 1.6 2.1 1.5 %
Voltage gain . . . . .	$\frac{V_{o\ eff}}{V_{g1\ eff}}$	=	13	12	14 13 14 13

**OPERATING DATA FOR THE ECH 4 EMPLOYED AS PHASE INVERTER for the modulation of a push-pull output stage**

(with negative feed-back; see fig. 4. Triode grid not connected to third grid of heptode)

Supply voltage . . . . .	$V_b$	=	250 V
Anode resistance, heptode..	$R_{aH}$	=	0.2 M Ohms
Anode resistance, triode. .	$R_{aT}$	=	0.1 M Ohms
Screen grid resistance . . .	$R_{(g2+g4)}$	=	0.25 M Ohms
Cathode resistance . . . . .	$R_k$	=	650 Ohms
Neg. control voltage on grid of heptode . . . . .	$V_R$	=	0 -5 -10 -15 -20 V
Combined anode current: heptode and triode . . .	$I_{aH} + I_{aT}$	=	2.5 2.45 2.35 2.25 2.15 mA
Screen grid current . . . .	$I_{(g2+g4)}$	=	0.75 0.58 0.43 0.32 0.24 mA
Alternating input voltage .	$V_{g1\ eff}$	=	0.10 0.33 0.66 1.0 1.6 V
Voltage gain . . . . .	$\frac{V_{o\ eff}}{V_{g1\ eff}}$	=	100 30 15 10 6
Alternating output voltage.	$V_{o\ eff}$	=	10 10 10 10 10 V
Total distortion . . . . .	$d_{tot}$	=	0.80 3.70 4.50 6.20 7.50 %

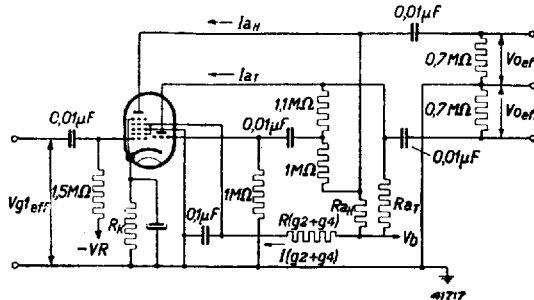

Fig. 4  
Circuit diagram showing the ECH 4 employed as phase inverter with negative feed-back, to illustrate the above description and symbols.

## MAXIMUM RATINGS FOR THE HEPTODE SECTION

Anode voltage in cold condition . . . . .	$V_{ao}$	= max. 550 V
Anode voltage . . . . .	$V_a$	= max. 300 V
Anode dissipation . . . . .	$W_a$	= max. 1.5 W
Screen grid voltage in cold condition . . . . .	$V_{(g_2+g_4)o}$	= max. 550 V
Screen grid voltage, valve uncontrolled ( $I_a=3\text{ mA}$ )	$V_{(g_2+g_4)}$	= max. 100 V
Screen grid voltage, valve controlled ( $I_a<1\text{ mA}$ )	$V_{(g_2+g_4)}$	= max. 300 V
Screen grid dissipation . . . . .	$W_{(g_2+g_4)}$	= max. 1 W
Cathode current . . . . .	$I_k$	= max. 15 mA
Grid current commences at ( $I_{g_1} = + 0.3\ \mu\text{A}$ )	$V_{g_1}$	= max. $-1.3\text{ V}$
Grid current commences at ( $I_{g_3} = + 0.3\ \mu\text{A}$ )	$V_{g_3}$	= max. $-1.3\text{ V}$
Max. external resistance between grid 1 and cathode . . . . .	$R_{g_1k}$	= max. 3 M Ohms
Max. external resistance between filament and cathode . . . . .	$R_{fk}$	= max. 20,000 Ohms
Max. external resistance between grid 3 and cathode . . . . .	$R_{g_3k}$	= max. 3 M Ohms
Max. voltage between filament and cathode (D.C. voltage or effective value of alternating voltage) . . . . .	$V_{fk}$	= max. 50 V

## MAXIMUM RATINGS FOR THE TRIODE SECTION

Anode voltage in cold condition . . . . .	$V_{ao}$	= max. 550 V
Anode voltage . . . . .	$V_a$	= max. 100 V
Anode dissipation . . . . .	$W_a$	= max. 0.5 W
Grid current commences at ( $I_g = + 0.3\ \mu\text{A}$ ) . . . . .	$V_g$	= max. $-1.3\text{ V}$
Max. external resistance in grid circuit . . . . .	$R_{gk}$	= max. 3 M Ohms

# EL 50 Amplifier for push-pull output stages

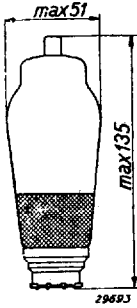

Fig. 1  
Dimensions in mm.

The EL 50 is a pentode with a maximum anode dissipation of 18 W, having been designed especially for balanced output stages. Two of these valves in Class A/B at a maximum anode voltage of 800 V will provide an output of 84 W and this high anode voltage can be employed without the necessity for any special precautions in view of the fact that the anode connection is situated at the top of the bulb.

The form of the dynamic characteristic, moreover, is such as to render the valve relatively insensitive to electrical discrepancies between the two valves used in the stage. Like the 4654, the EL 50 can also be employed on a supply voltage of 425 V ( $V_a = 400$  V,  $V_{g2} = 425$  V), in which case the maximum output power of the two valves, on a fixed grid bias, is 50 W.

The ratings and operating data for this valve are given below.

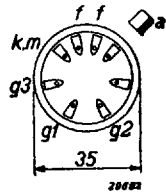
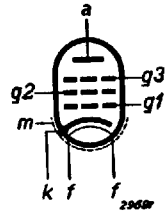
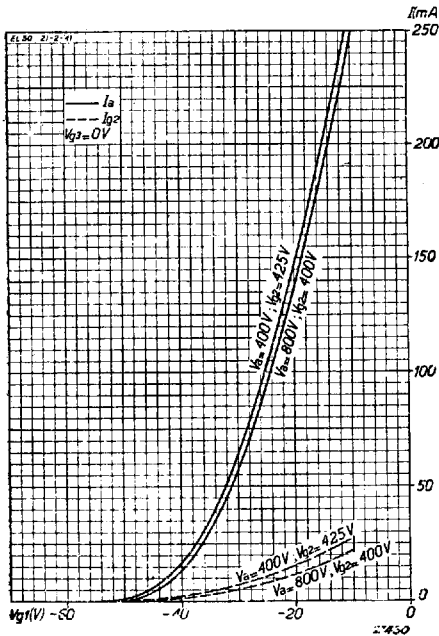

Fig. 2  
Arrangement of electrodes and contacts.



## HEATER RATINGS

Heater feed: indirect, A.C. parallel feed.  
 Heater voltage . . . .  $V_f = 6.3$  V  
 Heater current . . . .  $I_f = 1.35$  A

## CAPACITANCES

Anode-control grid capacitance  
 $C_{ag1} < 0.8$  pF

Fig. 3  
Anode and screen voltage as a function of grid bias at  $V_a = 400$  V,  $V_{g2} = 425$  V and  $V_a = 800$  V,  $V_{g2} = 400$  V.



**STATIC RATINGS**

Anode voltage . . . . .	$V_a = 400 \text{ V}$	800 V
Screen grid voltage . . . . .	$V_{g2} = 425 \text{ V}$	400 V
Suppressor grid voltage . . . . .	$V_{g3} = 0 \text{ V}$	0 V
Anode current . . . . .	$I_a = 45 \text{ mA}$	22.5 mA
Screen grid current . . . . .	$I_{g2} = 5.5 \text{ mA}$	2.5 mA
Grid bias . . . . .	$V_{g1} = -33 \text{ V}$	-37 V
Mutual conductance . . . . .	$S = 6 \text{ mA/V}$	4 mA/V
Internal resistance . . . . .	$R_i = 30,000 \text{ Ohms}$	50,000 Ohms

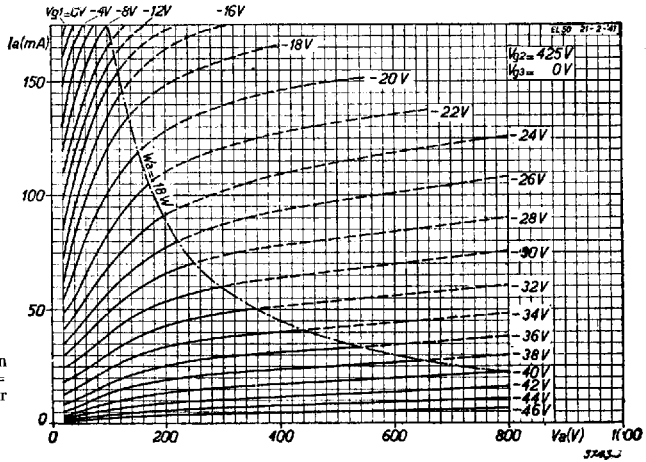

Fig. 4  
Anode current as a function of anode voltage at  $V_{g2} = 425 \text{ V}$ , with  $V_{g1}$  as parameter (400 V operation).

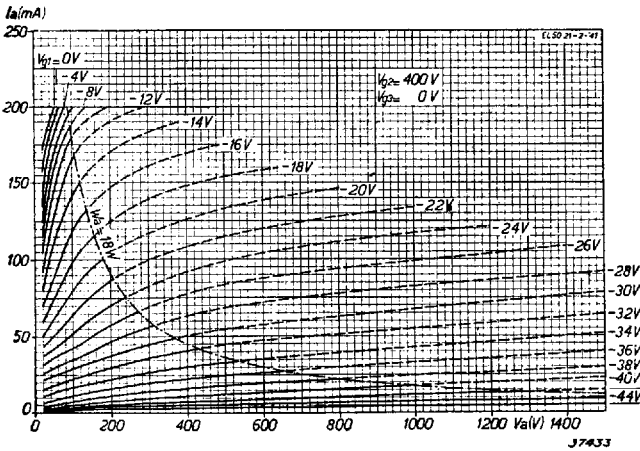

Fig. 5  
Anode current as a function of anode voltage at  $V_{g2} = 400 \text{ V}$ , with  $V_{g1}$  as parameter (800 V operation).

**DYNAMIC DATA for two EL 50 valves in class AB adjustment with automatic negative grid bias**

Anode voltage . . . . .	$V_a$	= 400 V
Screen grid voltage . . . . .	$V_{g2}$	= 425 V
Intercepting grid voltage . . . . .	$V_{g3}$	= 0 V
Cathode resistance . . . . .	$R_k$	= 315 Ohms
Anode rest current . . . . .	$I_{a0} (V_{g1\text{eff}} = 0)$	= $2 \times 45$ mA
Anode current at max. modulation . . . . .	$I_a (W_o = \text{max})$	= $2 \times 52.5$ mA
Screen grid rest current . . . . .	$I_{g20} (V_{g1\text{eff}} = 0)$	= $2 \times 5.5$ mA
Screen grid current at max. modulation . . . . .	$I_{g2} (W_o = \text{max})$	= $2 \times 19$ mA
Optimum matching resistance between the two anodes . . . . .	$R_{aa'}$	= 9000 Ohms
Max. output . . . . .	$W_o \text{ max}$	= 30 W
Total distortion . . . . .	$d_{\text{tot}}$	= 10 %
Grid a.c. voltage required . . . . .	$V_{g1\text{eff}}$	= 25 V

**DYNAMIC DATA for two EL 50 valves in class AB adjustment with fixed negative grid bias**

Anode voltage . . . . .	$V_a$	= 400 V	800 V
Screen grid voltage . . . . .	$V_{g2}$	= 425 V	400 V
Intercepting grid voltage . . . . .	$V_{g3}$	= 0 V	0 V
Negative grid bias . . . . .	$V_{g1}$	= -35 V	-37.5 V
Anode rest current . . . . .	$I_{a0} (V_{g1\text{eff}} = 0)$	= $2 \times 25$ mA	$2 \times 15$ mA
Anode current at max. modulation . . . . .	$I_a (W_o = \text{max})$	= $2 \times 95$ mA	$2 \times 70$ mA
Screen grid rest current . . . . .	$I_{g20} (V_{g1\text{eff}} = 0)$	= $2 \times 2.5$ mA	$2 \times 1.25$ mA
Screen grid current at max. modulation . . . . .	$I_{g2} (W_o = \text{max})$	= $2 \times 22$ mA	$2 \times 20$ mA
Optimum matching resistance between the two anodes . . . . .	$R_{a'a'}$	= 5000 Ohms	16,000 Ohms
Max. output . . . . .	$W_o \text{ max}$	= 50 W	84 W
Total distortion . . . . .	$d_{\text{tot}}$	= 3.4 %	6.6 %
Grid a.c. voltage required . . . . .	$V_{g1\text{eff}}$	= 25 V	23 V

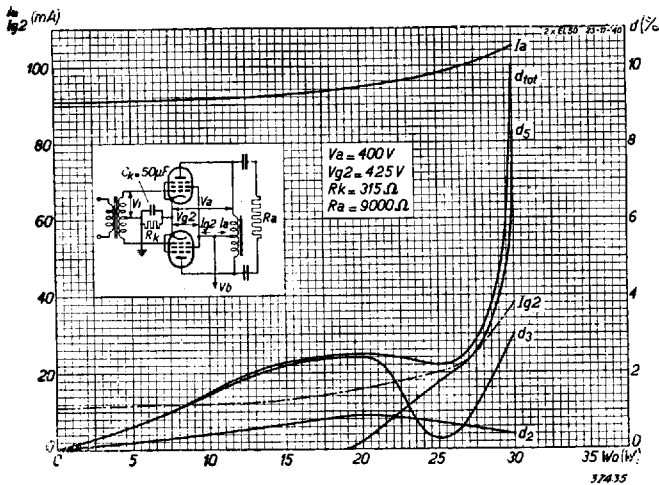

Fig. 6  
Anode current  $I_a$ , screen grid current  $I_{g2}$ , and distortion  $d$  as a function of output power  $W_o$  of two EL 50 valves in push-pull circuit, with automatic grid bias at  $V_a = 400$  V,  $V_{g2} = 425$  V and  $R_{aa'} = 9000$  ohms.

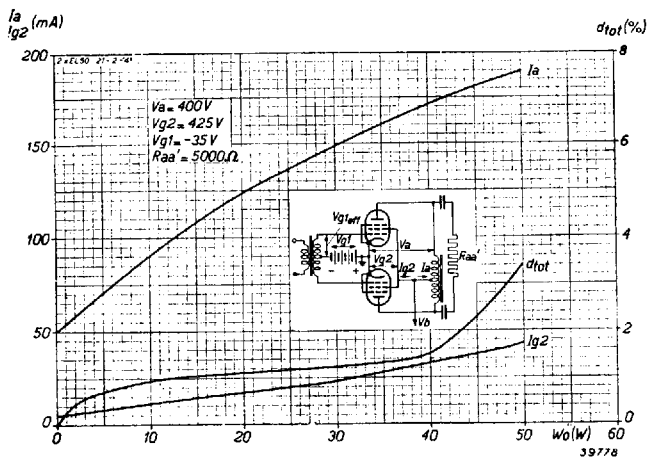

Fig. 7  
Anode current  $I_a$ , screen grid current  $I_{g2}$  and distortion  $d$  as function of output power  $W_o$  of two EL 50 valves in push-pull circuit with fixed grid bias, at  $V_a = 400$  V,  $V_{g2} = 425$  V,  $V_{g1} = -35$  V and  $R_{aa}' = 5000$  Ohms.

Fig. 8  
Maximum output  $W_o$  as a function of load resistance  $R_{aa}'$  of two EL 50 valves in push-pull circuit with fixed grid bias, at  $V_a = 400$  V,  $V_{g2} = 425$  V and  $V_{g1} = -35$  V. The broken line  $W_{o\max} (+ I_{g1})$  represents the limit to which the valves can be modulated without grid current flowing; in this case, however, the maximum anode dissipation is exceeded.

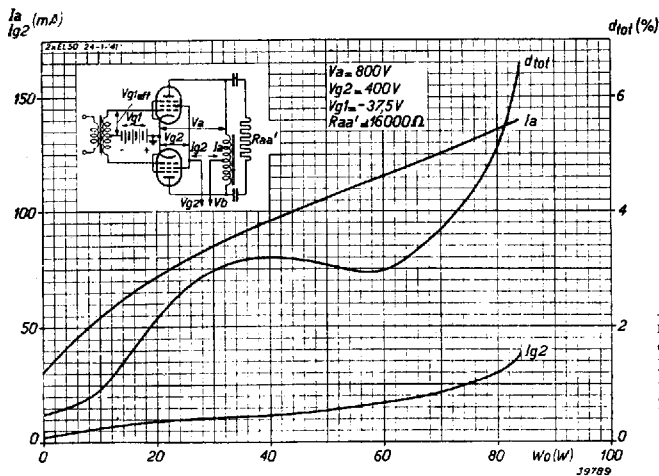
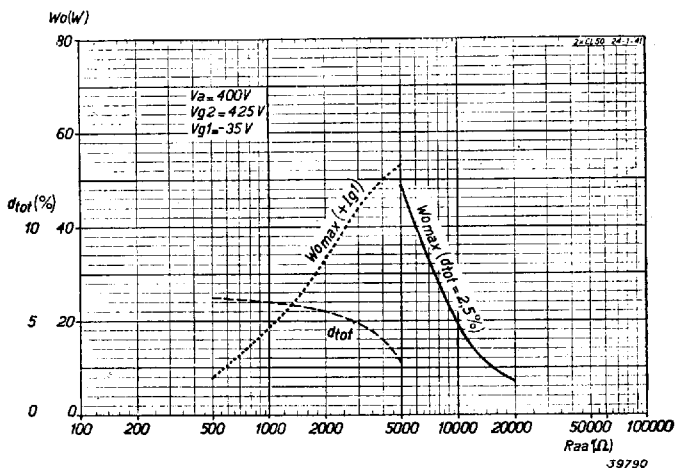

Fig. 9  
Anode current  $I_a$ , screen current  $I_{g2}$  and total distortion  $d_{tot}$  as function of the output power  $W_o$  of two push-pull EL 50 valves, with fixed grid bias, at  $V_a = 800$  V,  $V_{g2} = 400$  V and  $V_{g1} = -37.5$  V;  $R_{aa}' = 16,000$  Ohms.

**EL 50**

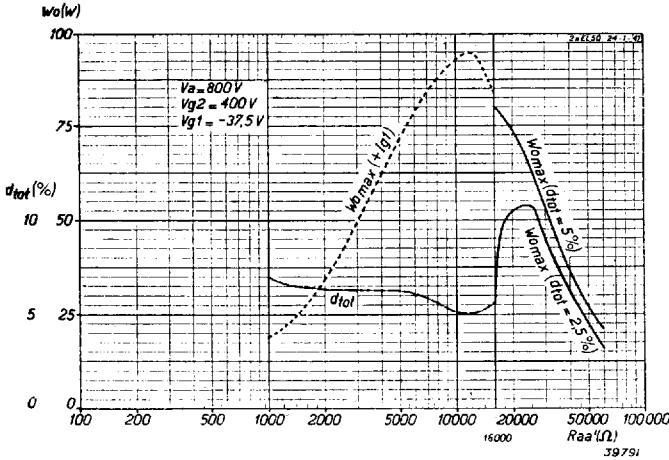

Fig. 10  
Maximum output power  $W_o$  as a function of load resistance  $R_{aa'}$  for two push-pull EL 50 valves with fixed grid bias, at  $V_a = 800 V$ ,  $V_{g2} = 400 V$ ,  $V_{g1} = -37.5 V$ . The broken line  $W_{o\max} (+ I_{g1})$  represents the limit to which the valves can be modulated without grid current flowing, in which case, however, the maximum anode dissipation is exceeded.

**MAXIMUM RATINGS**

Anode voltage in cold condition . . . . .	$V_{ao}$ = max. 1600 V
Anode voltage . . . . .	$V_a$ = max. 800 V
Anode dissipation . . . . .	$W_a$ = max. 18 W
Anode dissipation, on test . . . . .	$W_{at}$ = max. 22 W
Screen grid voltage in cold condition . . . . .	$V_{g20}$ = max. 1000 V
Screen grid voltage . . . . .	$V_{g2}$ = max. 425 V
Screen grid dissipation ( $V_{g1\text{eff}} = 0 V$ ) . . . . .	$W_{g2}$ = max. 3 W
Screen grid dissipation ( $W_o = \text{max.}$ ) . . . . .	$W_{g2}$ = max. 10 W
Cathode current . . . . .	$I_k$ = max. 120 mA
Grid current commences ( $I_{g1} = + 0.3 \mu A$ ) . . . . .	$V_{g1}$ = max. $-1.3 V$
Max. external resistance in grid circuit . . . . .	$R_{g1k}$ = max. 0.7 M Ohms <sup>1)</sup>
Max. external resistance in grid circuit . . . . .	$R_{g1k}$ = max. 0.5 M Ohms <sup>2)</sup>
Max. external resistance between filament and cathode . . . . .	$R_{fk}$ = max. 5000 Ohms
Max. voltage between filament and cathode. . . . .	$V_{fk}$ = max. 100 V <sup>3)</sup>

<sup>1)</sup> With automatic grid bias.  
<sup>2)</sup> With fixed grid bias.  
<sup>3)</sup> D.C. voltage or effective value of alternating voltage.

**APPLICATIONS**

Since this valve is employed almost exclusively in push-pull output stages, only the results obtained in this type of circuit will now be discussed.

In this, distinction is made between circuits with fixed grid bias supplied by a separate rectifier and circuits having automatic grid bias. In the latter category no separate rectifier need be employed, but against this there is the disadvantage that the maximum obtainable output power is usually lower than when fixed bias is applied, this drawback becoming all the more manifest according as the anode voltage is increased. If a very high power output is required, of 50 or even 80 W, automatic grid bias will not therefore be used, the explanation of this being as follows.

The highest possible efficiency, that is, the greatest obtainable output power, is furnished by Class A/B, or to a still greater extent, by Class B circuits. In both types of circuit the valves work at the lower bend of the dynamic characteristic which means that the average anode current varies in accordance with the magnitude of the signal. In the case of automatic bias by means of a cathode resistance, the grid bias then

also varies; to avoid exceeding the value of bias relative to the maximum output power, it therefore would be necessary to start from a lower grid bias setting on zero signal. It would then be found, however, that the resultant standing current, whose value depends on the size of the cathode resistance, would become intolerably high, having regard to the maximum anode dissipation. On the other hand, if a start be made from the permissible operating conditions at zero signal strength, the grid bias increases so rapidly with the signal strength that the anode current is interrupted before the valve is even fully modulated.

The maximum power to be delivered is then limited not by the occurrence of grid current, but by distortion of anode current, which becomes the more marked according as the original operating point is taken lower, with the application of a higher anode voltage. Consequently, automatic grid bias is not practicable at anode voltages of more than 400 V.

When automatic bias is incorporated in a push-pull circuit the starting point for zero signal strength must be such that the maximum anode dissipation can be realised. At 400 V anode, the two valves are made to operate at a level where the total anode current will be 90 mA, when they can be modulated to a depth that will not cause the bias to exceed the permissible limit.

Anode current amplitudes are very much smaller than in the case of a fixed bias, permitting of a higher impedance in the anode circuit without thereby reducing the anode voltage too much and, in this way, the delivered output power is not curtailed so much as would otherwise be the case. The slope of the dynamic characteristic is, however, reduced in consequence of the high resistance in the anode circuit, so that when automatic bias is employed, practically the whole of the grid swing is required for maximum modulation.

At 400 V anode voltage, with fixed bias and an anode load of 5000 Ohms, an output of 50 W is obtained, whereas with automatic bias and a load of 9000 Ohms, the output is only 30 W. In both instances the required alternating grid voltage is about 25 V.

#### *Automatic grid bias*

Provided the anode voltage does not exceed 400 V, the screen grid voltage can be taken directly from the feed circuit, the maximum screen potential being 425 V. Allowing for a voltage drop of 25 V in the speaker transformer<sup>1)</sup>, the rectifier circuit should therefore be capable of delivering 425 V.

The distortion, anode current and screen grid current as a function of output power in respect of these values are shown in Fig. 6. Apart from the total distortion, the individual harmonic distortion values have also been measured. For the output power, the actual output of the valve itself has been taken and in practice, therefore, this value must be reduced to the extent of the losses in the output transformer. From the curves it will be seen that the distortion remains only slight up to an output of 27 W ( $d_{tot} = 2.6\%$ ), but increases appreciably above that figure, up to about 10% at 30 W. As already mentioned, the grid bias sets a limit to the power delivered. Fig. 6 shows that for an output of 30 W the average anode current totals 105 mA with a screen current of 38 mA.

A cathode resistance of 315 Ohms will produce a voltage of 45 V which is sufficient to quench the anode current; at still greater modulation depths both valves would then cease to pass anode current and the speech current would be correspondingly interrupted. The marked increase in 5th harmonic in Fig. 6 already points in this

<sup>1)</sup> This approximation is arrived at in the following manner. The matching resistance of the primary side of the speaker transformer is usually in the neighbourhood of 10,000 Ohms. Assuming the losses in the winding to be 10% of the output power, the total loss-resistance will be about 1000 Ohms. As a rule this resistance is distributed gradually throughout both primary and secondary windings, so that the loss in the primary alone is about 500 Ohm, corresponding to at least one half of the winding, seeing that the current alternates between the two halves of the transformer. Now, if the current of the one valve averages 50 mA, there will be a voltage drop of 25 V across the transformer winding.

direction. This type of distortion is very troublesome and limits the maximum obtainable output power just as much as the effect of grid current.

*Fixed grid bias*

A fixed grid bias will commence to show an advantage only at an anode voltage of at least 400 V; whereas Fig. 6, shows that an output power of 30 W is obtainable with automatic bias this becomes 50 W at that anode voltage.

Operating details for the EL 50 in a Class A/B circuit with fixed grid bias are given on page 184.

Fig. 7 shows the anode and screen voltage curves as well as the distortion at  $V_a = 400$  V, as function of the output power. The most satisfactory value for the grid bias is  $-35$  V, in which case the best matching resistance between the two anodes is 5000 Ohms. At maximum modulation, the output is 50 W with a total distortion of 3.4%, at which level the screen grid current runs to a value that is just within the permissible limits. The relation between optimum output and the most satisfactory matching resistance for a given setting of the valve is given in Fig. 8.

For values of the anode voltage other than 400 V, details are given in Fig. 11. At voltages above 400 V, the screen grid voltage must be dropped to the maximum rated value by means of a potentiometer; owing to the increase in screen grid current when the valves are modulated, the supply voltage will be reduced by the resistance of the potentiometer itself, this limiting the maximum available output power. This limiting effect becomes the more marked as the anode voltage is raised and at higher voltages it is therefore desirable to stabilise the screen voltage as much as possible, as borne out by the figures given for an anode potential of 800 V.

When the output valves are modulated to the point where grid current flows, an output of 84 W can be attained, provided the screen grid voltage is kept constant at 400 V, with  $-37.5$  V bias and  $R = 16000$  Ohms. The curves relative to these operating conditions are shown in Fig. 9; the total distortion is 6.6 %.

If the screen grids are fed from a potentiometer which itself absorbs 40 mA, the screen

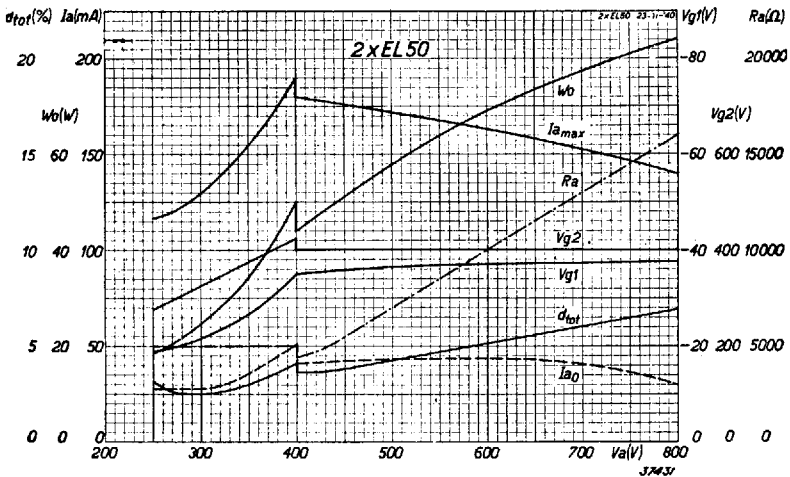

Fig. 11  
Maximum anode current  $I_{ama}$ , standing current  $I_{a0}$ , screen voltage  $V_{g2}$ , grid bias  $V_{g1}$ , output power  $W_o$ , total distortion  $d_{tot}$  and optimum output impedance  $R_a$  as a function of available anode voltage  $V_a$  of two EL 50 valves in a push-pull circuit with fixed grid bias.

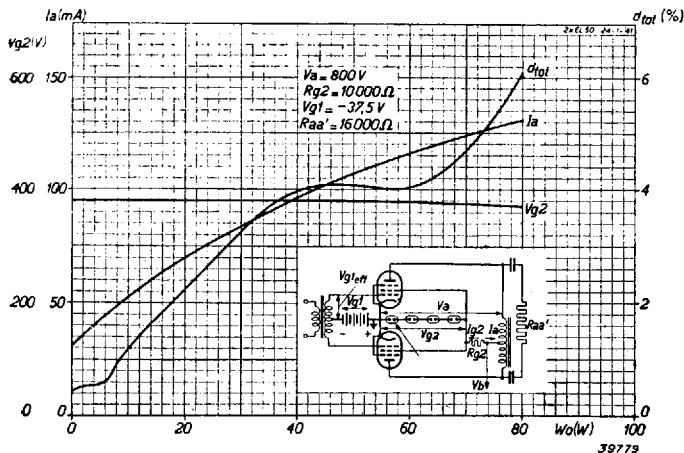

Fig. 12  
 The same curves as in Fig. 9, but with respect to the case where the screen voltage is taken from the 800 V supply line across a resistance of 8000 Ohms, being maintained at a constant value by 4 stabiliser tubes type 13201.

grid voltage falls to such an extent under modulation conditions that the maximum output obtainable is only 50 W, due to the displacement of the dynamic characteristic, and this output can also be obtained on an anode voltage of 400 V. It is therefore very necessary to stabilise the screen grid voltage and this may be done by tapping the voltage from the 800 V supply across a resistance of 8000 Ohms and placing four series-connected stabiliser tubes, Type 13201, in parallel with the screen grids. This will keep the voltage sufficiently constant at 380 V and ensure an output of 80 W at maximum modulation. The relative curves are shown in Fig. 12 and it will be seen that they are not very different from these in Fig. 9. Fig. 10 illustrates the relation between the maximum output and the load resistance.

#### Feeding the amplifier

A push-pull output stage with automatic grid bias will generally not give rise to so many difficulties as the same circuit with fixed bias. The screen grids are then fed directly from the power section and the average anode current is practically independent of the power delivered; the rectifier need not therefore conform to any special requirements. At 400 V anode, the output stage, on maximum modulation, consumes  $105 + 40 = 145$  mA which can be supplied by a Type AX 50 rectifier valve, this having a D.C. output of 250 mA which is sufficient for the preceding amplifier valves as well.

For stages with fixed bias in which the average anode current varies considerably with the amplitude of the signal, it is preferable to employ a rectifier circuit having the lowest possible internal resistance, more especially when applicable to 400/425 V operation, in view of the fact that the screen grid voltage is then not stabilised and both anode and screen grid voltages decrease on a rising amplitude. The feed voltage must not be increased in advance, as the maximum screen grid potential would then be exceeded on weak signals.

The gas-filled valve AX 50 is very suitable for the power supply, by reason of its very low internal resistance, provided the smoothing filter does not include a reservoir condenser. The total internal resistance is then equal to that of the choke coil plus the resistance of half the transformer winding: assuming that this is not more than 200 Ohms, an increase of 200 mA in the total current will produce a voltage drop of 40 V. Fig. 11 shows that in this case the optimum output power will be 36 W instead of 50 W, so efforts should be made to reduce the internal resistance still further. On

800 V anode, with stable screen grid voltage, the internal resistance causes a drop of 30 V, yielding an output of 82 W, instead of 84 W.

The AX 50 is inadequate for these operating conditions and the output stage should then be fed from 2 types DCG 2/500 rectifiers of which details are as follows:

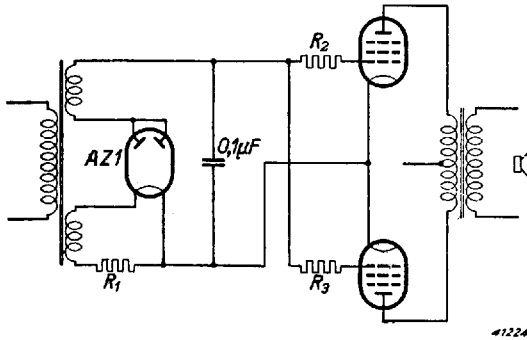

Fig. 13

Circuit employed to obtain fixed grid bias for two push-pull output valves EL 50.

Heater voltage  $V_f = 2.0$  V  
 Heater current  $I_f = 4.5$  A.

Full-wave rectification, on an alternating anode voltage of 1050 V<sub>eff</sub> gives a maximum D.C. output of 950 V at a maximum of 300 mA.

The method of obtaining screen grid voltage in this instance has already been given: four stabiliser tubes 13201 connected in series are placed in parallel with the screen grids. This combination of 4 tubes ensures a constant working voltage of 380 V over a relatively wide current range. The voltage drop across

the series resistance is then 420 V and, if a resistance of 8000 Ohms is used, the screen grids and stabilisers together must take a current of 52 mA.

In the absence of an input signal the total screen grid current will be about 2 mA, in which case the stabilisers dispose of the remaining 50 mA. At maximum modulation, the screen grids pass a current of 38 mA, leaving 14 mA for the stabilisers, which is just sufficient for efficient stabilisation.

For the grid bias, the arrangement shown in Fig. 13 is recommended, for which purpose the mains transformer should have a separate winding to provide a voltage of

$$V_{eff} = \frac{V_g}{\sqrt{2}}$$

The AZ 1 is suitable as rectifier, the filament being connected in series with a resistance  $R_1$  and in parallel with the heaters of the other valves. In practice this circuit will give rise to no difficulties whatsoever.



## X. Universal 26 W amplifier

*Valves used:* CF 50, EBF 2, ECH 4, 4699, 4699, AX 1.

The amplifier based on this circuit will deliver an output of 26 W at only 3.5% distortion and can be employed in practically every case where sound amplification is required. Provision is made for the simultaneous or separate connection of the following, to 4 sets of input terminals:

- A) microphone
- B) output of a radio receiver
- C) a telephone line
- D) an electric gramophone pickup.

The input channels are so arranged that every possible combination of the above can be employed at one time; for instance, microphone announcements can be made during radio or gramophone programmes without interrupting the latter, each input channel having its own separate volume control.

A main volume control is also provided, for adjustment of the combined output without affecting the proportions of the different sources of sound. Two variable tone controls are fitted, to regulate the overall relationship of high to low tones from the different channels, whilst the microphone input has a separate tone filter, operated by a switch. The system of negative feed-back, together with the tone controls just mentioned, ensures an excellent response curve (see Fig. 2, curve 1).

To avoid the possibility of overloading in the event of a sudden increase in the input signal (extra loud passages in the speech or music), a continuously variable automatic compression circuit is included.

The input sensitivity of the different channels is as follows:

- A) microphone 0.85 mV
- B) radio 1.2 V
- C) telephone 300 mV
- D) gramophone 150 mV

### Description of the circuit

#### *Output stage*

The output stage consists of two amplifier pentodes type 4699 in a push-pull circuit, automatic grid bias being provided by a common cathode resistance  $R_{52}$ . Damping resistances ( $R_{50}$ ,  $R_{54}$  and  $R_{55}$ ,  $R_{56}$ ) are included in the control and screen grid circuits; the screen grid voltage is 425 V. At maximum modulation, these valves are capable of an output of 26 W, with 3.5% harmonics.

In some instances, hum may prove a troublesome factor and this can be overcome by earthing one end of the heater winding (*c-c*) of the power transformer, instead of the centre tap. In that case a ripple voltage is produced between the cathode and control grid of the output valves, in counter-phase with the ripple occurring in the amplifier itself.

The two input voltages for the output stage are provided by the triode-heptode ECH 4.

#### *Phase inversion*

The heptode section of the ECH 4 is employed to provide the control voltage for one of the output valves, whilst the triode unit, with unity gain, acts as phase-inverter in supplying the control voltage for the other. Due to the strong negative feed-back across  $R_{43}$ , which also serves to prevent distortion in the phase-inversion stage, the amplification factor in this stage is constant at unity, apart from any valve tolerances. The use of the ECH 4 as phase-inverter dispenses with the usually costly driver transfor-

mer. The high D.C. voltage available in the amplifier makes it possible for the ECH 4 to deliver the alternating voltage of 12.5 V required for maximum modulation of the output stage, without any additional distortion. The gain of this stage is about 100 which means that an alternating voltage of  $\frac{12.5}{100} \times 3 = 0.375$  V is required at the ECH 4 (the negative feed-back factor being of the order of 3, see p. 195).

#### *Pre-amplification stage*

All the input channels are pre-amplified by the double diode pentode EBF 2 in the pre-amplifier stage: one of the diodes of this valve is employed for the contrast compression as described later.

In the anode circuit there are three tone controls, in parallel with the anode-coupling resistance  $R_{27}$ , serving for any required adjustment of the response curve. The first of these comprises the condensers  $C_{19}$ ,  $C_{20}$ ,  $C_{21}$  and  $C_{22}$  (Fig. 1): these are for attenuation of the lower frequencies and are operated by means of a 4-way switch. The second tone control is not variable and serves to enhance the high note response, consisting of a resistance  $R_{28}$  with condenser  $C_{24}$ . The third filter,  $R_{34}/C_{26}$  is continuously variable and is used for attenuation of the higher frequencies.

The main volume control is also in parallel with the anode-coupling resistance  $R_{27}$  and, as stated, controls the amplification of all input signals without altering their relative proportions. Due to the presence of the volume control in parallel with the anode resistance, the amplification factor is reduced somewhat, this being 12.5. The alternating input voltage is therefore  $\frac{0.375}{12.5} = 0.03$  V. The cathode of the EBF 2 carries a positive potential of 27 V with respect to earth, this having the effect of delaying the contrast compression.

#### *Input channels*

The different input channels are designated in the circuit diagram as *A*, *B*, *C* and *D*.

- A*) The microphone channel is suitable for various types of microphone, including the less sensitive varieties such as the ribbon, crystal and condenser. This is made possible by using the pentode CF 50 with its low hum and noise levels combined with variable amplification, the latter being controlled by potentiometer  $R_6$  which renders the control grid more, or less negative, with respect to the cathode.

Grid bias is obtained by connecting the cathode to a positive potential (junction of  $R_{15}$ ,  $R_{16}$ ) and special measures are taken in smoothing the bias: resistances  $R_2$  and  $R_3$  in combination with condensers  $C_3$  and  $C_4$ , form a double smoothing filter, apart from which an electrolytic condenser of 150  $\mu$ F ( $C_8$ ) is placed across the whole of the cathode voltage. To avoid any tendency towards hum introduced by long microphone cables, an electrolytic condenser of 25  $\mu$ F is employed for  $C_2$ , this offering a low impedance with respect to earth. The maximum amplification of the CF 50 is so high that only a part of it can be utilised and the anode resistance  $R_{22}$  is therefore of a relatively low value (56,000 Ohms). Resistance  $R_{21}$  is included to prevent the anode circuit of the CF 50 and the radio, telephone and gramophone channels from affecting each other and causing interference. Condenser  $C_{13}$  can be bypassed by a switch to suppress the lower tones of the microphone signal if necessary (Fig. 3).

- B*) The radio input channel is a low resistance circuit, permitting the secondary side of the output transformer of a receiver to be connected to terminals *B*. Many receivers work with inverse A.F. feed-back tapped from the transformer winding

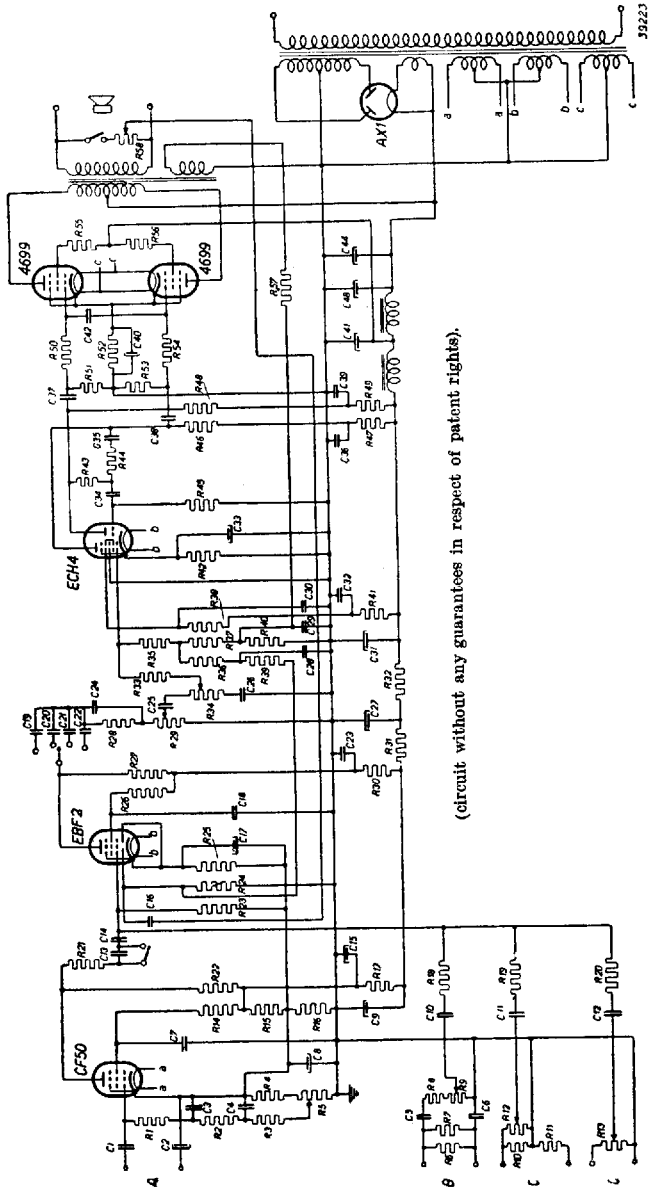

(circuit without any guarantees in respect of patent rights).

Fig. 1  
Circuit diagram of a 20 W universal amplifier

*Resistances*

R1 =	0.82 M Ohms
R2 =	0.22 „
R3 =	0.47 „
R4 =	1,200 Ohms
R5 =	10,000 „
R6 =	39 „
R7 =	39 „
R8 =	33,000 „
R9 =	50,000 „
R10 =	330 „
R11 =	330 „
R12 =	10,000 „
R13 =	50,000 „
R14 =	0.56 M Ohms
R15 =	33,000 Ohms
R16 =	3,300 „
R17 =	4,700 „
R18 =	1 M Ohms
R19 =	0.22 „
R20 =	0.22 „
R21 =	0.15 „
R22 =	56,000 Ohms
R23 =	0.68 M Ohms
R24 =	0.56 „
R25 =	1,200 Ohms
R26 =	0.33 M Ohms
R27 =	0.1 „
R28 =	0.12 „
R29 =	0.2 „
R30 =	0.1 „
R31 =	3,300 Ohms
R32 =	3,300 „
R33 =	1 M Ohms
R34 =	0.5 „
R35 =	0.47 „
R36 =	0.47 „
R37 =	0.47 „
R38 =	0.39 „
R39 =	0.47 „
R40 =	100 Ohms
R41 =	0.1 M Ohms
R42 =	470 Ohms
R43 =	1 M Ohms
R44 =	1 „
R45 =	1 „
R46 =	0.33 M Ohms
R47 =	22,000 Ohms
R48 =	0.1 M Ohms
R49 =	22,000 Ohms
R50 =	82 „
R51 =	0.68 M Ohms
R52 =	180 Ohms

R53 =	0.68 M Ohms
R54 =	82 Ohms
R55 =	82 „
R56 =	82 „
R57 =	8,200 „
R58 =	10,000 „

*Condensers*

C1 =	0.1 $\mu$ F
C2 =	25 „
C3 =	0.1 „
C4 =	0.37 „
C5 =	0.27 „
C6 =	0.27 „
C7 =	0.2 „
C8 =	150 „
C9 =	16 „
C10 =	0.1 „
C11 =	0.1 „
C12 =	0.1 „
C13 =	3,300 $\mu$ $\mu$ F
C14 =	0.1 $\mu$ F
C15 =	16 „
C16 =	2 „
C17 =	50 „
C18 =	0.1 „
C19 =	470 $\mu$ $\mu$ F
C20 =	680 „
C21 =	2,200 „
C22 =	1,2000 „
C23 =	0.2 $\mu$ F
C24 =	270 $\mu$ $\mu$ F
C25 =	0.1 $\mu$ F
C26 =	470 $\mu$ $\mu$ F
C27 =	16 $\mu$ F
C28 =	0.5 „
C29 =	60,000 $\mu$ $\mu$ F
C30 =	0.1 $\mu$ F
C31 =	16 „
C32 =	0.1 „
C33 =	50 „
C34 =	10,000 $\mu$ $\mu$ F
C35 =	20,000 „
C36 =	0.1 $\mu$ F
C37 =	10,000 $\mu$ $\mu$ F
C38 =	10,000 „
C39 =	0.1 $\mu$ F
C40 =	50 „
C41 =	16 „
C42 =	68 $\mu$ $\mu$ F
C44 =	16 $\mu$ F
C48 =	16 „

in question and, to avoid short-circuiting any D.C. voltages between this winding and earth when connecting the receiver to the amplifier, condensers  $C_5$  and  $C_6$  are included in the circuit.

- C) Two resistances  $R_{10}$  and  $R_{11}$  are connected across the telephone input terminals, the junction of these being earthed: this prevents one side of the telephone line from being directly earthed.
- D) The gramophone input channel consists of a potentiometer  $R_{13}$ .

Input terminals  $B$ ,  $C$  and  $D$  are taken directly to the control grid of the EBF 2 without any switches, in order to avoid the possibility of crackle during change-overs or mixing of the programmes, as switches would doubtless introduce this. As each of the different channels has its own separate volume control, they might show a tendency—according to the settings of these controls—towards interaction, and a resistance is therefore shown in series between each of the channels and the control grid of the EBF 2 ( $R_{18}$ ,  $R_{19}$ ,  $R_{20}$ ). Needless to say, these resistances reduce the sensitivity, the attenuation factor in respect of gramophone reproduction being about 5, but this is taken into account in the overall amplification. The series-resistance  $R_{18}$ , in the radio input, is of a higher value than that of  $R_{19}$  and  $R_{20}$  in the telephone and gramophone channels, since sensitivity in this instance does not enter into the question and there is then less likelihood of the radio side interfering with any of the other channels.

#### *Negative feed-back*

A small separate coil is incorporated in the output transformer, from which the potential for the negative feed-back is tapped, for passing by way of the frequency-dependent circuit  $R_{57}$ ,  $R_{40}$ ,  $C_{29}$  and resistances  $R_{37}$  and  $R_{35}$ , to the control grid of the ECH 4. This separate feed-back coil is indispensable, since the impedance of the secondary winding of the output transformer is not constant, but varies with the load. The purpose of  $R_{33}$  is to prevent the setting of the potentiometer for the main volume control  $R_{29}$  and the tone control  $R_{31}$  from counteracting the negative feed-back. The values of  $R_{36}$  and  $R_{39}$  are also such that the feed-back will not be affected by them. It should be noted that the negative feed-back potential cannot be returned to the cathode of the ECH 4, since this would produce both positive and negative feed-back.

#### *Automatic contrast compression*

Contrast compression is provided to check distortion arising from any sudden variations in sound. To this end a potentiometer of 10,000 Ohms is connected across the secondary coil of the output transformer, thus returning a larger or smaller portion of the output voltage, through  $C_{16}$ , to one of the diodes of the EBF 2. The rectifying action of this diode produces a D.C. voltage across  $R_{24}$  which is applied across  $R_{30}$ ,  $R_{36}$  and  $R_{35}$  to the control grid of the ECH 4. The potential of the cathode of the EBF 2 in respect of earth is the same as that of the CF 50 and the contrast compression diode thus receives a negative bias which functions as delay voltage. If however the kink in the compression curve is too high up, the resultant reproduction may be unpleasant, and this must be avoided: in effect, normal contrasts would then be produced on weak signals whereas strong signals would be rendered without contrast. The delay voltage is about 35 V which means that the compression commences to operate at an output of about 5W and, due to this compression circuit, the input voltage is able to rise to a strength of about 4 times higher at maximum modulation, without any appreciable increase in the distortion (see table).

Output power W	Without compression		With compression	
	Input voltage mV <sub>eff</sub>	Distortion %	Input voltage mV <sub>eff</sub>	Distortion %
26	150	3.5	690	5
20	120	2.1	430	3.9
15	100	1.5	274	3.7
10	76	1	155	3.3
5	52	0.6	64	2.2

### *Tone control*

The anode circuit of the EBF 2 includes two variable tone controls and, further, a condenser with switch is fitted in the anode circuit of the CF 50 for suppression of the lower tones of microphone reproduction. When the high-tone filter  $R_{24}-C_{26}$  is fully operative, that is, with the sliding contact of the potentiometer at the junction of this resistance and condenser, the attenuation at a frequency of 5000 c/s is about 75 % and at 400 c/s only about 20 %. The filter for suppression of the lower tones consists of the condensers  $C_{19}$ ,  $C_{20}$ ,  $C_{21}$  and  $C_{22}$  and the effect of this tone control upon the response curve is shown in Fig. 2. In Fig. 3 the frequency characteristics for microphone reproduction, with and without condenser  $C_{13}$  in circuit, are shown.

### *Volume control*

The resistance of the main volume control  $R_{29}$  must not exceed 0.2 M ohms; if it is any higher, the grid impedance of the ECH 4 is subjected to too wide a variation. This in turn affects the negative feed-back and tone control and produces irregularities in the frequency characteristic.

### *Supply*

Owing to the push-pull circuit in the output stage, the anodes of the two output valves can be fed from the first electrolytic condenser in the smoothing circuit, the advantage of this being that the choke need not be very large, since the direct current for the pre-amplifier is relatively low. Electrolytic condensers  $C_{43}$  and  $C_{44}$  are of 16  $\mu$ F each, with 450 V breakdown voltage. It may appear strange that two condensers in parallel are employed instead of a single 32  $\mu$ F condenser of the same breakdown voltage, but when the direct current is applied, the voltage surges for a moment beyond 450 V and a single condenser might possibly sustain damage. The use of two condensers in parallel ensures a higher leak current which temporarily replaces the normal load and prevents injurious overloads.

The primary and secondary windings of the power transformer are screened from each other for the purpose of blocking the path of any R.F. interference in the A.C. mains from penetrating to the amplifier and producing distortion.

The internal resistance of the gas-filled rectifier is extremely low, this being a great advantage in fairly high-powered amplifiers. With a view to preventing any possible trouble due to ripple, it is advisable to mount the power transformer as far as possible from the different input circuits: the field which extends from the transformer over the chassis is otherwise very liable to cause hum, especially if the layout of the latter is at all compact.

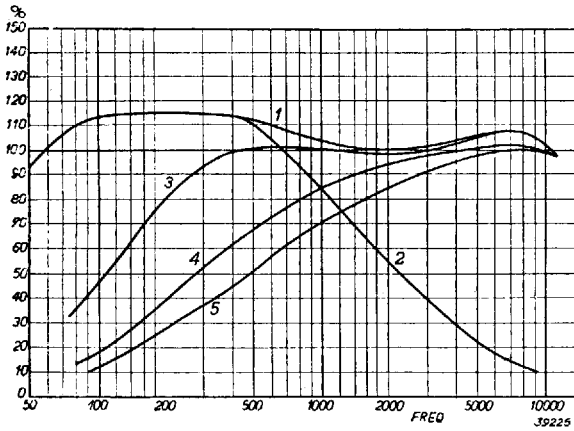

Fig. 2  
Frequency characteristic of the amplifier.

Curve 1; Tone controls for the high and low tones inoperative ( $C_{22}$  in circuit).  
 Curve 2. Tone control for the high tones ( $R_{32}-C_{12}$ ) operative.  
 Curve 3. Tone control for high tones inoperative,  $C_{21}$  in circuit.  
 Curve 4. Tone control for the high tones inoperative,  $C_{20}$  in circuit.  
 Curve 5. Tone control for the high tones inoperative,  $C_{13}$  in circuit.  
 By means of the condensers  $C_{19}$ ,  $C_{20}$  and  $C_{21}$  the lower frequencies are thus suppressed as required.

Finally, it may be said that the leads to the control grids of the CF 50 and EBF 2 valves should be screened and the screening effectively earthed. Faulty positioning of the control grid lead on the CF 50 will result in hum and it is therefore advisable to mount this in such a way that it can if necessary be readjusted later. Any tendency towards microphony in the CF 50 should be avoided by mounting this valve in an efficient anti-vibration valveholder.

**TECHNICAL DATA**

*Sensitivity* (measured at 500 c/s)

Signal input for full modulation of the output valves:

- at the output stage . . . . . 12.5 V
- at the ECH 4 . . . . . 0.375 V
- at the EBF 2 . . . . . 0.03 V
- at the input for the gramophone pickup 150 mV
- at the input for the telephone line . . 300 mV
- at the input for the radio . . . . . 1.2 V
- at the microphone input . . . . . 0.85 mV

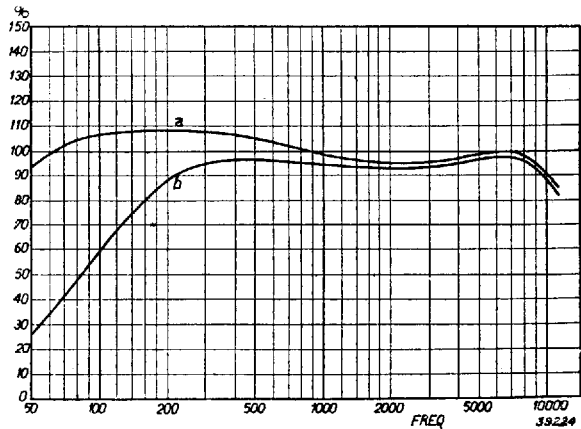

Fig. 3  
Frequency characteristic of the amplifier, with condenser  $C_{13}$  inoperative (curve *a*) and operative (curve *b*). (Suppression of the low tones in microphone reproduction).





**Latest Philips  
measuring and ancillary equipment  
for  
laboratories, test-rooms and workshops**

## Philips signal generator GM 2307



Philips Signal Generator GM 2307 delivers a very constant alternating voltage of variable amplitude. It can be employed for every type of practical measurement within the frequency range of 30 to 16,000 c/s.

The test frequency is produced by mixing the signals from two R.F. oscillators, the resultant beat frequency which is equal to the difference between the frequencies of the two R.F. voltages being subsequently amplified.

### TECHNICAL DATA

#### *Frequency range*

The frequency control on the right hand side of the panel covers a range of 0 to 1000 c/s and the left hand control 0 to 15,000 c/s; the readings of both scales are additive and when both are at their maximum settings the frequency is 16,000 c/s.

#### *Frequency curve during warming-up period*

Ten minutes after switching on the generator, and for the next three hours, the frequency drift is less than 20 c/s; after this period the variation is negligible.

#### *Calibration and accuracy of the scales*

With both scales set to 0, the beat frequency is adjusted to zero with the aid of the electronic indicator and the subsequent accuracy of the scales, between 200 and 16,000 c/s is  $\pm 1\%$ , with a maximum deviation of 2 c/s between 30 and 200 c/s.

#### *Frequency characteristic of the A.F. generator*

As will be seen from the accompanying curve, the characteristic is straight to within less than  $2\frac{1}{2}\%$  between 30 and 16,000 c/s; this applies at all settings of the matching switch.

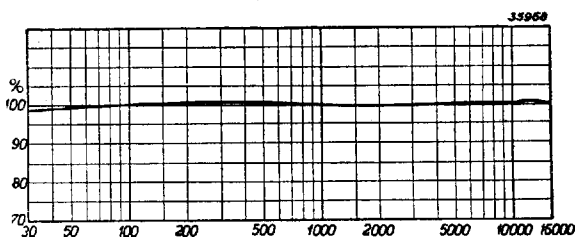

#### *Matching*

The output stage of the instrument can be matched with the following loads by means of the switch provided:

- 1) attenuator in circuit <sup>1)</sup>
- 2) output resistance 1000 Ohms <sup>2)</sup>
- 3) output resistance 500 Ohms <sup>2)</sup>
- 4) output resistance 250 Ohms <sup>2)</sup>
- 5) output resistance 5 Ohms <sup>2)</sup>
- 6) maximum normal voltage: approx. 50 V; output resistance about 100,000 Ohms <sup>3)</sup>.

<sup>1)</sup> By means of a switch, the output voltage can be adjusted for symmetry or asymmetry with respect to the earth terminal.

<sup>2)</sup> The lower terminal can be earthed as desired by means of a switch.

<sup>3)</sup> At this setting, the lower terminal must always be earthed by means of the appropriate switch.

### *Attenuator*

The attenuator incorporated in this instrument operates in 9 stages and the total attenuation factor of the output voltage is 10,000. Individually, the stages are as follows:  $3 \times 10^{-1}$ ,  $10^{-1}$ ,  $3 \times 10^{-2}$ ,  $10^{-2}$ ,  $3 \times 10^{-3}$ ,  $10^{-3}$ ,  $3 \times 10^{-4}$ , and  $10^{-4}$  times the input voltage, equivalent approximately to 10 dB per stage. Normally, the input voltage is 0–15 V, as measured at the terminals at the left hand side of the unit by means of a valve-voltmeter, for example Philips R.F. triode voltmeter GM 4151, or Philips thermionic voltmeter GM 4132.

The output voltage is taken from the terminals on the right hand side and the load between these terminals should be at least 25,000 Ohms. A switch is provided to render the output voltage symmetrical with respect to earth, or not, as required, and in both cases the potential between the output terminals is the same, any differences being less than 2 %. When the switch is turned to "asymmetrical", the lower terminal is simultaneously earthed.

### *Accuracy of the attenuator*

With the input voltage correctly adjusted, the attenuated voltage in the different stages does not vary more than 1 % from the nominal.

### *Maximum output power, distortion*

When the load is correctly matched, the maximum output power at settings 2 to 5 of the matching switch is normally approximately 200 mW. For special purposes, the maximum power of the instrument may be increased, however, to 1 W, or reduced to 100 mW, by adjusting a set-screw at the rear of the instrument. The distortion then varies in accordance with the following values:

Frequency	Distortion at		
	100 mW	225 mW	1 W
30— 200 c/s	0.5 %	1 %	2.5 %
200—16,000 c/s	0.25 %	0.5 %	1.5 %

With the voltage control set to maximum, the ripple for an output voltage of 15 V is less than 0.5–1 %.

### *Calibration of the voltage control*

The voltage available at the left hand terminals, with the matching switch in positions 1 and 2 may be read direct from the scale on the control knob. The maximum voltage of all these instruments is adjusted to 15 V *eff*, but can be readjusted between about 10 and 32 V by means of a set screw at the rear of the generator. This voltage is independent of fluctuations in the temperature or mains voltage supply. For very accurate work, the voltage is measured at the left hand terminals.

### *Supply*

A voltage tapping switch is provided at the back of the unit, by means of which the transformer can be adjusted for 110, 125, 145, 200, 220 or 245 V, 40–100 c/s. The consumption is approx. 40 W.

### *Effect of mains voltage fluctuations*

Variations in the output voltage, due to 10% fluctuations in the mains supply are less than 2 %.

*Use with vibratory converter*

In conjunction with the "Vibraphil" type 7710 vibratory converter the instrument can be operated on D.C. mains of 110—145 V, or with the "Vibraphil" type 7711 on 220—245 V. D.C.

*Valves:*

Triode-hexode . . . . .	<i>ECH 3</i>
Pentode . . . . .	<i>EF 6</i>
A.F. Pentode-electronic indicator	<i>EFM 1</i>
Pentode . . . . .	<i>EL 3</i>
Rectifier . . . . .	<i>EZ 2</i>
Neon stabiliser tube . . . . .	<i>150 A 1.</i>

*Weight and dimensions:*

Weight: approx.	<i>12 kg</i>
Width: „	<i>34 cm</i>
Height: „	<i>25.5 cm</i>
Depth: „	<i>20 cm (incl. knobs).</i>

## Philips Service Oscillator GM 2882

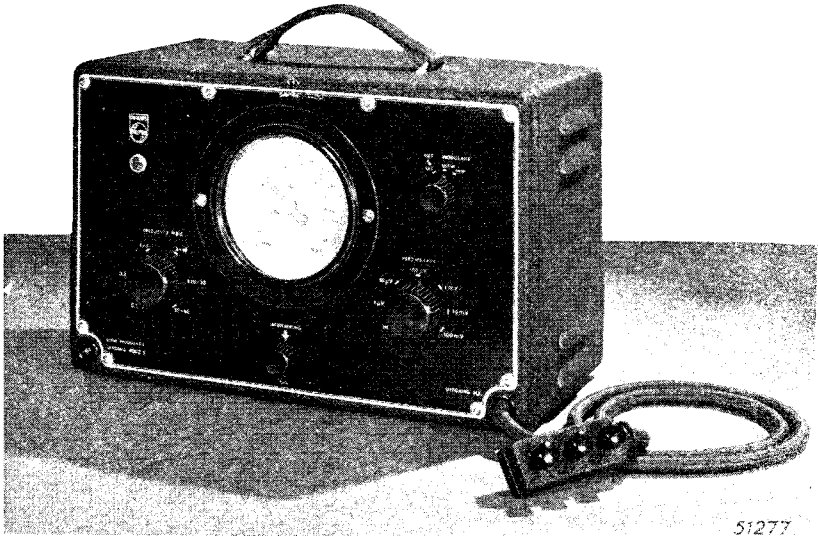

By reason of its very special features, the Philips Service Oscillator Type GM 2882 is an extremely handy instrument. A direct reading of the frequency in kc/s or Mc/s is obtained from the scale. The attenuator furnishes an indication of the output voltage and this oscillator is therefore eminently suitable for the calibration of station dials, the tuning of receivers and checking of sensitivity, automatic volume controls and silent tuning devices.

The overall scope of the unit is 100 kc/s to 60 Mc/s, this being divided into 6 ranges. Between  $1\mu V$  and 100 mV the output voltage is continuously variable and the connecting cable for use in selectivity testing is equipped with an attenuator calibrated in stages of 1 : 10. A built-in modulator is included, by means of which the output voltage can be modulated with 400 c/s to a depth of 30 % whilst it is also possible to apply a modulation voltage from an external source to a total depth of 80 % of the signal. The oscillator is equipped with a dummy aerial, and numerous measures have been taken in the construction to ensure the highest possible stability of the frequency. Oscillator coils and associated switches have been so designed as to render the leads in each wave-range as short as possible, the coils being mounted on a rotary disc, adjustable to six different positions by means of a knob and each time placing a different coil in circuit. Each coil thus has the same short connections to the tuning condenser and oscillator valve, ensuring high frequency stability, both mechanically and electrically. The oscillator coils themselves are constructed so as to have a negative temperature coefficient, to compensate the positive coefficient of the tuning condenser. A very high degree of independence of the oscillator circuit can therefore be claimed with respect to the effects of temperature.

Owing moreover, to the use of the high mutual conductance pentode EF 50, which was specially designed for very high frequencies, the oscillator frequency is practically unaffected by mains voltage variations. In order that the oscillator valve may be isolated from the attenuator, a separate valve is used; the frequency cannot therefore be affected by the setting of the attenuator. Frequency modulation is avoided by the

use of a special circuit which ensures that the modulation remains practically undistorted, even at very high frequencies. The degree of accuracy of the scale readings is approximately 1 % and this is usually ample for the trimming of radio receiver circuits. An ingenious potentiometer circuit makes it possible to operate the attenuator by means of a single control knob, there being only 4 controls on the entire unit, viz.:

- 1) Wavelength switch.
- 2) Tuning control.
- 3) Attenuator.
- 4) Mains switch, combined with internal modulation control.

#### *Scale*

The scale is calibrated in kc/s and Mc/s to a tolerance of 1 % and ensures great accuracy in reading.

#### *Constancy of the frequency*

It is of the greatest importance that the frequency remains as constant as possible in all circumstances. With mains voltage variations of 10 % the frequency is constant to within 0.02 % and on an increase in temperature up to 10° C, within 0.1 %, in other words, the reliability of the frequency is even greater than the accuracy of the scale.

### **TECHNICAL DATA**

#### *Frequency ranges*

- |                  |               |
|------------------|---------------|
| 1) 100—300 kc/s  | 4) 3—10 Mc/s  |
| 2) 300—1000 kc/s | 5) 10—30 Mc/s |
| 3) 1—3 Mc/s      | 6) 30—60 Mc/s |

#### *R.F. voltage*

The maximum R.F. voltage delivered is 100 mV.

#### *Attenuator*

By means of the attenuator, the signal can be gradually reduced to less than 1  $\mu$ V, the connecting cable being further coupled to an attenuator with switch, calibrated to a ratio of 1 : 10.

#### *Modulation*

The signal may be modulated with 400 c/s to a depth of 30 % with the built-in oscillator, or with a separate oscillator to 80 %, at frequencies up to 10,000 c/s.

#### *A.F. voltage*

The A.F. voltage for internal modulation may be tapped from the external modulation terminals; this voltage is 1.5 V and the frequency is 400 c/s.

#### *Valves*

Oscillator	EF 50	Rectifier	EZ 2
Modulator valve	EF 50	Pilot lamps	8092 D-07.
A.F. oscillator	EF 6		

#### *Mains supply*

The unit is suitable for operation on all mains voltages, viz. 110, 125, 145, 200, 220 and 245 V,  $\pm$  10 %, 50—100 c/s. The instrument is fully mains driven.

#### *Consumption*

18 W.

#### *Dimensions:*

Width 33.3 cm  
Height 22 cm  
Depth 16.5 cm

#### *Weight:*

8.5 kg

## Philips thermionic voltmeter GM 4132

This is a high resistance voltmeter having a very wide range of measurement. The high parallel resistance of  $1.2\text{ M ohm}$  and the extended range of  $1\text{ mV}$  to  $300\text{ V}$  gives this unit a very wide field of application, such as measurements in sound amplifiers, small transformers, telephone lines, etc. The circuit consists of an attenuator of  $1.2\text{ M ohm}$  across the input, in conjunction with a 2-stage amplifier; the output voltage of this amplifier is rectified and passed to a moving-coil meter. As the voltage on the instrument is automatically limited by the amplifier, the voltmeter is impervious to heavy overloads, even in the event of its being connected to  $300\text{ V}$  while switched for  $10\text{ mV}$ . The meter itself is a robust precision instrument, of which the coil is pivoted on sapphire bearings. The magnet is made from a new type of steel which guarantees a very intense field.

A knife-edge pointer and mirror scale are provided for parallax-free reading, whilst the high degree of damping produces a dead-beat indication for quick reading. The scale calibration is practically linear from zero to the maximum deflection, giving the greatest possible accuracy of measurement; the length of the scale is  $11.5\text{ cm}$  and the instrument may be used either vertically or horizontally.

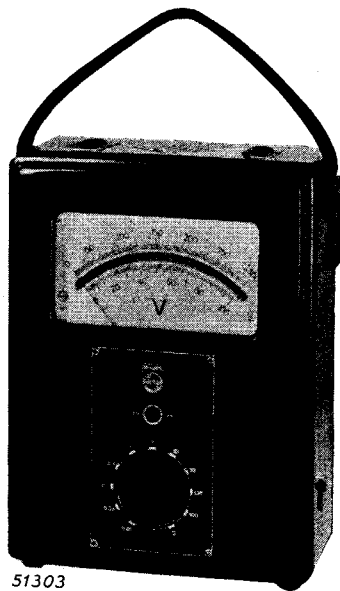

### TECHNICAL DATA

#### *Range of measurement*

The meter is suitable for A.C. measurements of  $1\text{ mV}$  to  $300\text{ V}_{eff}$  in 10 stages, each of which overlaps. If a D.C. component is present, this should be filtered out by means of a condenser.

#### *Accuracy*

The scale is calibrated for a pure, sinusoidal voltage; between  $25$  and  $10,000\text{ c/s}$ , at full deflection of the needle, the error is less than  $2\%$ , between  $10,000$  and  $15,000\text{ c/s}$  less than  $3\%$ .

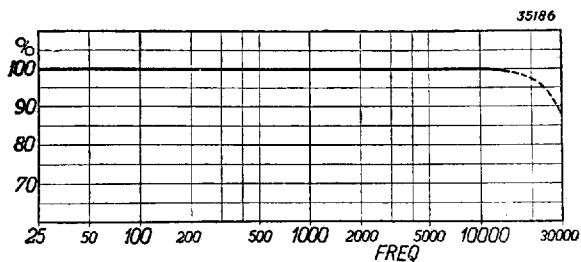

Frequency characteristic of the instrument.

#### *Frequency range*

From  $25$  to  $15,000\text{ c/s}$ . The accompanying curve shows the meter characteristic within this range and the deviation at frequencies above  $15,000\text{ c/s}$ .

#### *Parallel resistance*

This is constant at  $1.2\text{ M ohm}$  which, in the  $300\text{ V}$  range corresponds with  $4000\text{ Ohms/V}$  and in the  $10\text{ mV}$  range to  $120\text{ M ohms/V}$ .

### *Effects of distorted voltages*

Although calibrated for sinusoidal voltages, the instrument will also measure voltages of which the form is not sinusoidal, without appreciable error. With 10 % harmonics, the error is less than 2 %.

### *Zero adjustment*

Mechanical

### *Calibration check*

The voltage required for checking the calibration is supplied by the instrument itself.

### *Mains fluctuations*

The variation due to a 5 % fluctuation in the mains supply is 1 %. The calibration should, if possible, be checked at the nominal voltage, since calibration may deviate  $1\frac{1}{2}$  % on a mains voltage variation of 5 %.

### *Mains supply*

A mains adapter is provided at the rear of the unit, by means of which the transformer can be strapped as required for 110, 125, 145, 200, 220 or 245 Volts, A.C.

### *Consumption*

Approx. 20 W.

### *Use with vibratory converter*

When operated in conjunction with a vibratory converter, the unit can be used on D.C. mains. For 110—145 V mains the Vibraphil Type 7710 should be used, or for 220—245 V the Vibraphil Type 7711. The voltmeter can also be fed from a 6 V car battery by means of the Vibraphil type GM 4226.

### *Valves*

R.F. Pentode	AF 7
Output triode	AC 2
Full-wave rectifier	EZ 4
Stabiliser tube	1918.

### *Dimensions*

Height	28 cm
Width	22 cm
Depth	12.5 cm.

### *Weight*

Approx. 6 kg.



## Philips stabilised voltage D.C. Supply unit type GM 4560

The need often arises for a variable source of D.C. voltage to a maximum of about 300 V which will remain constant on changing loads and fluctuating mains supply, whilst delivering a reasonable amount of power. Until recently this has been met almost exclusively by accumulators which otherwise entail many disadvantages, such as their great weight, large dimensions and constant maintenance.

Philips stabilised voltage D.C. supply unit GM 4560 for mains operation delivers a continuously variable voltage of approximately 145 V to 310 V which remains extremely constant.

Variations in the D.C. output between no-load and full-load operation are less than 0.1 V, or 0.03 %. It is very economical in use and is, moreover, always immediately ready for use, requiring no attention whatsoever. As such, it is indispensable for use in laboratories, for telegraph and telephone services, for feeding D.C. amplifiers, beat frequency oscillators, standard signal generators and for plotting the characteristics of electronic tubes.



51304

### Features

The details in the following table clearly illustrate the advantages of this unit in contrast with accumulator batteries of the same rating.

<i>Philips GM 4560</i>	<i>Accumulator battery</i>
<p>1) <i>Unusually constant</i> voltage (D.C.), even on fluctuating loads and over long periods of time.</p> <p><i>Almost complete independence of mains voltage variations and, notwithstanding the A.C. mains feed, very low ripple voltage.</i></p>	<p>The voltage depends on the discharge characteristics in accordance with the duration of use: due to the higher internal resistance, the voltage is very much more dependent on variations in the load.</p>
<p>2) <i>Continuously variable</i> D.C. voltage from approx. 145 V to 310 V.</p>	<p>The D.C. voltage can be adjusted only in stages of 2 V, or multiples thereof.</p>
<p>3) <i>Very low</i> internal resistance, viz. &lt; 1 Ohm.</p>	<p>The internal resistance is considerably higher than that of the GM 4560, being about 10 Ohms.</p>
<p>4) Shorted current automatically limited to 400 mA.</p>	<p>No automatic limitation of the current. Short circuits very detrimental to the battery.</p>

5) Simple in operation, no maintenance, mains feed and therefore low running costs; no ancillary equipment needed.	Maintenance involves regular checking, topping up with acid, cleaning, recharging and transport if necessary. Working costs are accordingly higher.
6) Dimensions $400 \times 230 \times 310$ mm. The weight is only <i>19 kg</i> . The unit is conveniently portable.	Large dimensions, great weight (approx. <i>120 kg</i> ). Dimensions of rectifier: $210 \times 240 \times 260$ mm. Weight of rectifier about <i>13 kg</i> . The complete equipment is not easy to move about.
7) It is a robust, portable instrument.	Consists of glass elements, involving risk of breakage during transport.

## OPERATION

The instrument contains the usual power section, of which the mains transformer can be adjusted to suit all mains voltages by means of an adapter; a dry H.T. battery which takes no load at all, for the grid bias; and a set of *regulator valves*.

The battery voltage is backed-off with a portion of the D.C. voltage, the difference being employed to operate the regulator valves; in this way the D.C. voltage is rendered almost completely constant and independent of the usual fluctuations in the mains supply.

## TECHNICAL DATA

### *Output current*

The maximum current available is *100 mA*; it is possible to obtain from the unit a current of which the wave-form is rectangular.

### *Short-circuit current*

Automatically limited to *400 mA*.

### *Ripple voltage*

Dependent upon the output current, the ripple voltage is approx. *2.5 mV* at *300 V*, or *1.5 mV* at *150 V*.

### *Internal resistance*

This is very low, being less than *1 Ohm*.

### *Mains variations*

For a mains voltage variation of, say, *5%*, the variation in the stabilised D.C. voltage of *300 V* is only *0.012 V*, or *0.004%*.

### *Supply*

The unit is suitable only for use on A.C. mains. A red signal lamp lights when the unit is switched on. The voltage adapter enables the unit to be used on 6 different mains voltages, namely: *110, 125, 145, 200, 220* or *245 V*  $\pm 10\%$ , *40—100 c/s*. The consumption at maximum load (*100 mA*) is about *150 W*.

### *Control range*

The D.C. voltage is variable between approximately *145 V* and *310 V*, in 10 stages of *15 V* each, a vernier with a range of *30 V* being provided so that the stages may be adequately overlapped.

### *Rectifier section*

This comprises a mains transformer, full-wave rectifier and smoothing choke with 4 Philips "Microlyte" condensers.

### *Valves*

There are in all 6 valves, viz.

EF 6 pentode  
EL 6 regulator pentode  
EL 6 regulator pentode  
7475 stabiliser tube (voltage)  
C 9 stabiliser tube (current)  
AZ 4 full-wave rectifier  
8045 D-00 signal lamp.

### *Weight*

Complete and ready for service: approx. 19 kg.

### *Dimensions*

Width 23 cm  
Height 31 cm  
Depth 40 cm (incl. knobs 43 cm).

## Philips 5000 V Supply unit GM 4198 and Projection adapter GM 4199

For use with the Philips Cathode Ray Oscilloscope GM 3156 and the Pressure Indicator GM 3154 it is sometimes desirable to have a means of increasing the intensity of the image on the screen, for instance, to project the oscillogram for demonstration purposes, or to make photographic records of transitory, isolated phenomena.

In order to obtain such high intensities of light, the intensity of the cathode ray itself is increased by means of Philips 5000 V Supply Unit GM 4198 in conjunction with a special acceleration tube (DN 9—5) which, apart from the normal electrodes found in the cathode ray tube, is fitted with a post-deflexion acceleration electrode just behind the fluorescent screen, carrying a potential of from 2 to 5 kV with respect to the cathode, or 1 to 4 kV with respect to earth. The negative electrons are accelerated by this high positive potential and, striking the screen with a much higher velocity than usual, produce a more intense light.

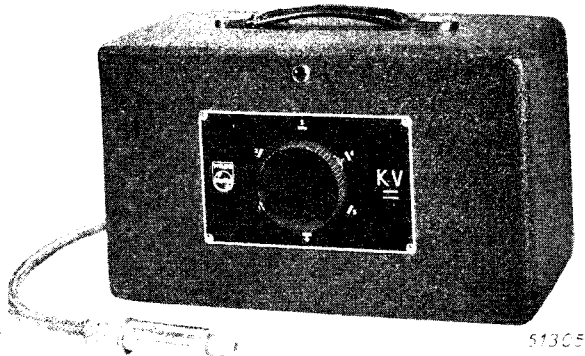

Fig. 1  
Philips 5000 V Supply Unit, GM 4198.

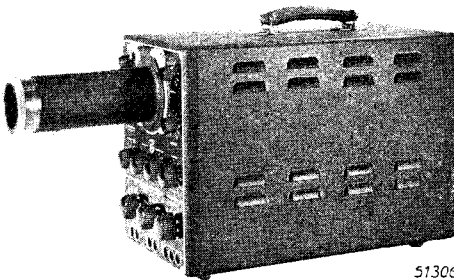

Fig. 2  
The projection adapter mounted on a Type GM 3156 Oscilloscope.

projection of oscillograms. It is easily affixed to the Oscilloscope GM 3156 or the Pressure Indicator GM 3154 and is provided with a focusing device for obtaining a sharply defined image on the projection screen.

### *Recording*

For photographic recording purposes, Philips collapsible stand, Type GM 4193 may be used, this being mounted in front of the oscilloscope in the same manner as the projection adapter.

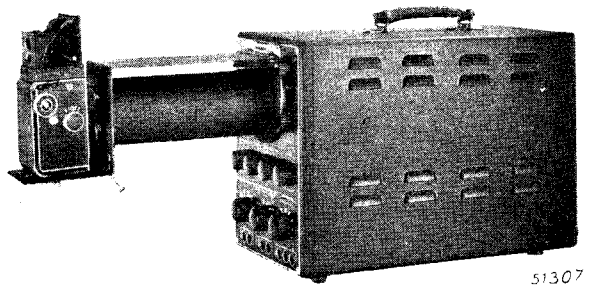

Fig. 3  
Stand, GM 4193, mounted on the Cathode Ray Oscilloscope GM 3156 and supporting a "Rolleicord" camera.

## TECHNICAL DATA

### *High tension device*

The high tension voltage may be adjusted to 1, 2, 3, 4 or 5 kV by means of a switch; the maximum current delivered is 0.1 mA, this being sufficient to feed two oscilloscopes whilst, if required, the unit can be provided with two cables for this purpose. The short circuit current is 3 mA and the unit is able to withstand this current for some time without any injurious effects.

### *Mains supply*

A voltage adapter will be found at the rear of the instrument, by means of which the transformer is adjusted as required for 110, 125, 145, 200, 220 or 245 V mains. The consumption is approximately 20 W.

### *Vibratory converter*

The supply unit can also be employed on D.C. mains, in conjunction with the "Vibra-phil" Converter Type 7710 for 110—145 V or "Vibraphil" Type 7711 for 220—245 V mains.

### *Valves*

Rectifier valve 1877.

Signal lamp 8045.

### *Construction of the 5000 V Supply Unit, GM 4198*

The high tension (5000 V) required for post-deflexion acceleration is applied to the oscilloscope by means of a cable. A control knob in the front panel operates a double pole mains switch and simultaneously controls the voltage in 5 stages from 1 to 5 kV. A red signal lamp lights immediately the unit is switched on: the latter is fully mains driven and can be quickly adapted for any mains supply voltage of from 100 to 245 V, 40—100 c/s. It is impossible to touch any parts that are at high voltage to earth. The metal case is finished in a dull black lacquer and is fitted with leather carrying handle.

### *Dimensions*

GM 4198	GM 4199
Height 18 cm	Length 18 cm
Width 29 cm	Overall diameter 10.5 cm.
Depth 17 cm (incl. controls)	

### *Weight*

GM 4198 approx. 9 kg

GM 4199 approx. 1.8 kg.

### *Projection adapter GM 4199*

The lens, of which the focal length of 150 mm, has a cross section of 62.5 mm and the projection screen may be placed at a distance of from 1 to 5 metres from the unit. At 5 m the magnification is about 30 × and at 1 m approx. 6 ×, so that an image of 2.5 cm is reproduced in a size of 15 to 75 cm. The unit can be focussed by rotating the objective holder.

## Philips "Vibraphil" vibratory converter type GM 4226

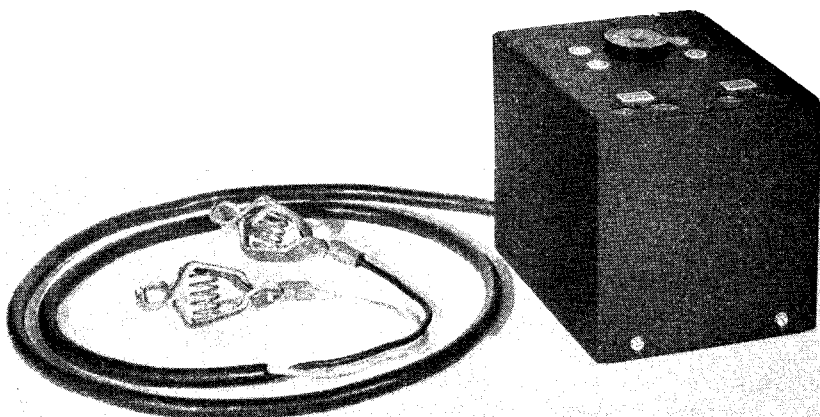

51308

Philips "Vibraphil" converter GM 4226 has been designed for the feeding of low-current apparatus from 6 V car batteries.

The converter consists of a vibrator, transformer, tuned filter and a matching switch. The direct current from the battery is converted to alternating current by the vibrator and transformer working on the well-known principle of polarity reversal or commutation and the harmonics thus produced are eliminated by a filter, tuned to the frequency of the vibrator, in conjunction with a choke and condensers.

The alternating output voltage of 220 V can be taken either direct from the vibrator or from the filter, but the former voltage contains a relatively large number of harmonics; the maximum output power is then 30 W. The form of the filtered, smoothed voltage, being more or less free from harmonics, closely approximates the sinusoidal; the output power in the case of the smoothed voltage is 18 W. The output which is to a certain extent dependent on the load, is variable up to 220 V, in stages of approx. 5 V.

### *Applications*

This unit can be employed as ancillary to the beat frequency wavemeter GM 3110, the "Philiscop" Bridge GM 4140 and the 1000 c/s Generator GM 4260. For the first of these it is not necessary to use the filtered voltage, but in the case of the Bridge GM 4140 where the test voltage is taken direct from the transformer, the filter is indispensable: the necessary voltage is then taken from the sockets mounted just behind the filter. When the GM 4260 is used in conjunction with GM 4140, the raw voltage may be used.

### **TECHNICAL DATA**

#### *Output power*

The maximum amount of power supplied by the vibrator unit is 30 W when the voltage is taken direct from the vibrator and 18 W when drawn from the filter.

### *Current consumption*

The amount of current taken from the battery is dependent upon the load; at full load it is 6 A at 6 V.

### *Connections*

For connection to the 6 V battery, the unit is equipped with a rubber-covered cable carrying two battery clips; it is not necessary to take polarity into account. The alternating current is taken from two pairs of sockets, one of which is for the filtered current and one for the unfiltered.

### *Dimensions*

13 × 10.5 × 11.5 cm.

### *Weight*

Approx. 3 kg.